

OM55N10SC OM60N10SC OM75N05SC OM75N06SC
 OM55N10SA OM75N05SA OM75N06SA

LOW VOLTAGE, LOW $R_{DS(on)}$ POWER MOSFETS IN HERMETIC ISOLATED PACKAGE

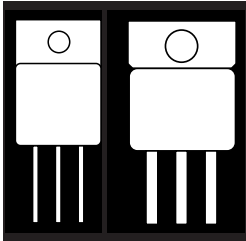

50V, 60V, And 100V Ultra Low $R_{DS(on)}$
 Power MOSFETs In TO-254 And TO-258
 Isolated Packages

FEATURES

- Isolated Hermetic Metal Packages
- Ultra Low $R_{DS(on)}$
- Low Conductive Loss/Low Gate Charge
- Available Screened To MIL-S-19500, TX, TXV And S Levels
- Ceramic Feedthroughs available

DESCRIPTION

This series of hermetic packaged MOSFETs are ideally suited for low voltage applications; battery powered voltage power supplies, motor controls, dc to dc converters and synchronous rectification. The low conduction loss allows smaller heat sinking and the low gate change simpler drive circuitry.

MAXIMUM RATINGS (Per Device)

PART NO.	V_{DS} (V)	$R_{DS(on)}$ ()	I_D (A)	Package
OM60N10SC	100	.025	60	TO-258AA
OM55N10SC	100	.030	55	TO-258AA
OM55N10SA	100	.035	55	TO-254AA
OM75N06SC	60	.016	75	TO-258AA
OM75N06SA	60	.018	75	TO-254AA
OM75N05SC	50	.016	75	TO-258AA
OM75N05SA	50	.018	75	TO-254AA

3.1

SCHEMATIC

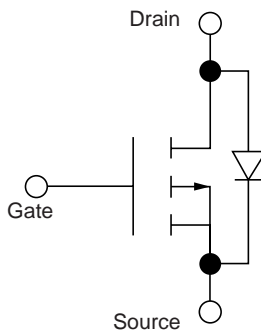

PIN CONNECTION

TO-254AA

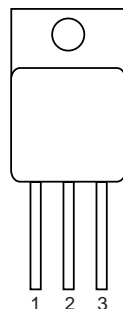

Pin 1: Drain
 Pin 2: Source
 Pin 3: Gate

TO-258AA

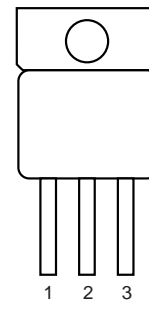

Pin 1: Drain
 Pin 2: Source
 Pin 3: Gate

OM55N10SA - OM75N06SC

ABSOLUTE MAXIMUM RATINGS ($T_C = 25^\circ\text{C}$ unless otherwise noted)

Parameter	60N10SC	55N10SA 55N10SC	75N06SA 75N06SC	75N05SA 75N05SC	Units
V_{DS}	100	100	60	50	V
V_{DGR}	100	100	60	50	V
$I_D @ T_C = 25^\circ\text{C}$	60	55	75	75	A
$I_D @ T_C = 100^\circ\text{C}$	37	33	45	45	A
I_{DM}	180	180	225	225	A
$P_D @ T_C = 25^\circ\text{C}$	130	125	125	125	W
$P_D @ T_C = 100^\circ\text{C}$	55	50	50	50	W
Junction-To-Case	1.00	1.00	1.00	1.00	W/ $^\circ\text{C}$
T_J	Operating and				$^\circ\text{C}$
T_{stg}	Storage Temperature Range				
Lead Temperature (1/16" from case for 10 secs.)	300	300	300	300	$^\circ\text{C}$

1 Pulse Test: Pulse width 300 μsec . Duty Cycle 1.5%.

2 Package Limited: SA $I_o = 25\text{A}$ & SC $I_o = 35\text{A}$ @ 25°C

THERMAL RESISTANCE

R_{thJC}	Junction-to-Case	1.0	$^\circ\text{C}/\text{W}$
------------	------------------	-----	---------------------------

PACKAGE LIMITATIONS

Parameters	TO254AA	TO-258AA	Unit
I_D	25	35	A
Linear Derating Factor, Junction-to-Ambient	.020	.025	W/ $^\circ\text{C}$
R_{thJA}	50	40	$^\circ\text{C}/\text{W}$

MECHANICAL OUTLINE

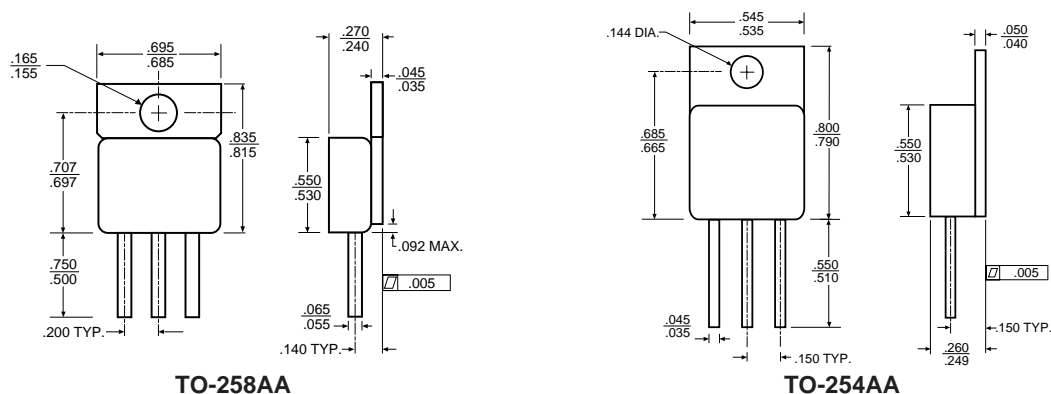

TO-258AA

TO-254AA

PACKAGE OPTIONS

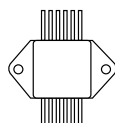

MOD PAK

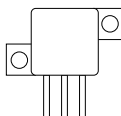

Z-TAB

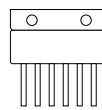

6 PIN SIP

Note: MOSFETs are also available in Z-Tab, dual and quad pak styles. Duals and quads available in non-gate versions only. Please call the factory for more information.

OM60N10SC ($T_C = 25^\circ\text{C}$ unless otherwise specified)

OM55N10SC ($T_C = 25^\circ\text{C}$ unless otherwise specified)

Avalanche Characteristics		Min.	Typ.	Max.	Units	Test Conditions
I_{AR}	Avalanche Current			60	A	(repetitive or non-repetitive, $T_J = 25^\circ\text{C}$)
E_{AS}	Single Pulse Avalanche Energy			720	mJ	(starting $T_J = 25^\circ\text{C}$, $I_D = I_{AR}$, $V_{DD} = 25\text{ V}$)
E_{AR}	Repetitive Avalanche Energy			100	mJ	(pulse width limited by $T_{I,max}$, $d < 1\%$)
I_{AR}	Avalanche Current			37	A	(repetitive or non-repetitive, $T_J = 100^\circ\text{C}$)
Electrical Characteristics - OFF						
$V_{(BR)DSS}$	Drain-Source Breakdown Voltage	100			V	$I_D = 250\ \mu\text{A}$, $V_{GS} = 0$
I_{DSS}	Zero Gate Voltage Drain Current ($V_{GS} = 0$)			250 1000	μA	$V_{DS} = \text{Max. Rat.}$ $V_{DS} = \text{Max. Rat.} \times 0.8$, $T_C = 125^\circ\text{C}$
I_{GSS}	Gate-Body Leakage Current ($V_{DS} = 0$)			± 100	nA	$V_{GS} = \pm 20\text{ V}$
Electrical Characteristics - ON*						
$V_{GS(th)}$	Gate Threshold Voltage	2		4	V	$V_{DS} = V_{GS}$, $I_D = 250\ \mu\text{A}$
$R_{DS(on)}$	Static Drain-Source On Resistance			0.025 0.05		$V_{GS} = 10\text{ V}$, $I_D = 30\text{ A}$ $T_C = 100^\circ\text{C}$
$I_{D(on)}$	On State Drain Current	60			A	$V_{DS} > I_{D(on)} \times R_{DS(on)max}$, $V_{GS} = 10\text{ V}$
Electrical Characteristics - Dynamic						
g_{fs}	Forward Transconductance	25			S	$V_{DS} > I_{D(on)} \times R_{DS(on)max}$, $I_D = 30\text{ A}$
C_{ies}	Input Capacitance		4000		pF	$V_{DS} = 25\text{ V}$
C_{oes}	Output Capacitance		1100		pF	$V_{GS} = 0$
C_{res}	Reverse Transfer Capacitance		250		pF	$f = 1\text{ MHz}$
Electrical Characteristics - Switching On						
$T_{d(on)}$	Turn-On Time		90		nS	$V_{DS} = 80\text{ V}$, $I_D = 30\text{ A}$
t_r	Rise Time		270		nS	$R_G = 50$, $V_{GS} = 10\text{ V}$
$(di/dt)_{on}$	Turn-On Current Slope		270		A/ μS	$V_{DS} = 80\text{ V}$, $I_D = 30\text{ A}$ $R_G = 50$, $V_{GS} = 10\text{ V}$
Q_g	Total Gate Charge		120		nC	$V_{DS} = 80\text{ V}$, $I_D = 30\text{ A}$, $V_{GS} = 10\text{ V}$
Electrical Characteristics - Switching Off						
$T_{r(off)}$	Off Voltage Rise Time		200		nS	$V_{DS} = 80\text{ V}$, $I_D = 30\text{ A}$
t_f	Fall Time		210		nS	$R_G = 50$, $V_{GS} = 10\text{ V}$
t_{cross}	Cross-Over Time		410		nS	
Electrical Characteristics - Source Drain Diode						
I_{SD}	Source Drain Current			60	A	
I_{SDM}^*	Source Drain Current (pulsed)			240	A	
V_{SD}	Forward On Voltage			1.6	V	$I_{SD} = 60\text{ A}$, $V_{GS} = 0$
t_{rr}	Reverse Recovery Time		180		nS	$I_{SD} = 60\text{ A}$, $di/dt = 100\text{ A}/\mu\text{s}$ $V_R = 80\text{ V}$
Q_{rr}	Reverse Recovery Charge		1.8		μC	
I_{RRM}	Reverse Recovery Current		10		A	

*Pulsed: Pulse Duration 300 μs , Duty Cycle 1.5%.

Avalanche Characteristics		Min.	Typ.	Max.	Units	Test Conditions
I_{AR}	Avalanche Current			55	A	(repetitive or non-repetitive, $T_J = 25^\circ\text{C}$)
E_{AS}	Single Pulse Avalanche Energy			600	mJ	(starting $T_J = 25^\circ\text{C}$, $I_D = I_{AR}$, $V_{DD} = 25\text{ V}$)
E_{AR}	Repetitive Avalanche Energy			100	mJ	(pulse width limited by $T_{I,max}$, $d < 1\%$)
I_{AR}	Avalanche Current			37	A	(repetitive or non-repetitive, $T_J = 100^\circ\text{C}$)
Electrical Characteristics - OFF						
$V_{(BR)DSS}$	Drain-Source Breakdown Voltage	100			V	$I_D = 250\ \mu\text{A}$, $V_{GS} = 0$
I_{DSS}	Zero Gate Voltage Drain Current ($V_{GS} = 0$)			250 1000	μA	$V_{DS} = \text{Max. Rat.}$ $V_{DS} = \text{Max. Rat.} \times 0.8$, $T_C = 125^\circ\text{C}$
I_{GSS}	Gate-Body Leakage Current ($V_{DS} = 0$)			± 100	nA	$V_{GS} = \pm 20\text{ V}$
Electrical Characteristics - ON*						
$V_{GS(th)}$	Gate Threshold Voltage	2		4	V	$V_{DS} = V_{GS}$, $I_D = 250\ \mu\text{A}$
$R_{DS(on)}$	Static Drain-Source On Resistance			0.03 0.06		$V_{GS} = 10\text{ V}$, $I_D = 30\text{ A}$ $T_C = 100^\circ\text{C}$
$I_{D(on)}$	On State Drain Current	55			A	$V_{DS} > I_{D(on)} \times R_{DS(on)max}$, $V_{GS} = 10\text{ V}$
Electrical Characteristics - Dynamic						
g_{fs}	Forward Transconductance	25			S	$V_{DS} > I_{D(on)} \times R_{DS(on)max}$, $I_D = 30\text{ A}$
C_{ies}	Input Capacitance		4000		pF	$V_{DS} = 25\text{ V}$
C_{oes}	Output Capacitance		1100		pF	$V_{GS} = 0$
C_{res}	Reverse Transfer Capacitance		250		pF	$f = 1\text{ MHz}$
Electrical Characteristics - Switching On						
$T_{d(on)}$	Turn-On Time		90		nS	$V_{DS} = 80\text{ V}$, $I_D = 30\text{ A}$
t_r	Rise Time		270		nS	$R_G = 50$, $V_{GS} = 10\text{ V}$
$(di/dt)_{on}$	Turn-On Current Slope		270		A/ μS	$V_{DS} = 80\text{ V}$, $I_D = 30\text{ A}$ $R_G = 50$, $V_{GS} = 10\text{ V}$
Q_g	Total Gate Charge		120		nC	$V_{DS} = 80\text{ V}$, $I_D = 30\text{ A}$, $V_{GS} = 10\text{ V}$
Electrical Characteristics - Switching Off						
$T_{r(off)}$	Off Voltage Rise Time		200		nS	$V_{DS} = 80\text{ V}$, $I_D = 30\text{ A}$
t_f	Fall Time		210		nS	$R_G = 50$, $V_{GS} = 10\text{ V}$
t_{cross}	Cross-Over Time		410		nS	
Electrical Characteristics - Source Drain Diode						
I_{SD}	Source Drain Current			55	A	
I_{SDM}^*	Source Drain Current (pulsed)			220	A	
V_{SD}	Forward On Voltage			1.5	V	$I_{SD} = 55\text{ A}$, $V_{GS} = 0$
t_{rr}	Reverse Recovery Time		180		nS	$I_{SD} = 55\text{ A}$, $di/dt = 100\text{ A}/\mu\text{s}$ $V_R = 80\text{ V}$
Q_{rr}	Reverse Recovery Charge		1.8		μC	
I_{RRM}	Reverse Recovery Current		11		A	

*Pulsed: Pulse Duration 300 μs , Duty Cycle 1.5%.

OM55N10SA ($T_C = 25^\circ\text{C}$ unless otherwise specified)

Avalanche Characteristics		Min.	Typ.	Max.	Units	Test Conditions
I_{AR}	Avalanche Current			55	A	(repetitive or non-repetitive, $T_J = 25^\circ\text{C}$)
E_{AS}	Single Pulse Avalanche Energy			600	mJ	(starting $T_J = 25^\circ\text{C}$, $I_D = I_{AR}$, $V_{DD} = 25\text{ V}$)
E_{AR}	Repetitive Avalanche Energy			100	mJ	(pulse width limited by $T_{I,max}$, $d_i < 1\%$)
I_{AR}	Avalanche Current			37	A	(repetitive or non-repetitive, $T_J = 100^\circ\text{C}$)
Electrical Characteristics - OFF						
$V_{(BR)DSS}$	Drain-Source Breakdown Voltage	100			V	$I_D = 250\ \mu\text{A}$, $V_{GS} = 0$
I_{DSS}	Zero Gate Voltage Drain Current ($V_{GS} = 0$)			250 1000	μA μA	$V_{DS} = \text{Max. Rat.}$ $V_{DS} = \text{Max. Rat.} \times 0.8$, $T_C = 125^\circ\text{C}$
I_{GSS}	Gate-Body Leakage Current ($V_{DS} = 0$)			± 100	nA	$V_{GS} = \pm 20\text{ V}$
Electrical Characteristics - ON						
$V_{GS(th)}$	Gate Threshold Voltage	2		4	V	$V_{DS} = V_{GS}$, $I_D = 250\ \mu\text{A}$
$R_{DS(on)}$	Static Drain-Source On Resistance			0.035 0.070		$V_{GS} = 10\text{ V}$, $I_D = 30\text{ A}$ $T_C = 100^\circ\text{C}$
$I_{D(on)}$	On State Drain Current	55			A	$V_{DS} > I_{D(on)} \times R_{DS(on)max}$, $V_{GS} = 10\text{ V}$
Electrical Characteristics - Dynamic						
g_{fs}	Forward Transconductance	25			S	$V_{DS} > I_{D(on)} \times R_{DS(on)max}$, $I_D = 30\text{ A}$
C_{ies}	Input Capacitance		4000		pF	$V_{DS} = 25\text{ V}$
C_{oes}	Output Capacitance		1100		pF	$V_{GS} = 0$
C_{res}	Reverse Transfer Capacitance		250		pF	$f = 1\text{ MHz}$
Electrical Characteristics - Switching On						
$T_{d(on)}$	Turn-On Time		90		nS	$V_{DD} = 80\text{ V}$, $I_D = 30\text{ A}$
t_r	Rise Time		270		nS	$R_G = 50$, $V_{GS} = 10\text{ V}$
$(di/dt)_{on}$	Turn-On Current Slope		270		A/ μS	$V_{DD} = 80\text{ V}$, $I_D = 30\text{ A}$ $R_G = 50$, $V_{GS} = 10\text{ V}$
Q_g	Total Gate Charge		120		nC	$V_{DD} = 80\text{ V}$, $I_D = 30\text{ A}$, $V_{GS} = 10\text{ V}$
Electrical Characteristics - Switching Off						
$T_{r(off)}$	Off Voltage Rise Time		200		nS	$V_{DD} = 80\text{ V}$, $I_D = 30\text{ A}$
t_f	Fall Time		210		nS	$R_G = 50$, $V_{GS} = 10\text{ V}$
t_{cross}	Cross-Over Time		410		nS	
Electrical Characteristics - Source Drain Diode						
I_{SD}	Source Drain Current			55	A	
I_{SDM}^*	Source Drain Current (pulsed)			180	A	
V_{SD}	Forward On Voltage			1.5	V	$I_{SD} = 55\text{ A}$, $V_{GS} = 0$
t_{rr}	Reverse Recovery Time		180		nS	$I_{SD} = 55\text{ A}$, $di/dt = 100\text{ A}/\mu\text{s}$ $V_R = 80\text{ V}$
Q_{rr}	Reverse Recovery Charge		1.8		μC	
I_{RRM}	Reverse Recovery Current		11		A	

*Pulsed: Pulse Duration 300 μS , Duty Cycle 1.5%.

OM75N06SC ($T_C = 25^\circ\text{C}$ unless otherwise specified)

Avalanche Characteristics		Min.	Typ.	Max.	Units	Test Conditions
I_{AR}	Avalanche Current			70	A	(repetitive or non-repetitive, $T_J = 25^\circ\text{C}$)
E_{AS}	Single Pulse Avalanche Energy			900	mJ	(starting $T_J = 25^\circ\text{C}$, $I_D = I_{AR}$, $V_{DD} = 25\text{ V}$)
E_{AR}	Repetitive Avalanche Energy			200	mJ	(pulse width limited by $T_{I,max}$, $d_i < 1\%$)
I_{AR}	Avalanche Current			40	A	(repetitive or non-repetitive, $T_J = 100^\circ\text{C}$)
Electrical Characteristics - OFF						
$V_{(BR)DSS}$	Drain-Source Breakdown Voltage	60			V	$I_D = 250\ \mu\text{A}$, $V_{GS} = 0$
I_{DSS}	Zero Gate Voltage Drain Current ($V_{GS} = 0$)			250 1000	μA μA	$V_{DS} = \text{Max. Rat.}$ $V_{DS} = \text{Max. Rat.} \times 0.8$, $T_C = 125^\circ\text{C}$
I_{GSS}	Gate-Body Leakage Current ($V_{DS} = 0$)			± 100	nA	$V_{GS} = \pm 20\text{ V}$
Electrical Characteristics - ON						
$V_{GS(th)}$	Gate Threshold Voltage	2		4	V	$V_{DS} = V_{GS}$, $I_D = 250\ \mu\text{A}$
$R_{DS(on)}$	Static Drain-Source On Resistance			0.016 0.032		$V_{GS} = 10\text{ V}$, $I_D = 40\text{ A}$ $T_C = 100^\circ\text{C}$
$I_{D(on)}$	On State Drain Current	75			A	$V_{DS} > I_{D(on)} \times R_{DS(on)max}$, $V_{GS} = 10\text{ V}$
Electrical Characteristics - Dynamic						
g_{fs}	Forward Transconductance	25			S	$V_{DS} > I_{D(on)} \times R_{DS(on)max}$, $I_D = 40\text{ A}$
C_{ies}	Input Capacitance		4100		pF	$V_{DS} = 25\text{ V}$
C_{oes}	Output Capacitance		1800		pF	$V_{GS} = 0$
C_{res}	Reverse Transfer Capacitance		420		pF	$f = 1\text{ MHz}$
Electrical Characteristics - Switching On						
$T_{d(on)}$	Turn-On Time		190		nS	$V_{DD} = 25\text{ V}$, $I_D = 40\text{ A}$
t_r	Rise Time		900		nS	$R_G = 50$, $V_{GS} = 10\text{ V}$
$(di/dt)_{on}$	Turn-On Current Slope		150		A/ μS	$V_{DD} = 25\text{ V}$, $I_D = 40\text{ A}$ $R_G = 50$, $V_{GS} = 10\text{ V}$
Q_g	Total Gate Charge		130		nC	$V_{DD} = 25\text{ V}$, $I_D = 40\text{ A}$, $V_{GS} = 10\text{ V}$
Electrical Characteristics - Switching Off						
$T_{r(off)}$	Off Voltage Rise Time		360		nS	$V_{DD} = 40\text{ V}$, $I_D = 75\text{ A}$
t_f	Fall Time		280		nS	$R_G = 50$, $V_{GS} = 10\text{ V}$
t_{cross}	Cross-Over Time		600		nS	
Electrical Characteristics - Source Drain Diode						
I_{SD}	Source Drain Current			75	A	
I_{SDM}^*	Source Drain Current (pulsed)			300	A	
V_{SD}	Forward On Voltage			1.5	V	$I_{SD} = 75\text{ A}$, $V_{GS} = 0$
t_{rr}	Reverse Recovery Time		120		nS	$I_{SD} = 75\text{ A}$, $di/dt = 100\text{ A}/\mu\text{s}$ $V_R = 25\text{ V}$
Q_{rr}	Reverse Recovery Charge		0.45		μC	
I_{RRM}	Reverse Recovery Current		6.5		A	

*Pulsed: Pulse Duration 300 μS , Duty Cycle 1.5%.

OM75N06SA (T_C = 25°C unless otherwise specified)

OM75N05SC (T_C = 25°C unless otherwise specified)

Avalanche Characteristics		Min.	Typ.	Max.	Units	Test Conditions
I _{AR}	Avalanche Current			70	A	(repetitive or non-repetitive, T _J = 25°C)
E _{AS}	Single Pulse Avalanche Energy			900	mJ	(starting T _J = 25°C, I _b = I _{AR} , V _{DD} = 25 V)
E _{AR}	Repetitive Avalanche Energy			200	mJ	(pulse width limited by T _{Jmax} , d < 1%)
I _{AR}	Avalanche Current			40	A	(repetitive or non-repetitive, T _J = 100°C)
Electrical Characteristics - OFF						
V _{(BR)DSS}	Drain-Source Breakdown Voltage	60			V	I _b = 250 μA, V _{GS} = 0
I _{DSS}	Zero Gate Voltage Drain Current (V _{GS} = 0)			250 1000	μA	V _{DS} = Max. Rat. V _{DS} = Max. Rat. x 0.8, T _C = 125°C
I _{GSS}	Gate-Body Leakage Current (V _{GS} = 0)			±100	nA	V _{GS} = ±20 V
Electrical Characteristics - ON*						
V _{GS(th)}	Gate Threshold Voltage	2		4	V	V _{DS} = V _{GS} , I _b = 250 μA
R _{DS(on)}	Static Drain-Source On Resistance			0.018 0.036		V _{GS} = 10 V, I _b = 40 A T _C = 100°C
I _{D(on)}	On State Drain Current	75			A	V _{DS} > I _{D(on)} x R _{DS(on)max} , V _{GS} = 10 V
Electrical Characteristics - Dynamic						
g _{fs}	Forward Transconductance	25			S	V _{DS} > I _{D(on)} x R _{DS(on)max} , I _b = 40 A
C _{iss}	Input Capacitance		4100		pF	V _{DS} = 25 V
C _{oss}	Output Capacitance		1800		pF	V _{GS} = 0
C _{res}	Reverse Transfer Capacitance		420		pF	f = 1 MHz
Electrical Characteristics - Switching On						
T _{d(on)}	Turn-On Time		190		nS	V _{DD} = 25 V, I _b = 40 A
t _r	Rise Time		900		nS	R _G = 50 , V _{GS} = 10 V
(di/dt) _{on}	Turn-On Current Slope		150		A/μS	V _{DD} = 25 V, I _b = 40 A R _G = 50 , V _{GS} = 10 V
Q _g	Total Gate Charge		130		nC	V _{DD} = 25 V, I _b = 40 A, V _{GS} = 10 V
Electrical Characteristics - Switching Off						
T _{r(Voff)}	Off Voltage Rise Time		360		nS	V _{DD} = 40 V, I _b = 75 A
t _f	Fall Time		280		nS	R _G = 50 , V _{GS} = 10 V
t _{cross}	Cross-Over Time		600		nS	
Electrical Characteristics - Source Drain Diode						
I _{SD}	Source Drain Current			75	A	
I _{SDM} *	Source Drain Current (pulsed)			300	A	
V _{SD}	Forward On Voltage			1.5	V	I _{SD} = 75 A, V _{GS} = 0
t _{rr}	Reverse Recovery Time		120		nS	I _{SD} = 75 A, di/dt = 100 A/μs V _R = 25 V
Q _{rr}	Reverse Recovery Charge		0.45		μC	
I _{RRM}	Reverse Recovery Current		6.5		A	

*Pulsed: Pulse Duration 300μS, Duty Cycle 1.5%.

Avalanche Characteristics		Min.	Typ.	Max.	Units	Test Conditions
I _{AR}	Avalanche Current			70	A	(repetitive or non-repetitive, T _J = 25°C)
E _{AS}	Single Pulse Avalanche Energy			900	mJ	(starting T _J = 25°C, I _b = I _{AR} , V _{DD} = 25 V)
E _{AR}	Repetitive Avalanche Energy			200	mJ	(pulse width limited by T _{Jmax} , d < 1%)
I _{AR}	Avalanche Current			40	A	(repetitive or non-repetitive, T _J = 100°C)
Electrical Characteristics - OFF						
V _{(BR)DSS}	Drain-Source Breakdown Voltage	50			V	I _b = 250 μA, V _{GS} = 0
I _{DSS}	Zero Gate Voltage Drain Current (V _{GS} = 0)			250 1000	μA	V _{DS} = Max. Rat. V _{DS} = Max. Rat. x 0.8, T _C = 125°C
I _{GSS}	Gate-Body Leakage Current (V _{GS} = 0)			±100	nA	V _{GS} = ±20 V
Electrical Characteristics - ON*						
V _{GS(th)}	Gate Threshold Voltage	2		4	V	V _{DS} = V _{GS} , I _b = 250 μA
R _{DS(on)}	Static Drain-Source On Resistance			0.016 0.032		V _{GS} = 10 V, I _b = 40 A T _C = 100°C
I _{D(on)}	On State Drain Current	75			A	V _{DS} > I _{D(on)} x R _{DS(on)max} , V _{GS} = 10 V
Electrical Characteristics - Dynamic						
g _{fs}	Forward Transconductance	25			S	V _{DS} > I _{D(on)} x R _{DS(on)max} , I _b = 40 A
C _{iss}	Input Capacitance		4100		pF	V _{DS} = 25 V
C _{oss}	Output Capacitance		1800		pF	V _{GS} = 0
C _{res}	Reverse Transfer Capacitance		420		pF	f = 1 MHz
Electrical Characteristics - Switching On						
T _{d(on)}	Turn-On Time		190		nS	V _{DD} = 20 V, I _b = 40 A
t _r	Rise Time		900		nS	R _G = 50 , V _{GS} = 10 V
(di/dt) _{on}	Turn-On Current Slope		150		A/μS	V _{DD} = 20 V, I _b = 40 A R _G = 50 , V _{GS} = 10 V
Q _g	Total Gate Charge		130		nC	V _{DD} = 20 V, I _b = 40 A, V _{GS} = 10 V
Electrical Characteristics - Switching Off						
T _{r(Voff)}	Off Voltage Rise Time		360		nS	V _{DD} = 35 V, I _b = 75 A
t _f	Fall Time		280		nS	R _G = 50 , V _{GS} = 10 V
t _{cross}	Cross-Over Time		600		nS	
Electrical Characteristics - Source Drain Diode						
I _{SD}	Source Drain Current			75	A	
I _{SDM} *	Source Drain Current (pulsed)			300	A	
V _{SD}	Forward On Voltage			1.5	V	I _{SD} = 75 A, V _{GS} = 0
t _{rr}	Reverse Recovery Time		120		nS	I _{SD} = 75 A, di/dt = 100 A/μs V _R = 20 V
Q _{rr}	Reverse Recovery Charge		0.45		μC	
I _{RRM}	Reverse Recovery Current		6.5		A	

*Pulsed: Pulse Duration 300μS, Duty Cycle 1.5%.

OM75N05SA ($T_C = 25^\circ\text{C}$ unless otherwise specified)

Avalanche Characteristics		Min.	Typ.	Max.	Units	Test Conditions
I_{AR}	Avalanche Current			70	A	(repetitive or non-repetitive, $T_J = 25^\circ\text{C}$)
E_{AS}	Single Pulse Avalanche Energy			900	mJ	(starting $T_J = 25^\circ\text{C}$, $I_D = I_{AR}$, $V_{DD} = 25\text{ V}$)
E_{AR}	Repetitive Avalanche Energy			200	mJ	(pulse width limited by T_{Jmax} , $d < 1\%$)
I_{AR}	Avalanche Current			40	A	(repetitive or non-repetitive, $T_J = 100^\circ\text{C}$)
Electrical Characteristics - OFF						
$V_{BR(DSS)}$	Drain-Source Breakdown Voltage	50			V	$I_D = 250\ \mu\text{A}$, $V_{GS} = 0$
I_{DSS}	Zero Gate Voltage Drain Current ($V_{GS} = 0$)			250 1000	μA	$V_{DS} = \text{Max. Rat.}$ $V_{DS} = \text{Max. Rat.} \times 0.8$, $T_C = 125^\circ\text{C}$
I_{GSS}	Gate-Body Leakage Current ($V_{DS} = 0$)			± 100	nA	$V_{GS} = \pm 20\text{ V}$
Electrical Characteristics - ON						
$V_{GS(th)}$	Gate Threshold Voltage	2		4	V	$V_{DS} = V_{GS}$, $I_D = 250\ \mu\text{A}$
$R_{DS(on)}$	Static Drain-Source On Resistance			0.018 0.036		$V_{GS} = 10\text{ V}$, $I_D = 40\text{ A}$ $T_C = 100^\circ\text{C}$
$I_{D(on)}$	On State Drain Current	75			A	$V_{DS} > I_{D(on)} \times R_{DS(on)max}$, $V_{GS} = 10\text{ V}$
Electrical Characteristics - Dynamic						
g_{fs}	Forward Transconductance	25			S	$V_{DS} > I_{D(on)} \times R_{DS(on)max}$, $I_D = 40\text{ A}$
C_{iss}	Input Capacitance		4100		pF	$V_{DS} = 25\text{ V}$
C_{oss}	Output Capacitance		1800		pF	$V_{GS} = 0$
C_{riss}	Reverse Transfer Capacitance		420		pF	$f = 1\text{ MHz}$
Electrical Characteristics - Switching On						
$T_{d(on)}$	Turn-On Time		190		nS	$V_{DD} = 20\text{ V}$, $I_D = 40\text{ A}$
t_r	Rise Time		900		nS	$R_G = 50$, $V_{GS} = 10\text{ V}$
$(di/dt)_{on}$	Turn-On Current Slope		150		A/ μS	$V_{DD} = 20\text{ V}$, $I_D = 40\text{ A}$ $R_G = 50$, $V_{GS} = 10\text{ V}$
Q_g	Total Gate Charge		130		nC	$V_{DD} = 20\text{ V}$, $I_D = 40\text{ A}$, $V_{GS} = 10\text{ V}$
Electrical Characteristics - Switching Off						
$T_{r(off)}$	Off Voltage Rise Time		360		nS	$V_{DD} = 35\text{ V}$, $I_D = 75\text{ A}$
t_f	Fall Time		280		nS	$R_G = 50$, $V_{GS} = 10\text{ V}$
t_{cross}	Cross-Over Time		600		nS	
Electrical Characteristics - Source Drain Diode						
I_{SD}	Source Drain Current			75	A	
I_{SDM}^*	Source Drain Current (pulsed)			300	A	
V_{SD}	Forward On Voltage			1.5	V	$I_{SD} = 75\text{ A}$, $V_{GS} = 0$
t_{rr}	Reverse Recovery Time		120		nS	$I_{SD} = 75\text{ A}$, $di/dt = 100\text{ A}/\mu\text{s}$ $V_R = 20\text{ V}$
Q_{rr}	Reverse Recovery Charge		0.45		μC	
I_{RRM}	Reverse Recovery Current		6.5		A	

*Pulsed: Pulse Duration 300 μs , Duty Cycle 1.5%.

SWITCHING TIMES TEST CIRCUITS FOR RESISTIVE LOAD

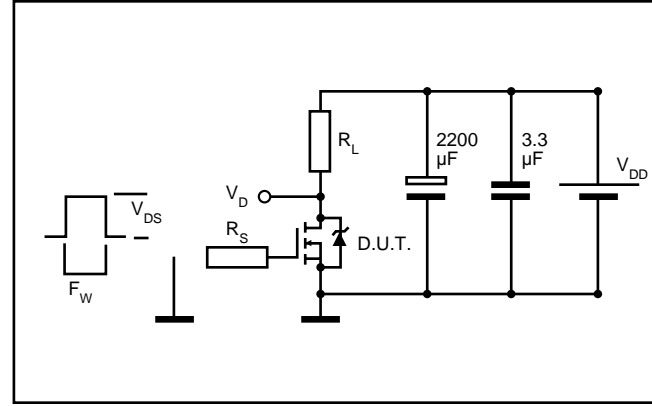

TEST CIRCUIT FOR INDUCTIVE LOAD SWITCHING AND DIODE REVERSE RECOVERY TIME

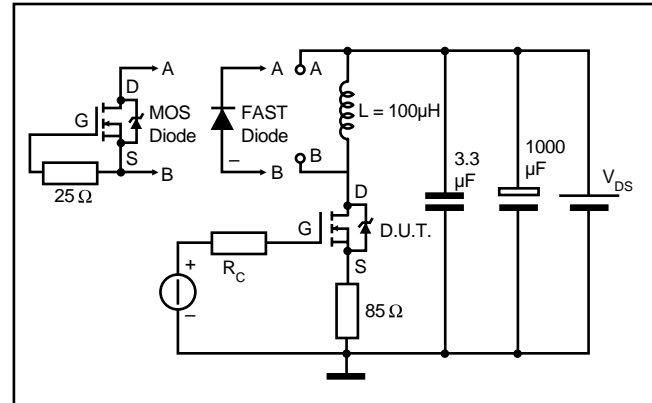

OM75N06SC, OM75N06SA, OM75N05SC, OM75N05SA

Transconductance

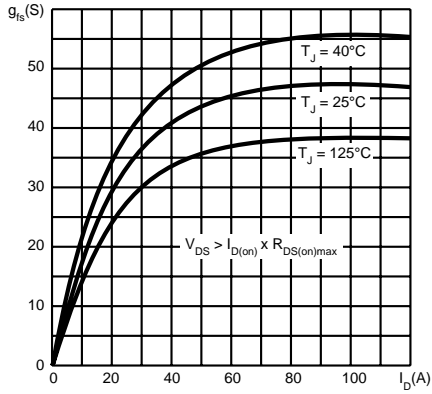

Static Drain-Source On Resistance

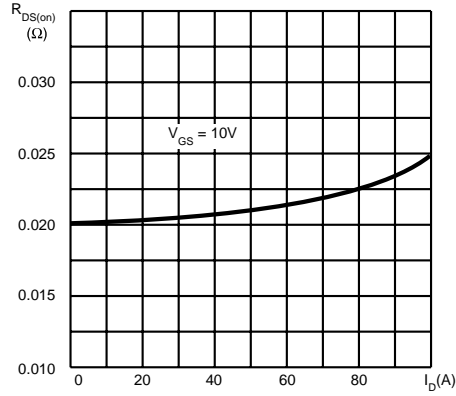

Gate Charge vs Gate-Source Voltage

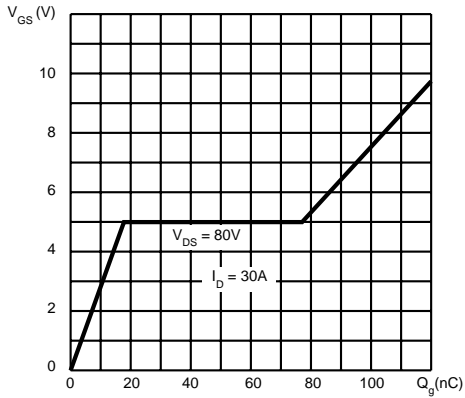

Capacitance Variations

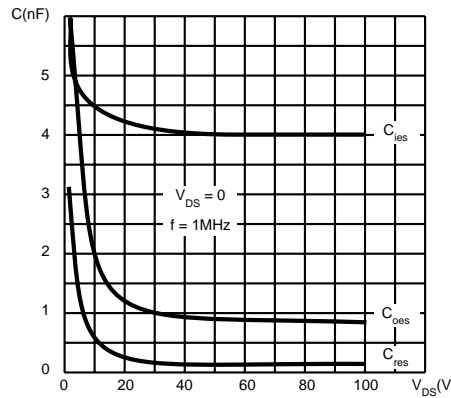

3.1

Normalized Gate Threshold Voltage vs Temperature

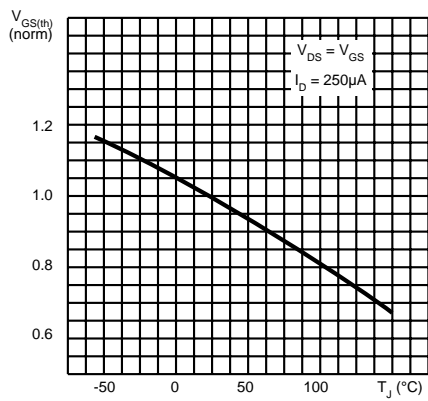

Normalized On Resistance vs Temperature

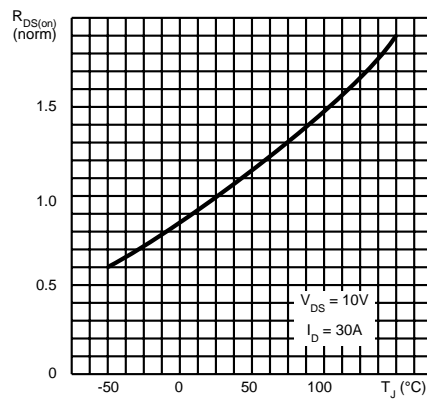

OM75N06SC, OM75N06SA, OM75N05SC, OM75N05SA

Transconductance

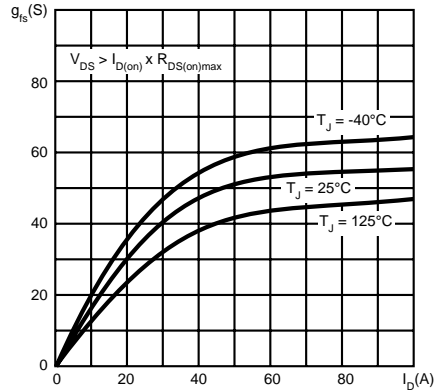

Static Drain-Source On Resistance

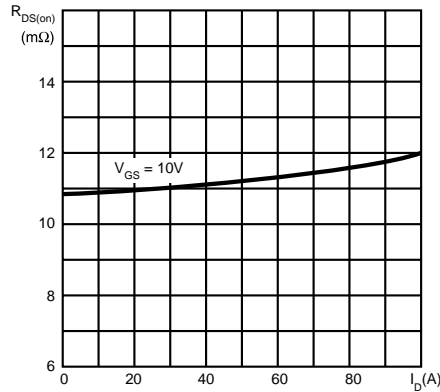

Gate Charge vs Gate-Source Voltage

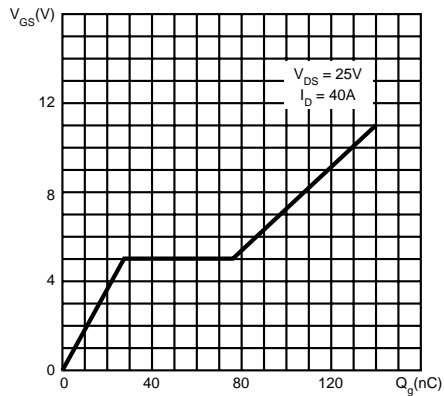

Capacitance Variations

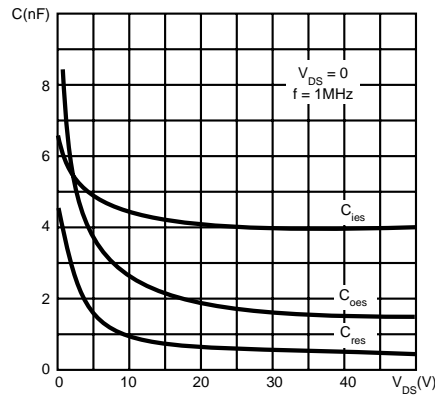

Normalized Gate Threshold Voltage vs Temperature

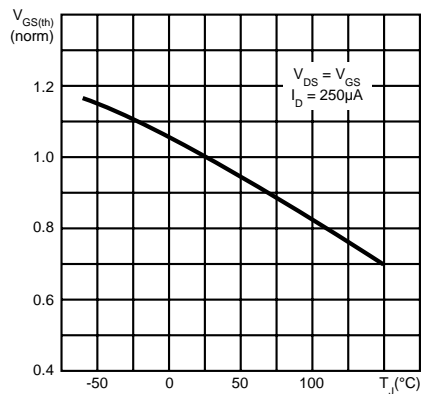

Normalized On Resistance vs Temperature

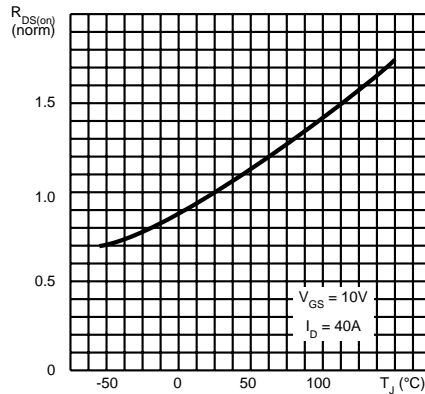

3.1