

AFL270XXS SERIES

270V Input, Single Output

HYBRID-HIGH RELIABILITY DC/DC CONVERTER

Description

The AFL Series of DC/DC converters feature high power density with no derating over the full military temperature range. This series is offered as part of a complete family of converters providing single and dual output voltages and operating from nominal +28V or +270V inputs with output power ranging from 80W to 120W. For applications requiring higher output power, multiple converters can be operated in parallel. The internal current sharing circuits assure equal current distribution among the paralleled converters. This series incorporates International Rectifier's proprietary magnetic pulse feedback technology providing optimum dynamic line and load regulation response. This feedback system samples the output voltage at the pulse width modulator fixed clock frequency, nominally 550KHz. Multiple converters can be synchronized to a system clock in the 500 KHz to 700KHz range or to the synchronization output of one converter. Undervoltage lockout, primary and secondary referenced inhibit, softstart and load fault protection are provided on all models.

These converters are hermetically packaged in two enclosure variations, utilizing copper core pins to minimize resistive DC losses. Three lead styles are available, each fabricated with International Rectifier's rugged ceramic lead-to-package seal assuring long term hermeticity in the most harsh environments.

Manufactured in a facility fully qualified to MIL-PRF-38534, these converters are fabricated utilizing DSCC qualified processes. For available screening options, refer to device screening table in the data sheet. Variations in electrical, mechanical and screening can be accommodated. Contact IR Santa Clara for special requirements.

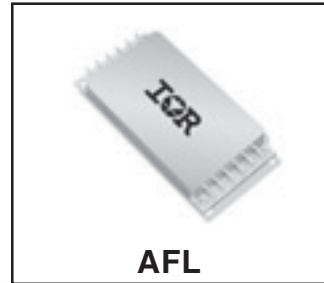

Features

- 160V To 400V Input Range
- 5V, 6V, 9V, 12V, 15V and 28V Outputs Available
- High Power Density - up to 84W/in³
- Up To 120W Output Power
- Parallel Operation with Stress and Current Sharing
- Low Profile (0.380") Seam Welded Package
- Ceramic Feedthru Copper Core Pins
- High Efficiency - to 87%
- Full Military Temperature Range
- Continuous Short Circuit and Overload Protection
- Remote Sensing Terminals
- Primary and Secondary Referenced Inhibit Functions
- Line Rejection > 60dB - DC to 50KHz
- External Synchronization Port
- Fault Tolerant Design
- Dual Output Versions Available
- Standard Microcircuit Drawings Available

Specifications

Absolute Maximum Ratings	
Input voltage	-0.5V to +500VDC
Soldering temperature	300°C for 10 seconds
Operating case temperature	-55°C to +125°C
Storage case temperature	-65°C to +135°C

Static Characteristics $-55^{\circ}\text{C} \leq T_{\text{CASE}} \leq +125^{\circ}\text{C}$, $160 \leq V_{\text{IN}} \leq 400$ unless otherwise specified.

Parameter	Group A Subgroups	Test Conditions	Min	Nom	Max	Unit
INPUT VOLTAGE		Note 6	160	270	400	V
OUTPUT VOLTAGE		$V_{\text{IN}} = 270$ Volts, 100% Load				
AFL27005S	1		4.95	5.00	5.05	V
AFL27006S	1		5.94	6.00	6.06	
AFL27009S	1		8.91	9.00	9.09	
AFL27012S	1		11.88	12.00	12.12	
AFL27015S	1		14.85	15.00	15.15	
AFL27028S	1		27.72	28.00	28.28	
AFL27005S	2, 3		4.90		5.10	
AFL27006S	2, 3		5.88		6.12	
AFL27009S	2, 3		8.82		9.18	
AFL27012S	2, 3		11.76		12.24	
AFL27015S	2, 3		14.70		15.30	
AFL27028S	2, 3		27.44		28.56	
OUTPUT CURRENT		$V_{\text{IN}} = 160, 270, 400$ Volts - Note 6				
AFL27005S					16.0	A
AFL27006S					13.5	
AFL27009S					10.0	
AFL27012S					9.0	
AFL27015S					8.0	
AFL27028S					4.0	
OUTPUT POWER		Note 6				
AFL27005S					80	W
AFL27006S					81	
AFL27009S					90	
AFL27012S					108	
AFL27015S					120	
AFL27028S					112	
MAXIMUM CAPACITIVE LOAD		Note 1	10,000			μF
OUTPUT VOLTAGE TEMPERATURE COEFFICIENT		$V_{\text{IN}} = 270$ Volts, 100% Load - Notes 1, 6	-0.015		+0.015	$\%/^{\circ}\text{C}$
OUTPUT VOLTAGE REGULATION		No Load, 50% Load, 100% Load $V_{\text{IN}} = 160, 270, 400$ Volts				
AFL27028S Line	1, 2, 3		-70.0		+70.0	mV
All Others Line	1, 2, 3		-10.0		+10.0	mV
Load	1, 2, 3		-1.0		+1.0	%
OUTPUT RIPPLE VOLTAGE		$V_{\text{IN}} = 160, 270, 400$ Volts, 100% Load, BW = 10MHz				
AFL27005S	1, 2, 3				30	mVpp
AFL27006S	1, 2, 3				35	
AFL27009S	1, 2, 3				40	
AFL27012S	1, 2, 3				45	
AFL27015S	1, 2, 3				50	
AFL27028S	1, 2, 3				100	

For Notes to Specifications, refer to page 4

Static Characteristics (Continued)

Parameter	Group A Subgroups	Test Conditions	Min	Nom	Max	Unit
INPUT CURRENT No Load Inhibit 1 Inhibit 2	1 2, 3 1, 2, 3 1, 2, 3	$V_{IN} = 270$ Volts $I_{OUT} = 0$ Pin 4 Shorted to Pin 2 Pin 12 Shorted to Pin 8			15.00 17.00 3.00 5.00	mA
INPUT RIPPLE CURRENT AFL27005S AFL27006S AFL27009S AFL27012S AFL27015S AFL27028S	1, 2, 3 1, 2, 3 1, 2, 3 1, 2, 3 1, 2, 3 1, 2, 3	$V_{IN} = 270$ Volts, 100% Load B.W. = 10MHz			60 60 70 70 80 80	mApp
CURRENT LIMIT POINT Expressed as a Percentage of Full Rated Load	1 2 3	$V_{OUT} = 90\% V_{NOM}$ Note 5	115 105 125		125 115 140	%
LOAD FAULT POWER DISSIPATION Overload or Short Circuit	1, 2, 3	$V_{IN} = 270$ Volts			30	W
EFFICIENCY AFL27005S AFL27006S AFL27009S AFL27012S AFL27015S AFL27028S	1, 2, 3 1, 2, 3 1, 2, 3 1, 2, 3 1, 2, 3 1, 2, 3	$V_{IN} = 270$ Volts, 100% Load	78 79 80 82 83 82	82 83 84 85 87 85		%
ENABLE INPUTS (Inhibit Function) Converter Off Sink Current Converter On Sink Current	1, 2, 3 1, 2, 3	Logical Low, Pin 4 or Pin 12 Note 1 Logical High, Pin 4 and Pin 12 - Note 9 Note 1	-0.5 2.0		0.8 100 50 100	V μ A V μ A
SWITCHING FREQUENCY	1, 2, 3		500	550	600	KHz
SYNCHRONIZATION INPUT Frequency Range Pulse Amplitude, Hi Pulse Amplitude, Lo Pulse Rise Time Pulse Duty Cycle	1, 2, 3 1, 2, 3 1, 2, 3	Note 1 Note 1	500 2.0 -0.5 20		700 10 0.8 100 80	KHz V V ns %
ISOLATION	1	Input to Output or Any Pin to Case (except Pin 3). Test @ 500VDC	100			M Ω
DEVICE WEIGHT		Slight Variations with Case Style		85		g
MTBF		MIL-HDBK-217F, AIF @ $T_C = 70^\circ\text{C}$	300			KHrs

For Notes to Specifications, refer to page 4

Dynamic Characteristics $-55^{\circ}\text{C} \leq T_{\text{CASE}} \leq +125^{\circ}\text{C}$, $V_{\text{IN}} = 270$ Volts unless otherwise specified.

Parameter	Group A Subgroups	Test Conditions	Min	Nom	Max	Unit
LOAD TRANSIENT RESPONSE		Note 2, 8				
AFL27005S	Amplitude	Load Step 50% \leftrightarrow 100%	-450		450	mV
	Recovery				200	μs
	Amplitude	Load Step 10% \leftrightarrow 50%	-450		450	mV
	Recovery				400	μs
AFL27006S	Amplitude	Load Step 50% \leftrightarrow 100%	-450		450	mV
	Recovery				200	μs
	Amplitude	Load Step 10% \leftrightarrow 50%	-450		450	mV
	Recovery				400	μs
AFL27009S	Amplitude	Load Step 50% \leftrightarrow 100%	-600		600	mV
	Recovery				200	μs
	Amplitude	Load Step 10% \leftrightarrow 50%	-600		600	mV
	Recovery				400	μs
AFL27012S	Amplitude	Load Step 50% \leftrightarrow 100%	-750		750	mV
	Recovery				200	μs
	Amplitude	Load Step 10% \leftrightarrow 50%	-750		750	mV
	Recovery				400	μs
AFL27015S	Amplitude	Load Step 50% \leftrightarrow 100%	-900		900	mV
	Recovery				200	μs
	Amplitude	Load Step 10% \leftrightarrow 50%	-900		900	mV
	Recovery				400	μs
AFL27028S	Amplitude	Load Step 50% \leftrightarrow 100%	-1200		1200	mV
	Recovery				200	μs
	Amplitude	Load Step 10% \leftrightarrow 50%	-1200		1200	mV
	Recovery				400	μs
LINE TRANSIENT RESPONSE		Note 1, 2, 3				
	Amplitude	V_{IN} Step = 160 \leftrightarrow 400 Volts	-500		500	mV
	Recovery				500	μs
TURN-ON CHARACTERISTICS		$V_{\text{IN}} = 160, 270, 400$ Volts. Note 4				
	Overshoot	Enable 1, 2 on. (Pins 4, 12 high or open)	50	75	250	mV
	Delay				120	ms
LOAD FAULT RECOVERY		Same as Turn On Characteristics.				
LINE REJECTION		MIL-STD-461, CS101, 30Hz to 50KHz Note 1	60	70		dB

Notes to Specifications:

- Parameters not 100% tested but are guaranteed to the limits specified in the table.
- Recovery time is measured from the initiation of the transient to where V_{OUT} has returned to within $\pm 1.0\%$ of V_{OUT} at 50% load.
- Line transient transition time $\geq 100\mu\text{s}$.
- Turn-on delay is measured with an input voltage rise time of between 100V and 500V per millisecond.
- Current limit point is that condition of excess load causing output voltage to drop to 90% of nominal.
- Parameter verified as part of another test.
- All electrical tests are performed with the remote sense leads connected to the output leads at the load.
- Load transient transition time $\geq 10\mu\text{s}$.
- Enable inputs internally pulled high. Nominal open circuit voltage $\approx 4.0\text{VDC}$.

Block Diagram

Figure 1. AFL Single Output

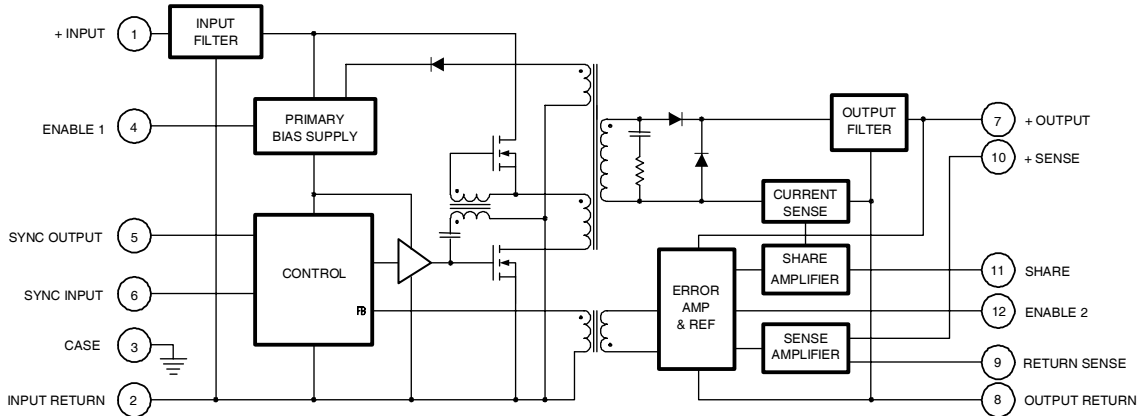

Circuit Operation and Application Information

The AFL series of converters employ a forward switched mode converter topology. (refer to Figure 1.) Operation of the device is initiated when a DC voltage whose magnitude is within the specified input limits is applied between pins 1 and 2. If pin 4 is enabled (at a logical 1 or open) the primary bias supply will begin generating a regulated housekeeping voltage bringing the circuitry on the primary side of the converter to life. Two power MOSFETs used to chop the DC input voltage into a high frequency square wave, apply this chopped voltage to the power transformer. As this switching is initiated, a voltage is impressed on a second winding of the power transformer which is then rectified and applied to the primary bias supply. When this occurs, the input voltage is shut out and the primary bias voltage becomes exclusively internally generated.

The switched voltage impressed on the secondary output transformer winding is rectified and filtered to provide the converter output voltage. An error amplifier on the secondary side compares the output voltage to a precision reference and generates an error signal proportional to the difference. This error signal is magnetically coupled through the feedback transformer into the controller section of the converter varying the pulse width of the square wave signal driving the MOSFETs, narrowing the width if the output voltage is too high and widening it if it is too low.

Remote Sensing

Connection of the + and - sense leads at a remotely located load permits compensation for resistive voltage drop between the converter output and the load when they are physically separated by a significant distance. This connection allows regulation to the placard voltage at the point of application. When the remote sensing features is

not used, the sense leads should be connected to their respective output terminals at the converter. Figure 3. illustrates a typical application.

Inhibiting Converter Output (Enable)

As an alternative to application and removal of the DC voltage to the input, the user can control the converter output by providing TTL compatible, positive logic signals to either of two enable pins (pin 4 or 12). The distinction between these two signal ports is that enable 1 (pin 4) is referenced to the input return (pin 2) while enable 2 (pin 12) is referenced to the output return (pin 8). Thus, the user has access to an inhibit function on either side of the isolation barrier. Each port is internally pulled "high" so that when not used, an open connection on both enable pins permits normal converter operation. When their use is desired, a logical "low" on either port will shut the converter down.

Figure 2. Enable Input Equivalent Circuit

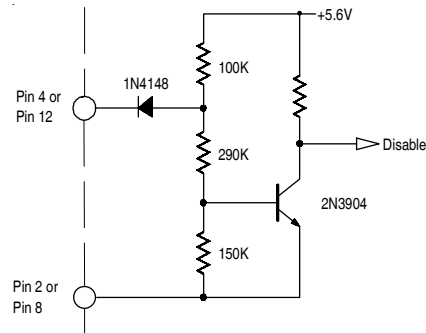

AFL270XXS Series

Internally, these ports differ slightly in their function. In use, a low on Enable 1 completely shuts down all circuits in the converter while a low on Enable 2 shuts down the secondary side while altering the controller duty cycle to near zero. Externally, the use of either port is transparent save for minor differences in idle current. (See specification table).

Synchronization of Multiple Converters

When operating multiple converters, system requirements often dictate operation of the converters at a common frequency. To accommodate this requirement, the AFL series converters provide both a synchronization input and output.

The sync input port permits synchronization of an AFL converter to any compatible external frequency source operating between 500KHz and 700KHz. This input signal should be referenced to the input return and have a 10% to 90% duty cycle. Compatibility requires transition times less than 100ns, maximum low level of +0.8V and a minimum

high level of +2.0V. The sync output of another converter which has been designated as the master oscillator provides a convenient frequency source for this mode of operation. When external synchronization is not required, the sync in pin should be left unconnected thereby permitting the converter to operate at its' own internally set frequency.

The sync output signal is a continuous pulse train set at $550 \pm 50\text{KHz}$, with a duty cycle of $15 \pm 5.0\%$. This signal is referenced to the input return and has been tailored to be compatible with the AFL sync input port. Transition times are less than 100ns and the low level output impedance is less than 50Ω . This signal is active when the DC input voltage is within the specified operating range and the converter is not inhibited. This output has adequate drive reserve to synchronize at least five additional converters. A typical synchronization connection option is illustrated in Figure 3.

Figure 3. Preferred Connection for Parallel Operation

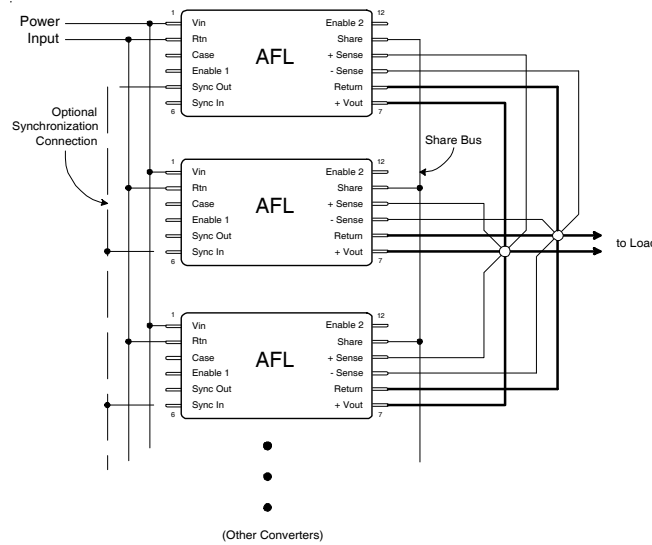

Parallel Operation-Current and Stress Sharing

Figure III. illustrates the preferred connection scheme for operation of a set of AFL converters with outputs operating in parallel. Use of this connection permits equal sharing of a load current exceeding the capacity of an individual AFL among the members of the set. An important feature of the

AFL series operating in the parallel mode is that in addition to sharing the current, the stress induced by temperature will also be shared. Thus if one member of a paralleled set is operating at a higher case temperature, the current it provides to the load will be reduced as compensation for the temperature induced stress on that device.

When operating in the shared mode, it is important that symmetry of connection be maintained as an assurance of optimum load sharing performance. Thus, converter outputs should be connected to the load with equal lengths of wire of the same gauge and sense leads from each converter should be connected to a common physical point, preferably at the load along with the converter output and return leads. All converters in a paralleled set must have their share pins connected together. This arrangement is diagrammatically illustrated in Figure III. showing the outputs and sense pins connected at a star point which is located close as possible to the load.

As a consequence of the topology utilized in the current sharing circuit, the share pin may be used for other functions. In applications requiring a single converter, the voltage appearing on the share pin may be used as a "current monitor". The share pin open circuit voltage is nominally +1.00V at no load and increases linearly with increasing output current to +2.20V at full load. The share pin voltage is referenced to the output return pin.

Thermal Considerations

Because of the incorporation of many innovative technological concepts, the AFL series of converters is capable of providing very high output power from a package of very small volume. These magnitudes of power density can only be obtained by combining high circuit efficiency with effective methods of heat removal from the die junctions. This requirement has been effectively addressed inside the device; but when operating at maximum loads, a significant amount of heat will be generated and this heat must be conducted away from the case. To maintain the case temperature at or below the specified maximum of 125°C, this heat must be transferred by conduction to an appropriate heat dissipater held in intimate contact with the converter base-plate.

Because effectiveness of this heat transfer is dependent on the intimacy of the baseplate/heatsink interface, it is strongly recommended that a high thermal conductivity heat transference medium is inserted between the baseplate and heatsink. The material most frequently utilized at the factory during all testing and burn-in processes is sold under the trade name of Sil-Pad® 400¹. This particular product is an insulator but electrically conductive versions are also available. Use of these materials assures maximum surface contact with the heat dissipator thereby compensating

for minor variations of either surface. While other available types of heat conductive materials and compounds may provide similar performance, these alternatives are often less convenient and are frequently messy to use.

A conservative aid to estimating the total heat sink surface area ($A_{HEAT\ SINK}$) required to set the maximum case temperature rise (ΔT) above ambient temperature is given by the following expression:

$$A_{HEAT\ SINK} \approx \left\{ \frac{\Delta T}{80P^{0.85}} \right\}^{-1.43} - 3.0$$

where

ΔT = Case temperature rise above ambient

$$P = \text{Device dissipation in Watts} = P_{OUT} \left\{ \frac{1}{Eff} - 1 \right\}$$

As an example, it is desired to maintain the case temperature of an AFL27015S at $\leq +85^\circ\text{C}$ in an area where the ambient temperature is held at a constant $+25^\circ\text{C}$; then

$$\Delta T = 85 - 25 = 60^\circ\text{C}$$

From the Specification Table, the worst case full load efficiency for this device is 83%; therefore the power dissipation at full load is given by

$$P = 120 \cdot \left\{ \frac{1}{.83} - 1 \right\} = 120 \cdot (0.205) = 24.6\text{W}$$

and the required heat sink area is

$$A_{HEAT\ SINK} = \left\{ \frac{60}{80 \cdot 24.6^{0.85}} \right\}^{-1.43} - 3.0 = 71\text{ in}^2$$

Thus, a total heat sink surface area (including fins, if any) of 71 in² in this example, would limit case rise to 60°C above ambient. A flat aluminum plate, 0.25" thick and of approximate dimension 4" by 9" (36 in² per side) would suffice for this application in a still air environment. Note that to meet the criteria in this example, both sides of the plate require unrestricted exposure to the ambient air.

¹Sil-Pad is a registered Trade Mark of Bergquist, Minneapolis, MN

Input Filter

The AFL270XXS series converters incorporate a single stage LC input filter whose elements dominate the input load impedance characteristic during the turn-on sequence. The input circuit is as shown in Figure 4.

Figure 4. Input Filter Circuit

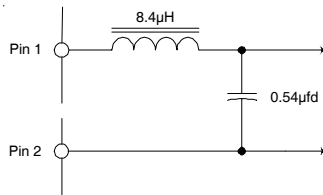

Undervoltage Lockout

A minimum voltage is required at the input of the converter to initiate operation. This voltage is set to 150V ± 5.0V. To preclude the possibility of noise or other variations at the input falsely initiating and halting converter operation, a hysteresis of approximately 10V is incorporated in this circuit. Thus if the input voltage droops to 140V ± 5.0V, the converter will shut down and remain inoperative until the input voltage returns to ≈ 150V.

Output Voltage Adjust

In addition to permitting close voltage regulation of remotely located loads, it is possible to utilize the converter sense pins to incrementally increase the output voltage over a limited range. The adjustments made possible by this method are intended as a means to “trim” the output to a voltage setting for some particular application, but are not intended to create an adjustable output converter. These output voltage setting variations are obtained by connecting an appropriate resistor value between the +sense and -sense pins while connecting the -sense pin to the output return pin as shown in Figure 5. below. The range of adjustment and corresponding range of resistance values can be determined by use of the equation presented below.

$$R_{adj} = 100 \bullet \left\{ \frac{V_{NOM}}{V_{OUT} - V_{NOM} - .025} \right\}$$

Where V_{NOM} = device nominal output voltage, and
 V_{OUT} = desired output voltage

Finding a resistor value for a particular output voltage, is simply a matter of substituting the desired output voltage and the nominal device voltage into the equation and solving for the corresponding resistor value.

Figure 5. Connection for V_{OUT} Adjustment

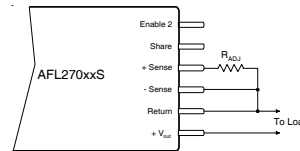

Caution: Do not set $R_{adj} < 500\Omega$

Attempts to adjust the output voltage to a value greater than 120% of nominal should be avoided because of the potential of exceeding internal component stress ratings and subsequent operation to failure. Under no circumstance should the external setting resistor be made less than 500Ω. By remaining within this specified range of values, completely safe operation fully within normal component derating is assured.

Examination of the equation relating output voltage and resistor value reveals a special benefit of the circuit topology utilized for remote sensing of output voltage in the AFL270XXS series of converters. It is apparent that as the resistance increases, the output voltage approaches the nominal set value of the device. In fact the calculated limiting value of output voltage as the adjusting resistor becomes very large is ≈ 25mV above nominal device voltage.

The consequence is that if the +sense connection is unintentionally broken, an AFL270XXS has a fail-safe output voltage of $V_{out} + 25mV$, where the 25mV is independent of the nominal output voltage. It can be further demonstrated that in the event of both the + and - sense connections being broken, the output will be limited to $V_{out} + 440mV$. This 440mV is also essentially constant independent of the nominal output voltage. While operation in this condition is not damaging to the device, not all performance parameters will be met.

Performance Data

Typical performance data is graphically presented on the following pages for selected parameters on a variety of AFL270XXS type converters. The data presented was selected as representative of more critical parameters and for general interest in typical converter applications.

AFL270XXS - Typical Line Rejection Characteristics

Measured per MIL-STD 461D, CS101 with 100% Output Load, $V_{in} = 270VDC$

Fig.6 AFL27005S

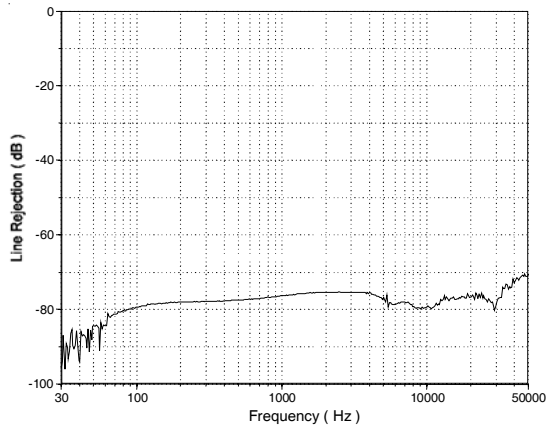

Fig.7 AFL27006S

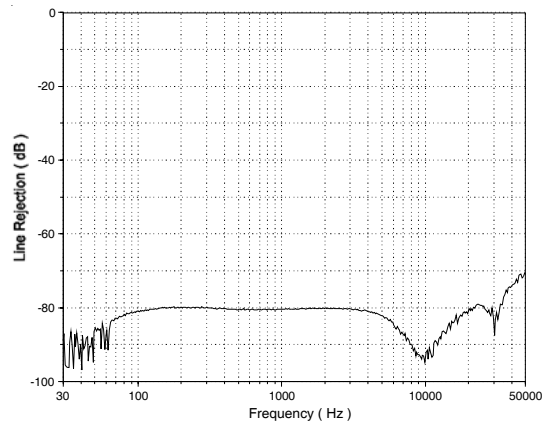

Fig.8 AFL27009S

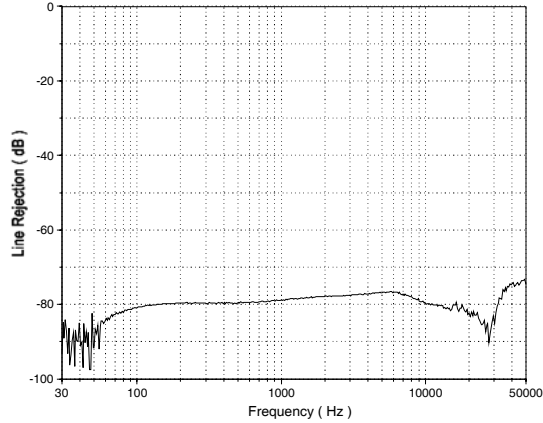

Fig.9 AFL27012S

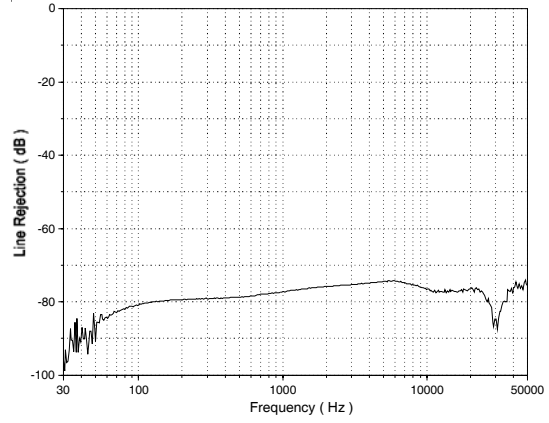

Fig.10 AFL27015S

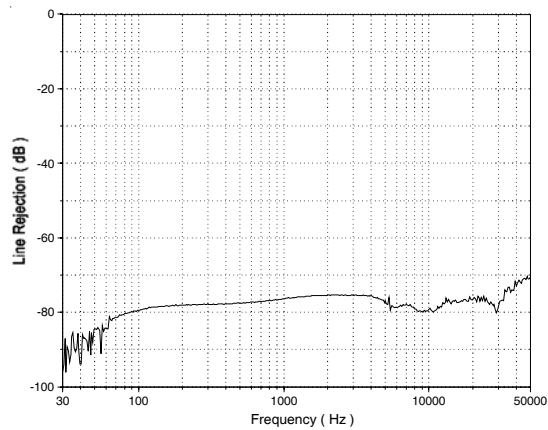
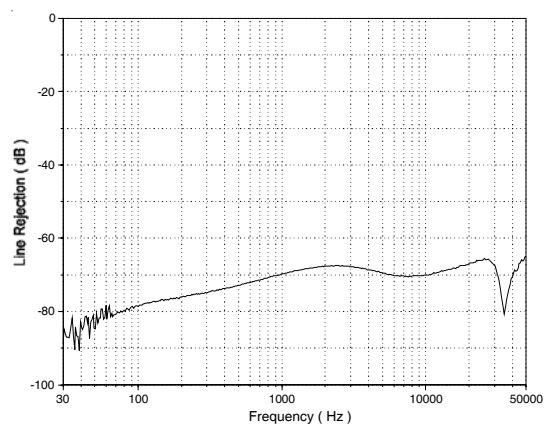

Fig.11 AFL27028S



AFL270XXS Series

International
IRF Rectifier

AFL270XXS Typical Efficiency Characteristics

Presented for three values of Input Voltage.

Fig.12 AFL27005S

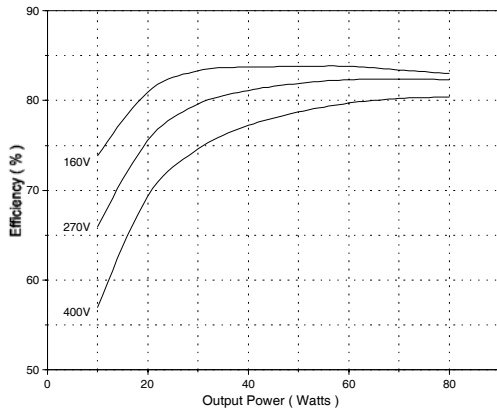

Fig.13 AFL27006S

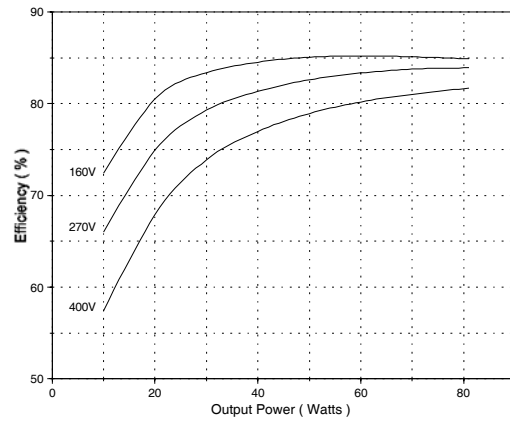

Fig.14 AFL27009S

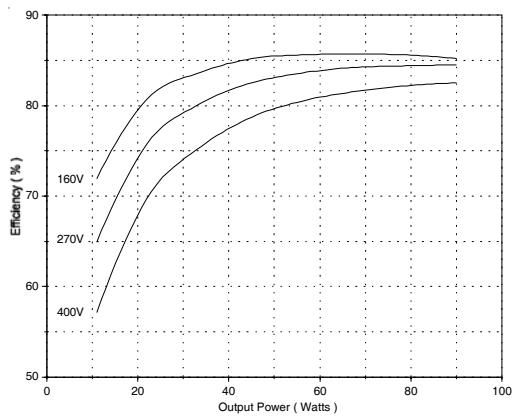

Fig.15 AFL27012S

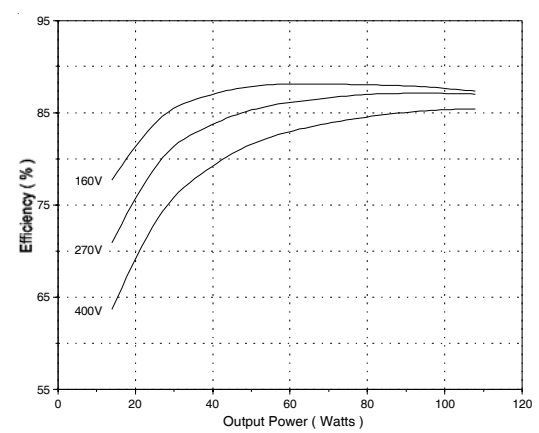

Fig.16 AFL27015S

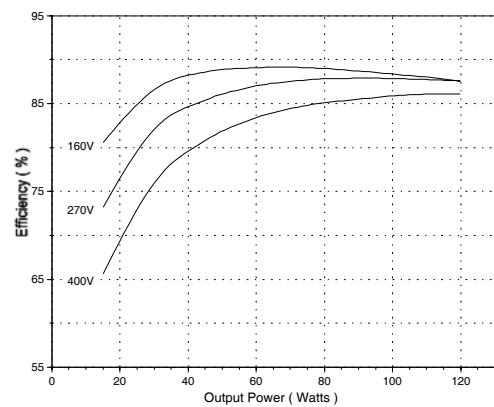
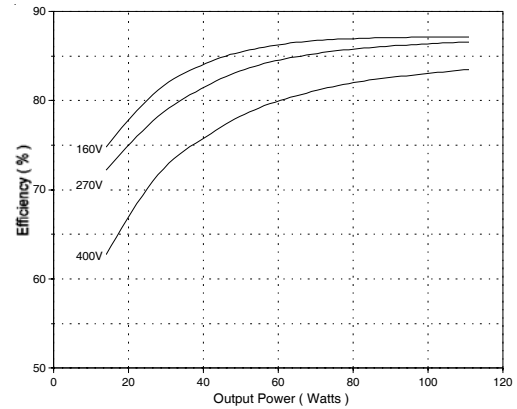

Fig.17 AFL27028S



Typical Performance Characteristics - AFL27005S

Output Load = 100%, Vin = 270VDC unless otherwise specified.

Fig.18 Turn-on Time, No Load

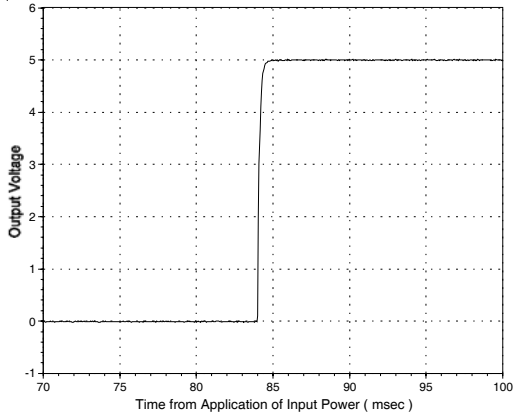

Fig.19 Turn-on Time, Full Load

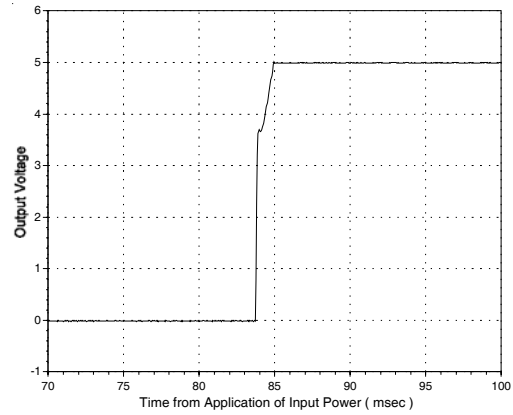

Fig.20 Output Ripple Voltage

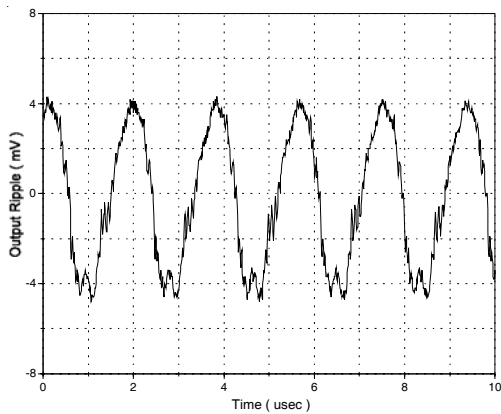

Fig.21 Input Ripple Current

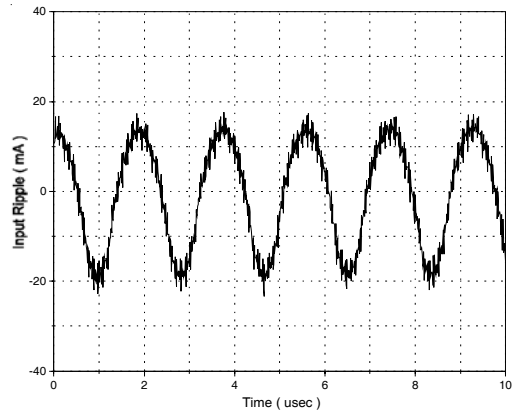

Fig.22 Output Load Transient Response
 50% Load to/from 100% Load

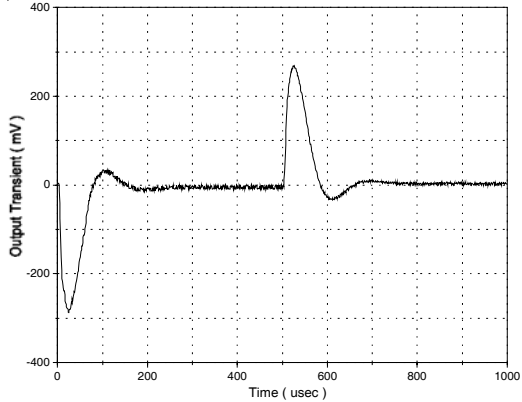
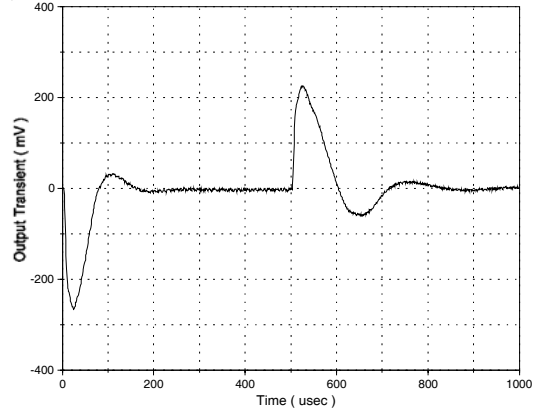

Fig.23 Output Load Transient Response
 10% Load to/from 50% Load



Typical Performance Characteristics - AFL27015S

Output Load = 100%, V_{in} = 270VDC unless otherwise specified.

Fig.24 Turn-on Time, No Load

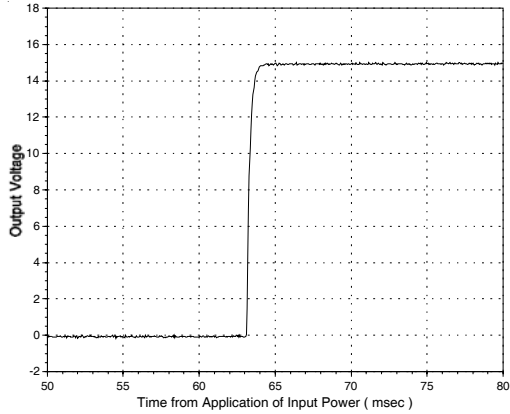

Fig.25 Turn-on Time, Full Load

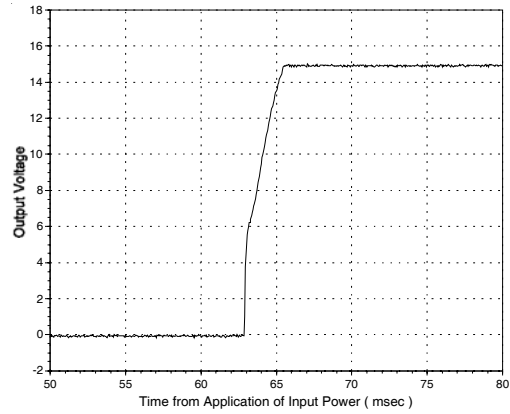

Fig.26 Output Ripple Voltage

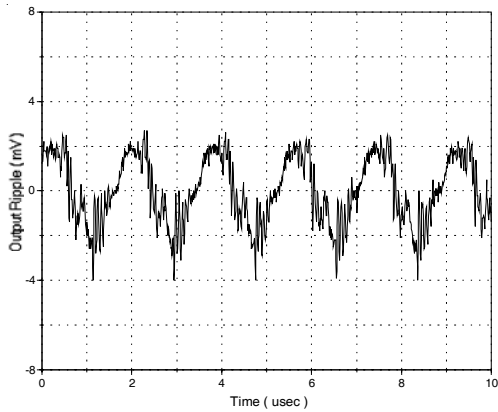

Fig.27 Input Ripple Current

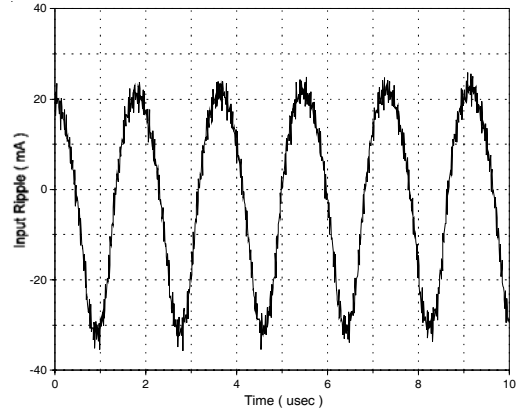

Fig.28 Output Load Transient Response
50% Load to/from 100% Load

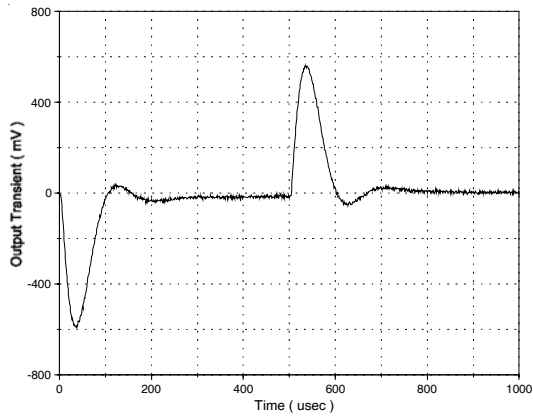
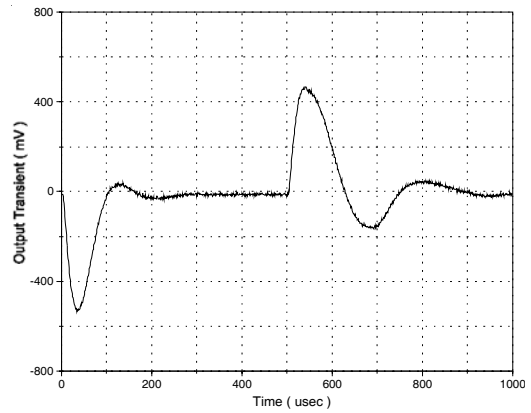

Fig.29 Output Load Transient Response
10% Load to/from 50% Load



Typical Performance Characteristics - AFL27028S

Output Load = 100%, Vin = 270VDC unless otherwise specified.

Fig.30 Turn-on Time, No Load

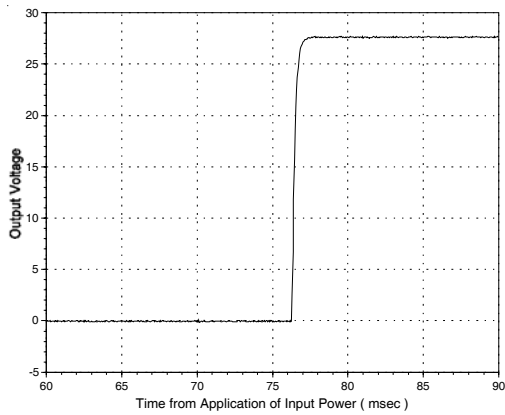

Fig.31 Turn-on Time, Full Load

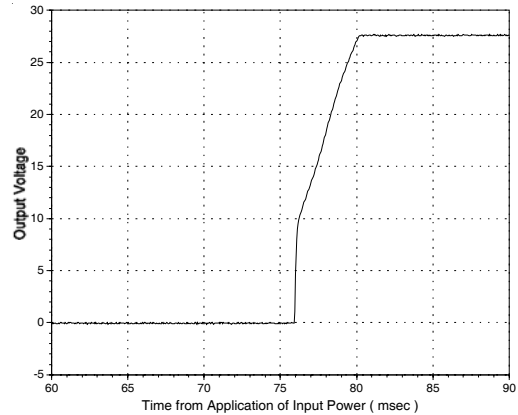

Fig.32 Output Ripple Voltage

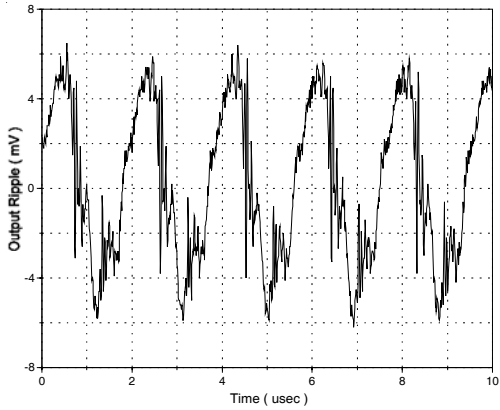

Fig.33 Input Ripple Current

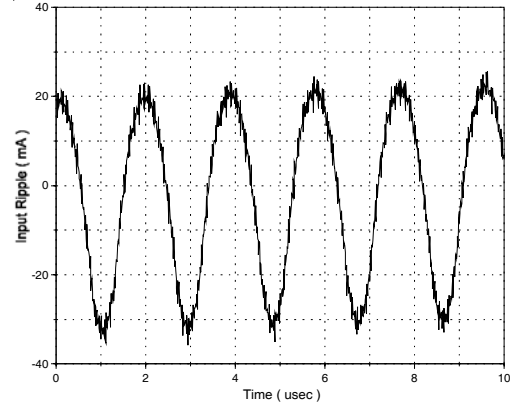

Fig.34 Output Load Transient Response
50% Load to/from 100% Load

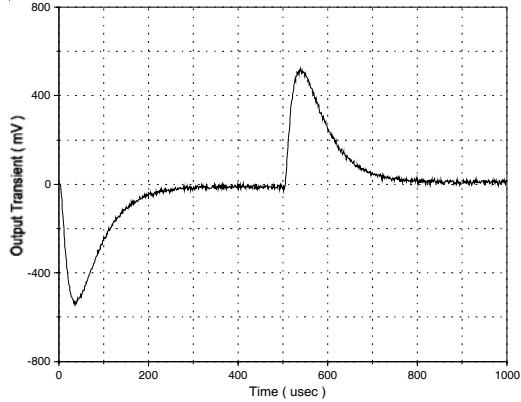
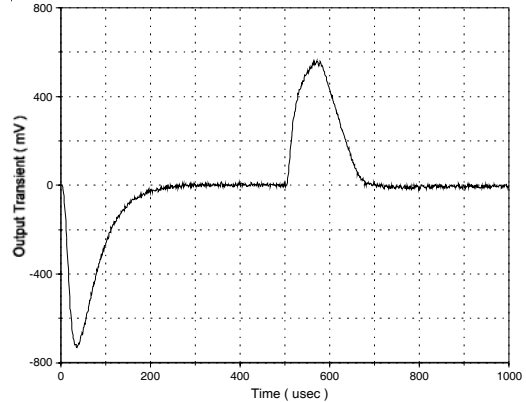
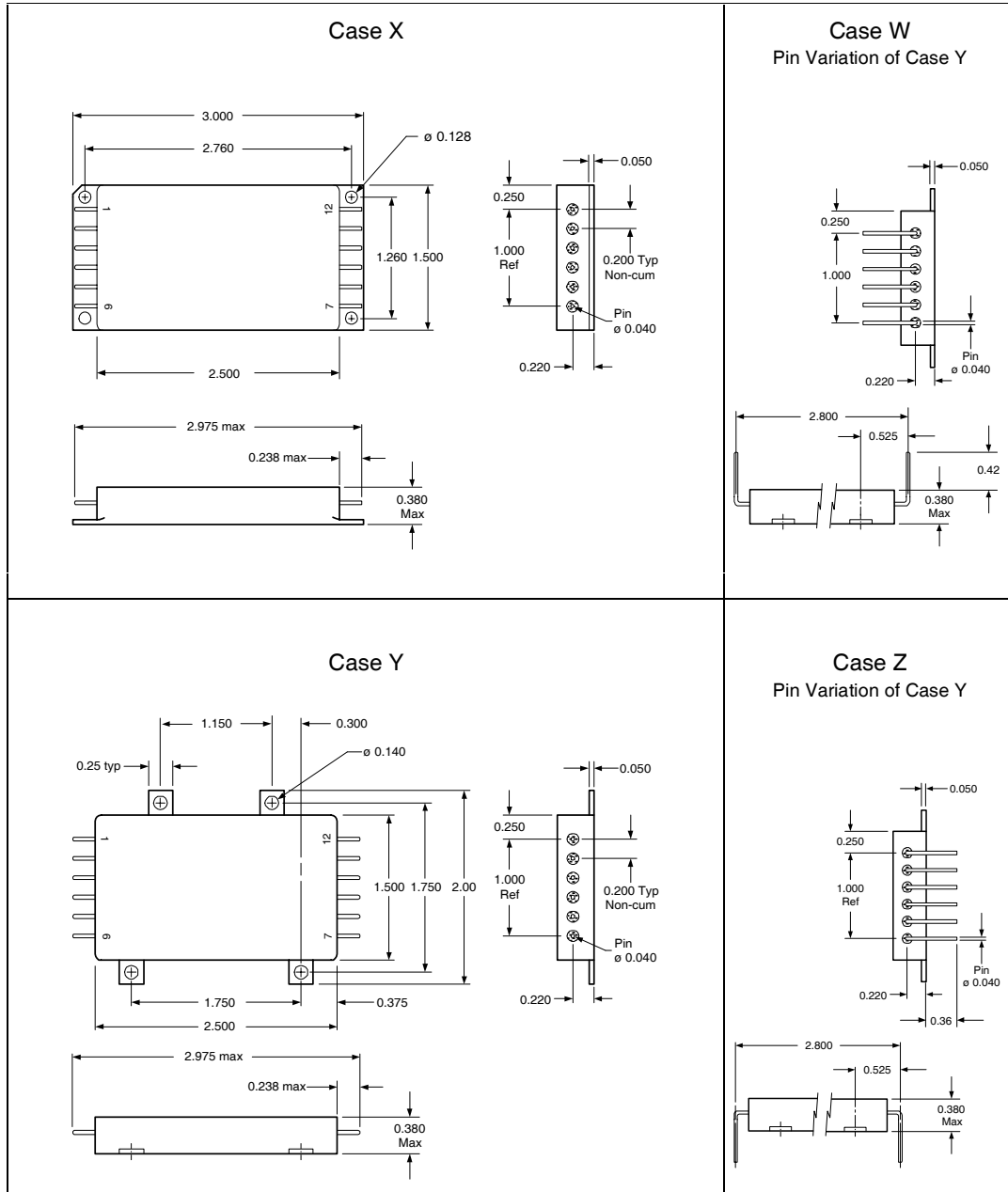

Fig.35 Output Load Transient Response
10% Load to/from 50% Load



Mechanical Outlines



Tolerances, unless otherwise specified: .XX = ± 0.010

.XXX = ± 0.005

BERYLLIA WARNING: These converters are hermetically sealed; however they contain BeO substrates and should not be ground or subjected to any other operations including exposure to acids, which may produce Beryllium dust or fumes containing Beryllium

Pin Designation

Pin #	Designation
1	+ Input
2	Input Return
3	Case Ground
4	Enable 1
5	Sync Output
6	Sync Input
7	+ Output
8	Output Return
9	Return Sense
10	+ Sense
11	Share
12	Enable 2

Standard Microcircuit Drawing Equivalence Table

Standard Microcircuit Drawing Number	IR Standard Part Number
5962-94569	AFL27005S
5962-95534	AFL27006S
5962-95535	AFL27009S
5962-94753	AFL27012S
5962-94570	AFL27015S
5962-95565	AFL27028S

Device Screening

Requirement	MIL-STD-883 Method	No Suffix	ES ②	HB	CH
Temperature Range	—	-20°C to +85°C	-55°C to +125°C ③	-55°C to +125°C	-55°C to +125°C
Element Evaluation	MIL-PRF-38534	N/A	N/A	N/A	Class H
Non-Destructive Bond Pull	2023	N/A	N/A	N/A	N/A
Internal Visual	2017	①	Yes	Yes	Yes
Temperature Cycle	1010	N/A	Cond B	Cond C	Cond C
Constant Acceleration	2001, Y1 Axis	N/A	500 Gs	3000 Gs	3000 Gs
PIND	2020	N/A	N/A	N/A	N/A
Burn-In	1015	N/A	48 hrs@hi temp	160 hrs@125°C	160 hrs@125°C
Final Electrical (Group A)	MIL-PRF-38534 & Specification	25°C	25°C ②	-55°C, +25°C, +125°C	-55°C, +25°C, +125°C
PDA	MIL-PRF-38534	N/A	N/A	N/A	10%
Seal, Fine and Gross	1014	Cond A	Cond A, C	Cond A, C	Cond A, C
Radiographic	2012	N/A	N/A	N/A	N/A
External Visual	2009	①	Yes	Yes	Yes

Notes:

- ① Best commercial practice
- ② Sample tests at low and high temperatures
- ③ -55°C to +105°C for AHE, ATO, ATW

Part Numbering

