

STANDARD RECOVERY DIODES

Hockey Puk Version

Features

- Wide current range
- High voltage ratings up to 600V
- High surge current capabilities
- Diffused junction
- Hockey Puk version
- Case style B-44 (R-PUK)

Typical Applications

- Converters
- Power supplies
- High power drives
- Auxiliary system supplies for traction applications

9570A

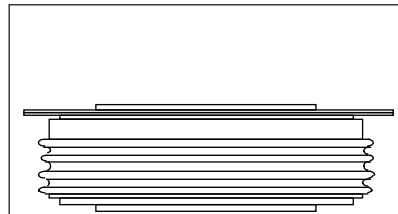

case style B-44 (R-PUK)

Major Ratings and Characteristics

Parameters	SD8500C..R	Units	
$I_{F(AV)}$	9570	A	
@ T_{hs}	55	°C	
$I_{F(RMS)}$	15350	A	
@ T_{hs}	25	°C	
I_{FSM}	@ 50Hz	95500	A
	@ 60Hz	100000	A
I^2t	@ 50Hz	45620	KA ² s
	@ 60Hz	41640	KA ² s
V_{RRM} range	200 to 600	V	
T_J	- 40 to 200	°C	

ELECTRICAL SPECIFICATIONS

Voltage Ratings

Type number	Voltage Code	V_{RRM} : maximum repetitive peak reverse voltage V	V_{RSM} : maximum non-repetitive peak rev. voltage V	I_{RRM} max. @ $T_J = 200^\circ\text{C}$ mA
SD8500C..R	02	200	300	200
	04	400	500	
	06	600	700	

Forward Conduction

Parameter	SD8500C..R	Units	Conditions
$I_{F(AV)}$ Max. average forward current @ Heatsink temperature	9570 (5150)	A	180° conduction, half sine wave
	55 (85)	°C	Double side (single side) cooled
$I_{F(RMS)}$ Max. RMS forward current	15350	A	@ 25°C heatsink temperature double side cooled
I_{FSM} Max. peak, one-cycle forward, non-repetitive surge current	95500	A	t = 10ms No voltage reappplied
	100000		t = 8.3ms reappplied
	80300		t = 10ms 100% V_{RRM} reappplied
	84100		t = 8.3ms reappplied
I^2t Maximum I^2t for fusing	45620	KA ² s	t = 10ms No voltage reappplied
	41640		t = 8.3ms reappplied
	32260		t = 10ms 100% V_{RRM} reappplied
	29450		t = 8.3ms reappplied
$I^2\sqrt{t}$ Maximum $I^2\sqrt{t}$ for fusing	456200	KA ² √s	t = 0.1 to 10ms, no voltage reappplied
$V_{F(TO)1}$ Low level value of threshold voltage	0.670	V	$(16.7\% \times \pi \times I_{F(AV)} < I < \pi \times I_{F(AV)})$, $T_J = T_J$ max.
$V_{F(TO)2}$ High level value of threshold voltage	0.721		$(I > \pi \times I_{F(AV)})$, $T_J = T_J$ max.
r_{f1} Low level value of forward slope resistance	0.030	mΩ	$(16.7\% \times \pi \times I_{F(AV)} < I < \pi \times I_{F(AV)})$, $T_J = T_J$ max.
r_{f2} High level value of forward slope resistance	0.028		$(I > \pi \times I_{F(AV)})$, $T_J = T_J$ max.
V_{FM} Max. forward voltage drop	0.97	V	$I_{pk} = 10000A$, $T_J = T_J$ max, $t_p = 10ms$ sinus. wave

Thermal and Mechanical Specifications

Parameter	SD8500C..R	Units	Conditions
T _J Max. junction operating temperature range	-40 to 200	°C	
T _{stg} Max. storage temperature range	-55 to 200		
R _{thJ-hs} Max. thermal resistance, junction to heatsink	0.02 0.01	K/W	DC operation single side cooled DC operation double side cooled
F Mounting force, ± 10%	39200 (4000)	N (Kg)	
wt Approximate weight	1590	g	
Case style	B-44 (R-PUK)		See Outline Table

ΔR_{thJ-hs} Conduction

(The following table shows the increment of thermal resistance R_{thJ-hs} when devices operate at different conduction angles than DC)

Conduction angle	Sinusoidal conduction		Rectangular conduction		Units	Conditions
	Single Side	Double Side	Single Side	Double Side		
180°	0.0009	0.0010	0.0006	0.0006	K/W	T _J = T _J max.
120°	0.0010	0.0011	0.0010	0.0010		
90°	0.0013	0.0013	0.0014	0.0014		
60°	0.0019	0.0019	0.0020	0.0020		
30°	0.0033	0.0033	0.0034	0.0034		

Ordering Information Table

Device Code

SD	850	0	C	06	R
①	②	③	④	⑤	⑥

- 1** - Diode
- 2** - Essential part number
- 3** - 0 = Standard recovery
- 4** - C = Ceramic Puk
- 5** - Voltage code: code x 100 = V_{RRM} (see Voltage Ratings Table)
- 6** - R = Puk Case B-44 (R-PUK)

SD8500C..R Series

Bulletin I2036 rev. A 04/00

International
IRF Rectifier

Outline Table

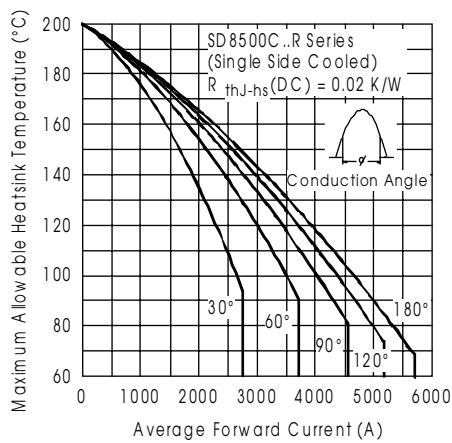
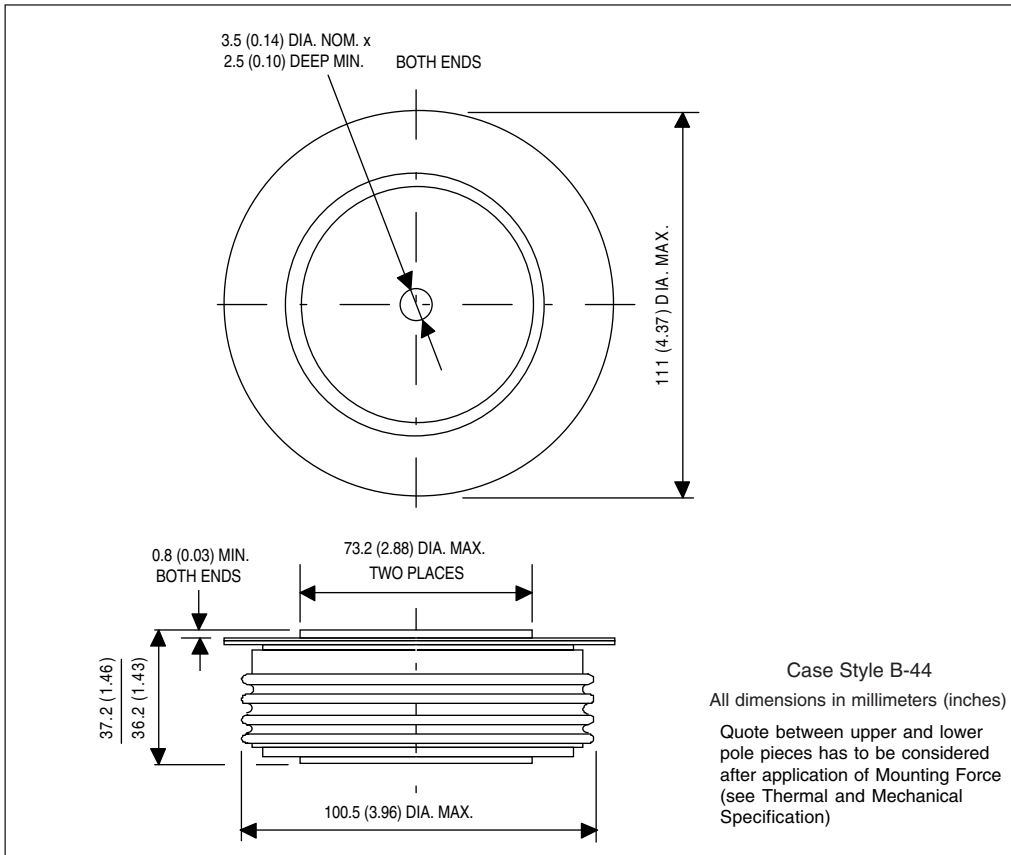

Fig. 1 - Current Ratings Characteristics

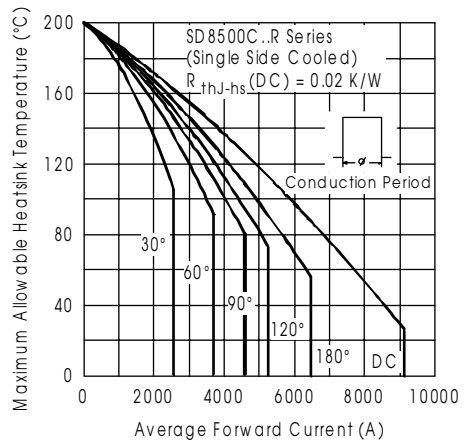

Fig. 2 - Current Ratings Characteristics

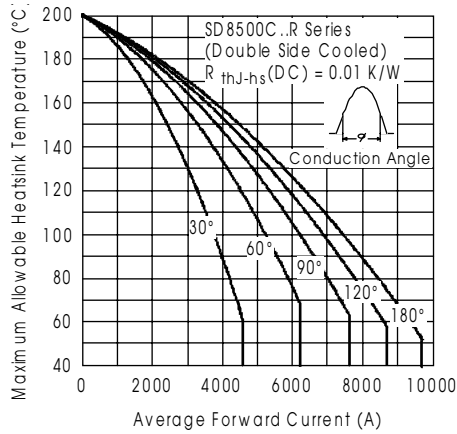

Fig. 3 - Current Ratings Characteristics

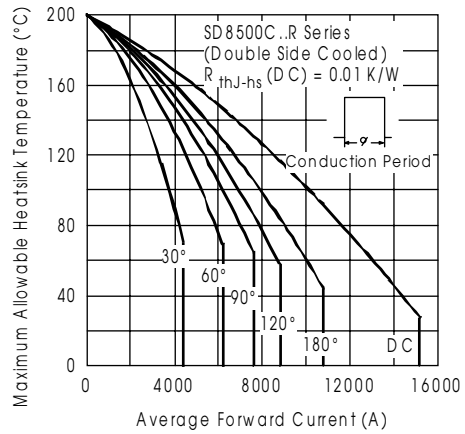

Fig. 4 - Current Ratings Characteristics

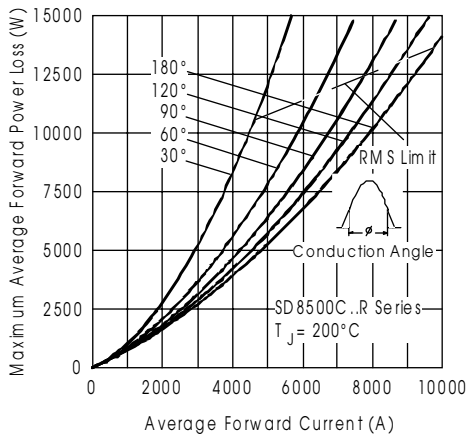

Fig. 5 - Forward Power Loss Characteristics

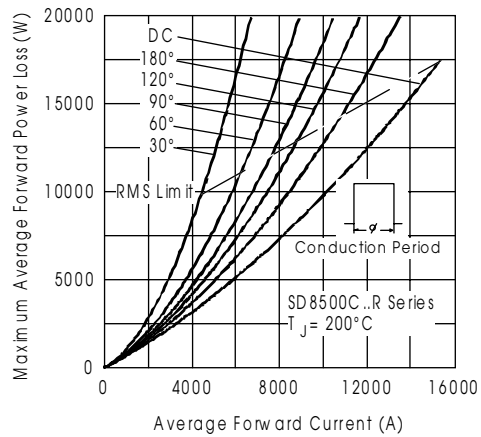

Fig. 6 - Forward Power Loss Characteristics

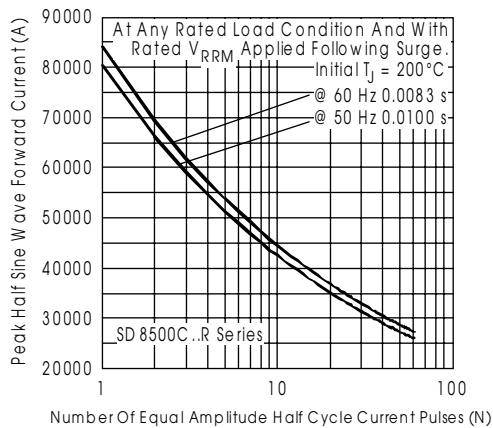

Fig. 7 - Maximum Non-Repetitive Surge Current Single and Double Side Cooled

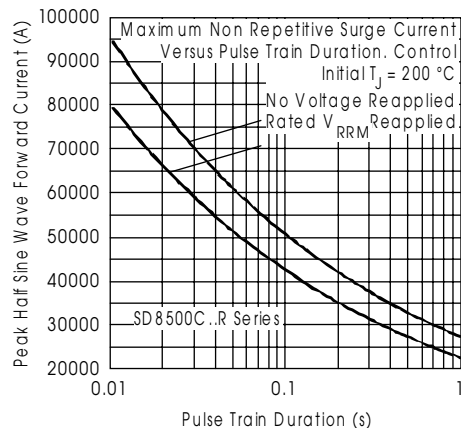

Fig. 8 - Maximum Non-Repetitive Surge Current Single and Double Side Cooled

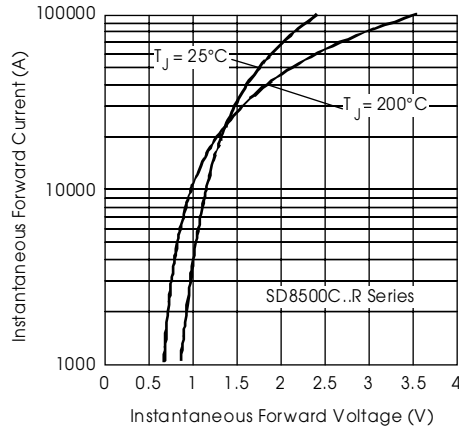

Fig. 9 - Forward Voltage Drop Characteristics

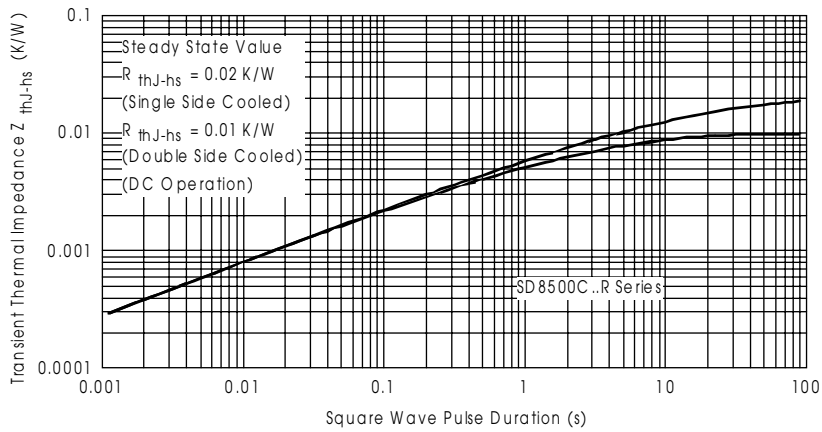

Fig. 10 - Thermal Impedance Z_{thJ-hs} Characteristics