

STANDARD RECOVERY DIODES

Hockey Puk Version

Features

- Wide current range
- High voltage ratings up to 1000V
- High surge current capabilities
- Diffused junction
- Hockey Puk version
- Case style DO-200AC (K-PUK)

Typical Applications

- Converters
- Power supplies
- High power drives
- Auxiliary system supplies for traction applications

3800A

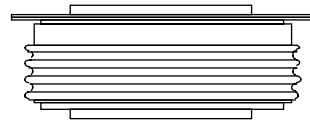

case style DO-200AC (K-PUK)

Major Ratings and Characteristics

Parameters	SD3000C..K	Units	
$I_{F(AV)}$	3800	A	
@ T_{hs}	55	°C	
$I_{F(RMS)}$	6230	A	
@ T_{hs}	25	°C	
I_{FSM}	@ 50Hz	35800	A
	@ 60Hz	37500	A
I^2t	@ 50Hz	6410	KA ² s
	@ 60Hz	5850	KA ² s
V_{RRM} range	400 to 1000	V	
T_J	- 40 to 180	°C	

SD3000C..K Series

Bulletin I2090 rev.C 04/00

International
IRF Rectifier

ELECTRICAL SPECIFICATIONS

Voltage Ratings

Type number	Voltage Code	V_{RRM} : maximum repetitive peak reverse voltage V	V_{RSM} : maximum non-repetitive peak rev. voltage V	I_{RRM} max. @ $T_J = 180^\circ\text{C}$ mA
SD3000C..K	04	400	500	75
	08	800	900	
	10	1000	1100	

Forward Conduction

Parameter	SD3000C..K	Units	Conditions
$I_{F(AV)}$ Max. average forward current @ Heatsink temperature	3800 (1925)	A	180° conduction, half sine wave
	55 (85)	°C	Double side (single side) cooled
$I_{F(RMS)}$ Max. RMS forward current	6230	A	@ 25°C heatsink temperature double side cooled
I_{FSM} Max. peak, one-cycle forward, non-repetitive surge current	35800	A	t = 10ms No voltage reappplied
	37500		t = 8.3ms reappplied
	30100		t = 10ms 100% V_{RRM} reappplied
	31500		t = 8.3ms reappplied
I^2t Maximum I^2t for fusing	6410	KA ² s	t = 10ms No voltage reappplied
	5850		t = 8.3ms reappplied
	4530		t = 10ms 100% V_{RRM} reappplied
	4135		t = 8.3ms reappplied
$I^2\sqrt{t}$ Maximum $I^2\sqrt{t}$ for fusing	64100	KA ² √s	t = 0.1 to 10ms, no voltage reappplied
$V_{F(TO)1}$ Low level value of threshold voltage	0.74	V	$(16.7\% \times \pi \times I_{F(AV)} < I < \pi \times I_{F(AV)})$, $T_J = T_J \text{ max.}$
$V_{F(TO)2}$ High level value of threshold voltage	0.86		$(I > \pi \times I_{F(AV)})$, $T_J = T_J \text{ max.}$
r_{f1} Low level value of forward slope resistance	0.08	mΩ	$(16.7\% \times \pi \times I_{F(AV)} < I < \pi \times I_{F(AV)})$, $T_J = T_J \text{ max.}$
r_{f2} High level value of forward slope resistance	0.07		$(I > \pi \times I_{F(AV)})$, $T_J = T_J \text{ max.}$
V_{FM} Max. forward voltage drop	1.22	V	$I_{pk} = 6000\text{A}$, $T_J = T_J \text{ max.}$, $t_p = 10\text{ms}$ sinusoidal wave

Thermal and Mechanical Specifications

Parameter	SD3000C..K	Units	Conditions
T _J Max. junction operating temperature range	-40 to 180	°C	
T _{stg} Max. storage temperature range	-55 to 200		
R _{thJ-hs} Max. thermal resistance, junction to heatsink	0.042 0.020	K/W	DC operation single side cooled DC operation double side cooled
F Mounting force, ± 10%	22250 (2250)	N (Kg)	
wt Approximate weight	425	g	
Case style	DO-200AC(K-PUK)		See Outline Table

ΔR_{thJ-hs} Conduction

(The following table shows the increment of thermal resistance R_{thJ-hs} when devices operate at different conduction angles than DC)

Conduction angle	Sinusoidal conduction		Rectangular conduction		Units	Conditions
	Single Side	Double Side	Single Side	Double Side		
180°	0.002	0.002	0.001	0.001	K/W	T _J = T _J max.
120°	0.002	0.002	0.002	0.002		
90°	0.003	0.003	0.003	0.003		
60°	0.004	0.004	0.004	0.004		
30°	0.007	0.007	0.007	0.007		

Ordering Information Table

Device Code

SD	300	0	C	10	K
①	②	③	④	⑤	⑥

- 1** - Diode
- 2** - Essential part number
- 3** - 0 = Standard recovery
- 4** - C = Ceramic Puk
- 5** - Voltage code: code x 100 = V_{RRM} (see Voltage Ratings Table)
- 6** - K = Puk Case DO-200AC (K-PUK)

SD3000C..K Series

Bulletin I2090 rev. C 04/00

International
IRF Rectifier

Outline Table

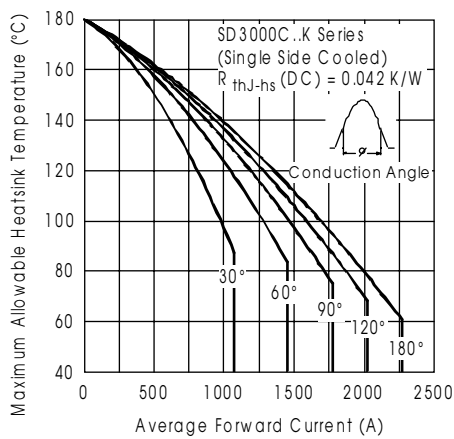
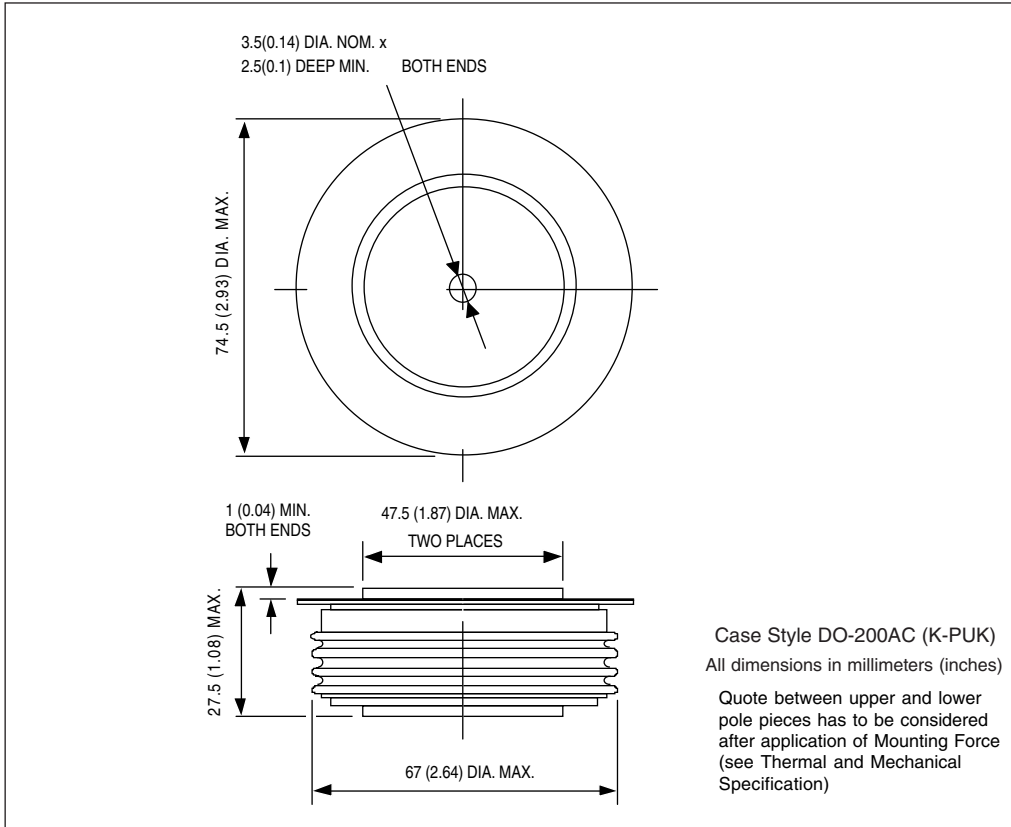

Fig. 1 - Current Ratings Characteristics

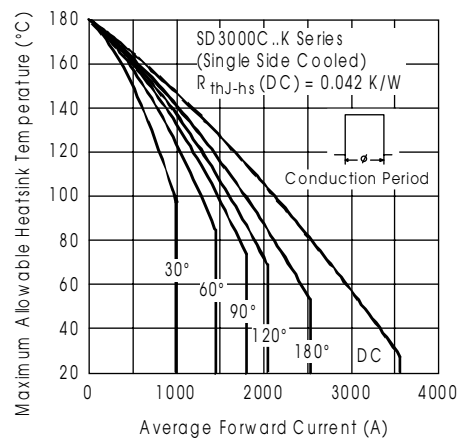

Fig. 2 - Current Ratings Characteristics

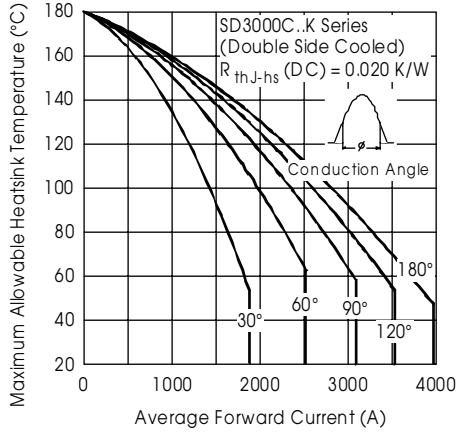

Fig. 3 - Current Ratings Characteristics

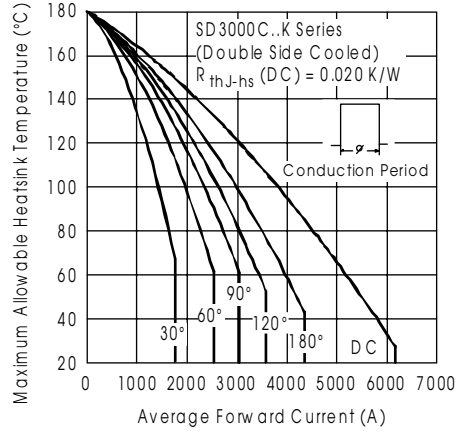

Fig. 4 - Current Ratings Characteristics

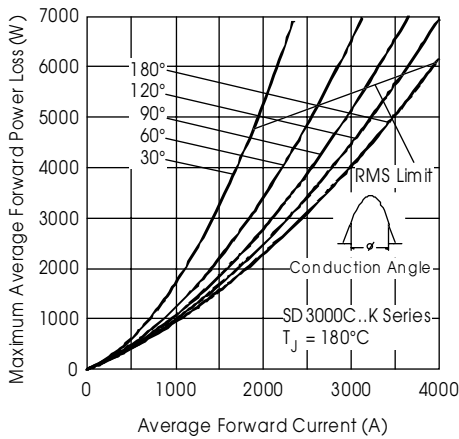

Fig. 5 - Forward Power Loss Characteristics

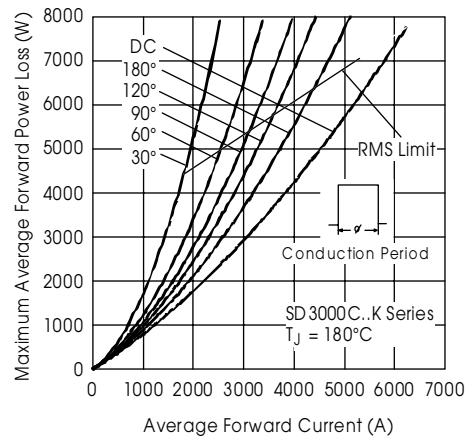

Fig. 6 - Forward Power Loss Characteristics

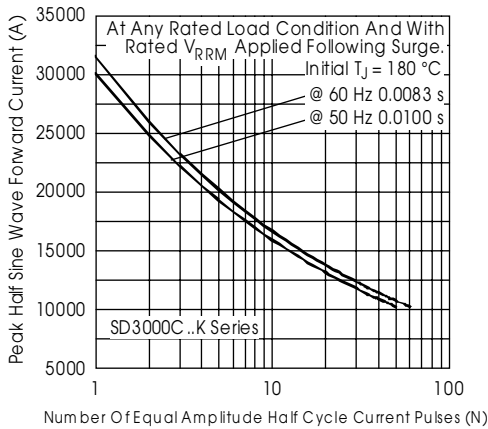

Fig. 7 - Maximum Non-Repetitive Surge Current Single and Double Side Cooled

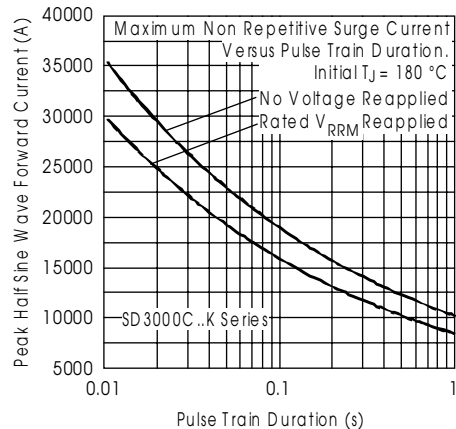

Fig. 8 - Maximum Non-Repetitive Surge Current Single and Double Side Cooled

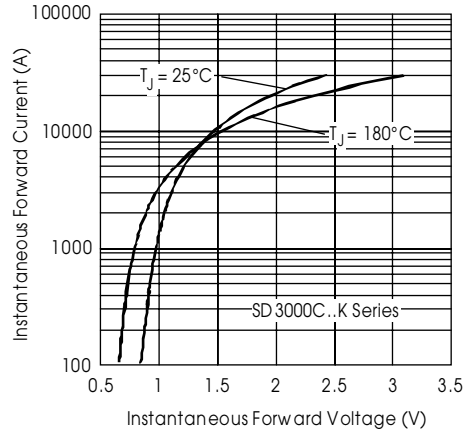

Fig. 9 - Forward Voltage Drop Characteristics

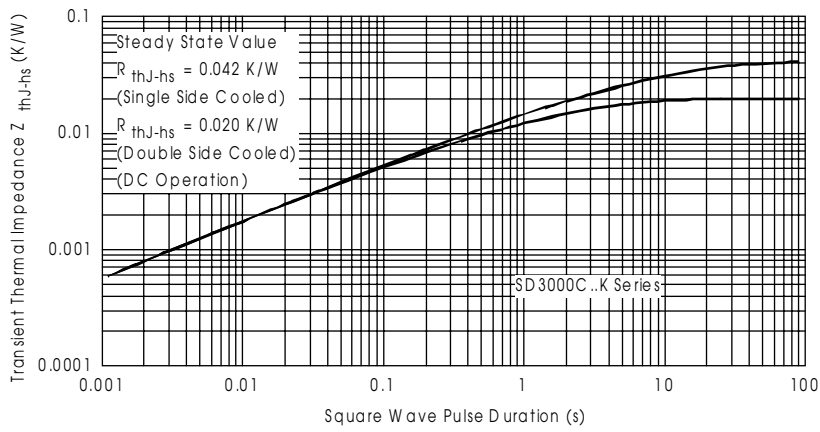

Fig. 10 - Thermal Impedance Z_{thJ-hs} Characteristics