

IRLI3215PbF

HEXFET® Power MOSFET

- Advanced Process Technology
- Ultra Low On-Resistance
- Dynamic dv/dt Rating
- 175°C Operating Temperature
- Fast Switching
- Fully Avalanche Rated
- Lead-Free

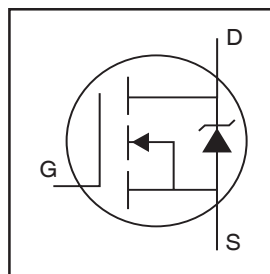

$V_{DSS} = 150V$
$R_{DS(on)} = 0.166 \Omega$
$I_D = 12A \text{⑤}$

Description

Fifth Generation HEXFETs from International Rectifier utilize advanced processing techniques to achieve extremely low on-resistance per silicon area. This benefit, combined with the fast switching speed and ruggedized device design that HEXFET Power MOSFETs are well known for, provides the designer with an extremely efficient and reliable device for use in a wide variety of applications.

The TO-220 Fullpak eliminates the need for additional insulating hardware in commercial-industrial applications. The moulding compound used provides a high isolation capability and a low thermal resistance between the tab and external heatsink. This isolation is equivalent to using a 100 micron mica barrier with standard TO-220 product. The Fullpak is mounted to a heatsink using a single clip or by a single screw fixing.

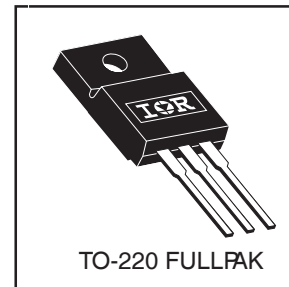

Absolute Maximum Ratings

	Parameter	Max.	Units
$I_D @ T_C = 25^\circ C$	Continuous Drain Current, $V_{GS} @ 10V$	12 ⑤	A
$I_D @ T_C = 100^\circ C$	Continuous Drain Current, $V_{GS} @ 10V$	8.5	
I_{DM}	Pulsed Drain Current ①⑥	48	
$P_D @ T_C = 25^\circ C$	Power Dissipation	80	W
	Linear Derating Factor	0.53	W/°C
V_{GS}	Gate-to-Source Voltage	± 16	V
E_{AS}	Single Pulse Avalanche Energy②⑥	130	mJ
I_{AR}	Avalanche Current①⑥	7.2	A
E_{AR}	Repetitive Avalanche Energy①	8.0	mJ
dv/dt	Peak Diode Recovery dv/dt ③⑥	5.0	V/ns
T_J	Operating Junction and	-55 to + 175	°C
T_{STG}	Storage Temperature Range		
	Soldering Temperature, for 10 seconds		
	Mounting torque, 6-32 or M3 screw	10 lbf•in (1.1N•m)	

Thermal Resistance

	Parameter	Typ.	Max.	Units
$R_{\theta JC}$	Junction-to-Case	—	1.9	°C/W
$R_{\theta JA}$	Junction-to-Ambient	—	65	

Electrical Characteristics @ $T_J = 25^\circ\text{C}$ (unless otherwise specified)

	Parameter	Min.	Typ.	Max.	Units	Conditions
$V_{(BR)DSS}$	Drain-to-Source Breakdown Voltage	150	—	—	V	$V_{GS} = 0V, I_D = 250\mu A$
$\Delta V_{(BR)DSS}/\Delta T_J$	Breakdown Voltage Temp. Coefficient	—	0.20	—	V/°C	Reference to 25°C , $I_D = 1\text{mA}$ ⑥
$R_{DS(on)}$	Static Drain-to-Source On-Resistance	—	—	0.166	Ω	$V_{GS} = 10V, I_D = 7.2A$ ④
		—	—	0.184		$V_{GS} = 5.0V, I_D = 7.2A$ ④
		—	—	0.208		$V_{GS} = 4.0V, I_D = 6A$ ④
$V_{GS(th)}$	Gate Threshold Voltage	1.0	—	2.0	V	$V_{DS} = V_{GS}, I_D = 250\mu A$
g_{fs}	Forward Transconductance	8.3	—	—	S	$V_{DS} = 25V, I_D = 7.2A$ ⑥
I_{DSS}	Drain-to-Source Leakage Current	—	—	25	μA	$V_{DS} = 150V, V_{GS} = 0V$
		—	—	250		$V_{DS} = 120V, V_{GS} = 0V, T_J = 150^\circ\text{C}$
I_{GSS}	Gate-to-Source Forward Leakage	—	—	100	nA	$V_{GS} = 16V$
	Gate-to-Source Reverse Leakage	—	—	-100		$V_{GS} = -16V$
Q_g	Total Gate Charge	—	—	35	nC	$I_D = 7.2A$
Q_{gs}	Gate-to-Source Charge	—	—	4.1		$V_{DS} = 120V$
Q_{gd}	Gate-to-Drain ("Miller") Charge	—	—	21		$V_{GS} = 5.0V$, See Fig. 6 and 13 ④⑥
$t_{d(on)}$	Turn-On Delay Time	—	7.4	—	ns	$V_{DD} = 75V$
t_r	Rise Time	—	45	—		$I_D = 7.2A$
$t_{d(off)}$	Turn-Off Delay Time	—	38	—		$R_G = 12\Omega, V_{GS} = 5.0V$
t_f	Fall Time	—	36	—		$R_D = 10.2\Omega$, See Fig. 10 ④⑥
L_D	Internal Drain Inductance	—	4.5	—	nH	Between lead, 6mm (0.25in.) from package and center of die contact
L_S	Internal Source Inductance	—	7.5	—		
C_{iss}	Input Capacitance	—	775	—	pF	$V_{GS} = 0V$
C_{oss}	Output Capacitance	—	140	—		$V_{DS} = 25V$
C_{rss}	Reverse Transfer Capacitance	—	70	—		$f = 1.0\text{MHz}$, See Fig. 5⑥

Source-Drain Ratings and Characteristics

	Parameter	Min.	Typ.	Max.	Units	Conditions
I_S	Continuous Source Current (Body Diode)	—	—	12⑤	A	MOSFET symbol showing the integral reverse p-n junction diode.
I_{SM}	Pulsed Source Current (Body Diode) ①	—	—	48		
V_{SD}	Diode Forward Voltage	—	—	1.3	V	$T_J = 25^\circ\text{C}, I_S = 7.2A, V_{GS} = 0V$ ④
t_{rr}	Reverse Recovery Time	—	160	240	ns	$T_J = 25^\circ\text{C}, I_F = 7.2A$
Q_{rr}	Reverse Recovery Charge	—	810	1210	nC	$di/dt = 100A/\mu s$ ④⑥
t_{on}	Forward Turn-On Time	Intrinsic turn-on time is negligible (turn-on is dominated by L_S+L_D)				

Notes:

- ① Repetitive rating; pulse width limited by max. junction temperature. (See fig. 11)
- ② Starting $T_J = 25^\circ\text{C}$, $L = 4.9\text{mH}$
 $R_G = 25\Omega, I_{AS} = 7.2A$. (See Figure 12)
- ③ $I_{SD} \leq 7.2A, di/dt \leq 100A/\mu s, V_{DD} \leq V_{(BR)DSS}, T_J \leq 175^\circ\text{C}$
- ④ Pulse width $\leq 300\mu s$; duty cycle $\leq 2\%$.
- ⑤ Calculated continuous current based on maximum allowable junction temperature; for recommended current-handling of the package refer to Design Tip # 93-4.
- ⑥ Uses IRL3215 data and test conditions.

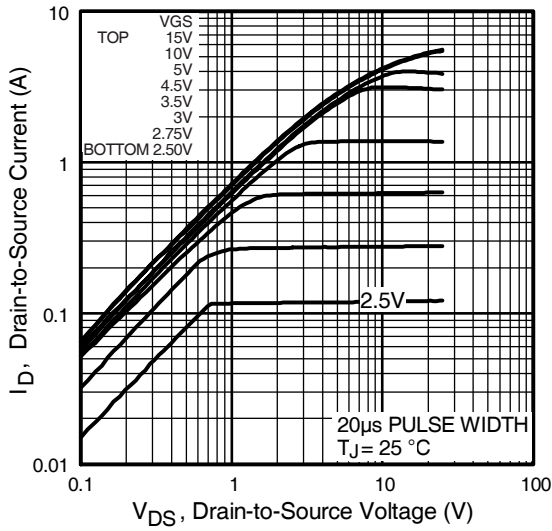

Fig 1. Typical Output Characteristics

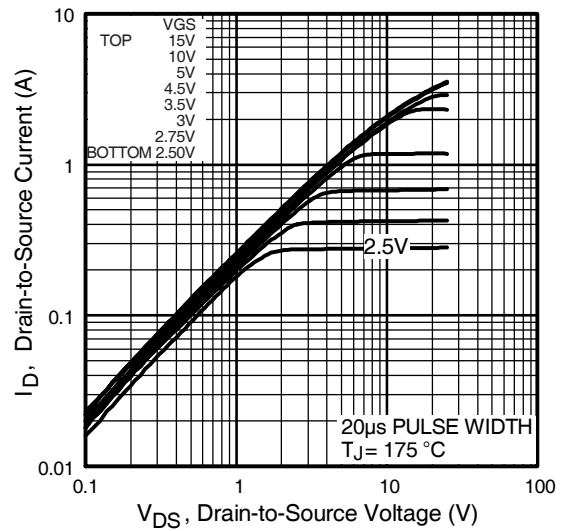

Fig 2. Typical Output Characteristics

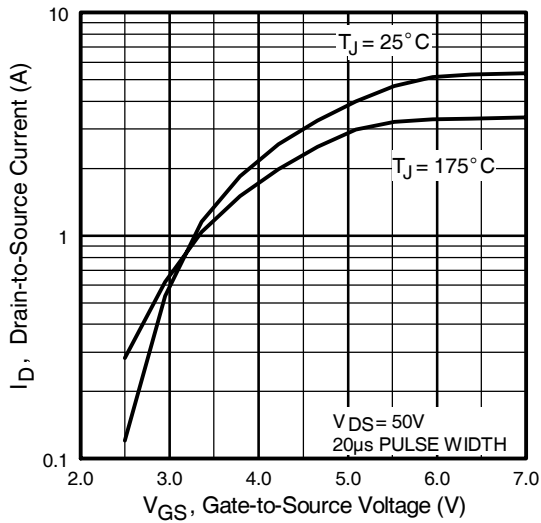

Fig 3. Typical Transfer Characteristics

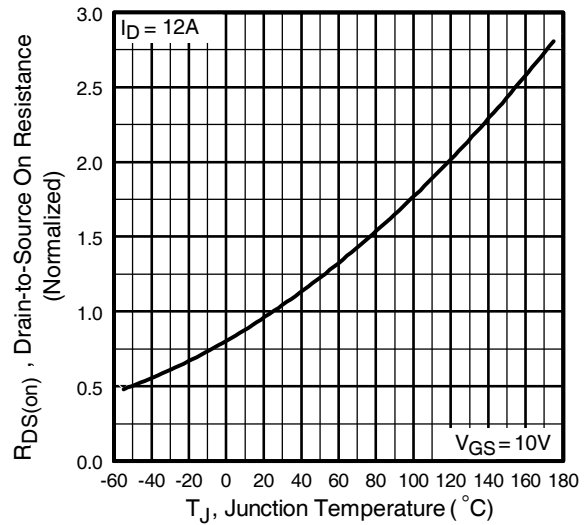

Fig 4. Normalized On-Resistance Vs. Temperature

IRLI3215PbF

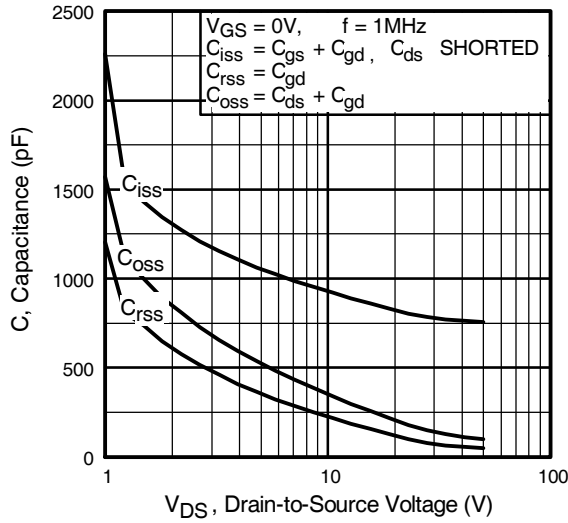

Fig 5. Typical Capacitance Vs. Drain-to-Source Voltage

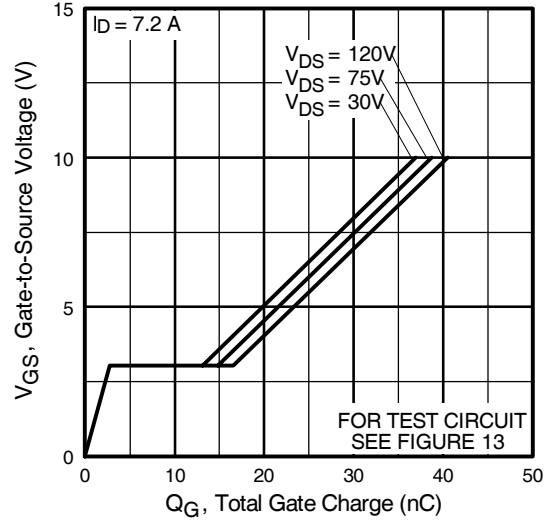

Fig 6. Typical Gate Charge Vs. Gate-to-Source Voltage

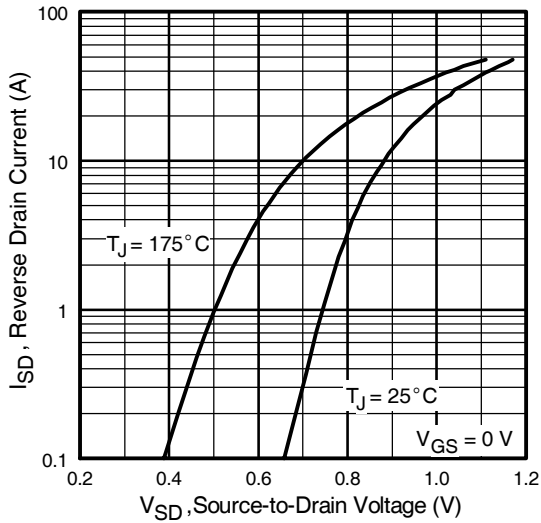

Fig 7. Typical Source-Drain Diode Forward Voltage

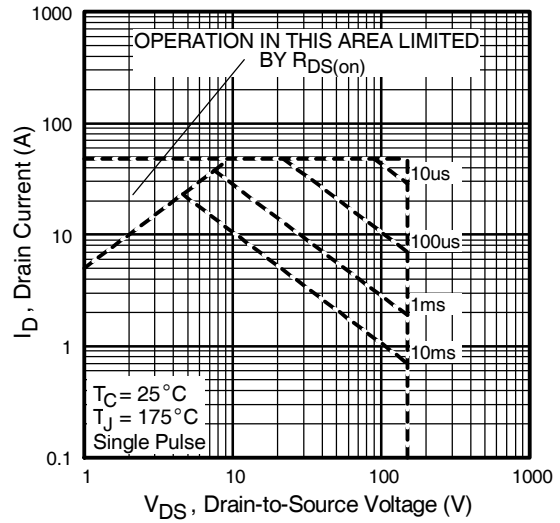

Fig 8. Maximum Safe Operating Area

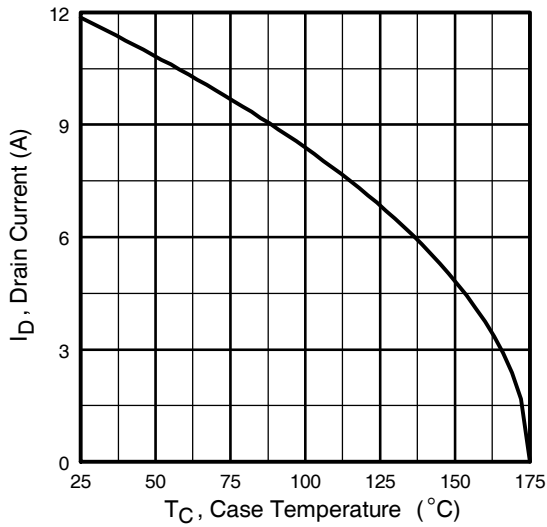

Fig 9. Maximum Drain Current Vs. Case Temperature

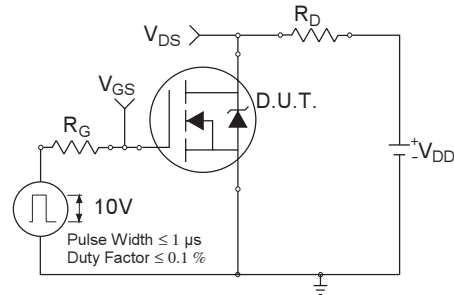

Fig 10a. Switching Time Test Circuit



Fig 10b. Switching Time Waveforms

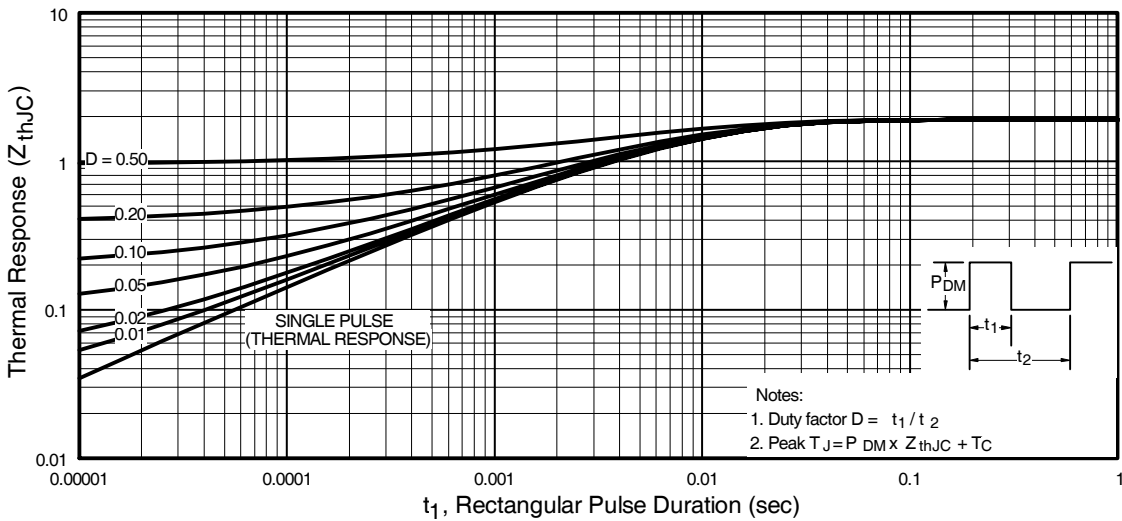

Fig 11. Maximum Effective Transient Thermal Impedance, Junction-to-Case

IRLI3215PbF

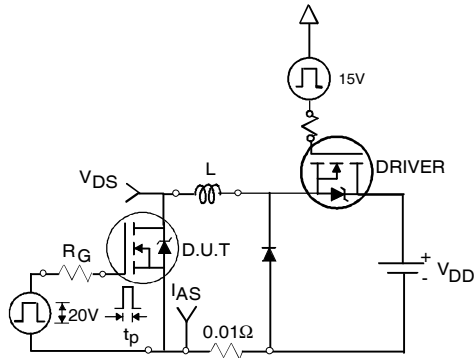

Fig 12a. Unclamped Inductive Test Circuit

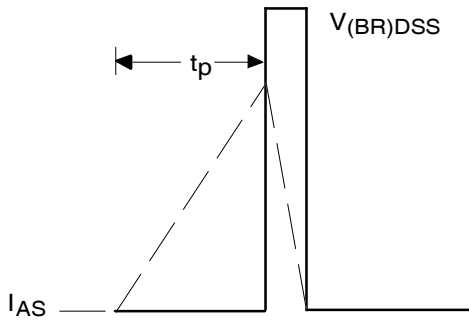

Fig 12b. Unclamped Inductive Waveforms

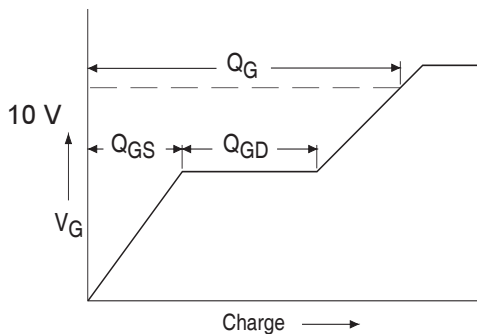

Fig 13a. Basic Gate Charge Waveform

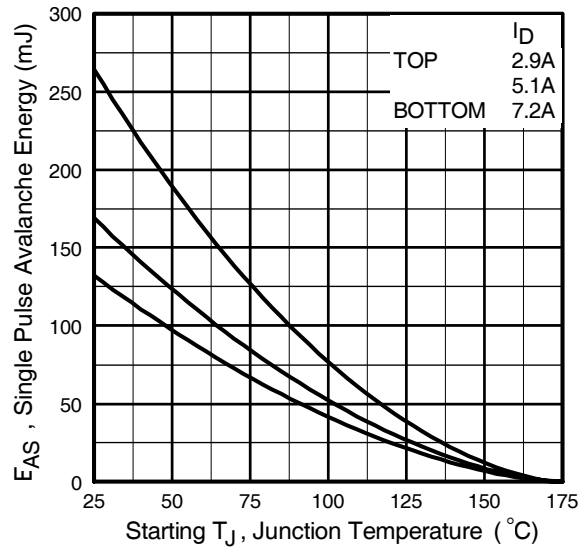

Fig 12c. Maximum Avalanche Energy Vs. Drain Current

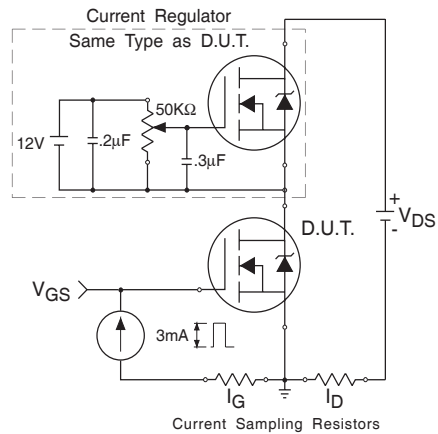

Fig 13b. Gate Charge Test Circuit

Peak Diode Recovery dv/dt Test Circuit



* $V_{GS} = 5V$ for Logic Level Devices

Fig 14. For N-Channel HEXFETS

IRLI3215PbF

International
IR Rectifier

TO-220 Full-Pak Package Outline

Dimensions are shown in millimeters (inches)

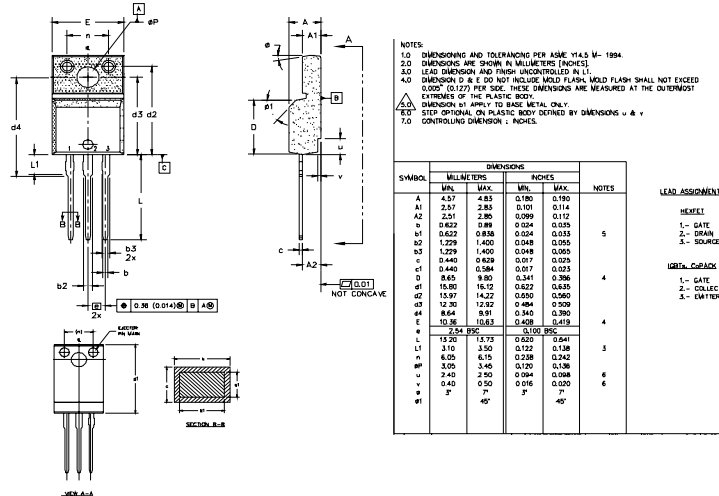

TO-220 Full-Pak Part Marking Information

EXAMPLE: THIS IS AN IRF1840G
 WITH ASSEMBLY
 LOT CODE 3432
 ASSEMBLED ON WW 24 1999
 IN THE ASSEMBLY LINE "K"
Note: "P" in assembly line
 position indicates "Lead-Free"

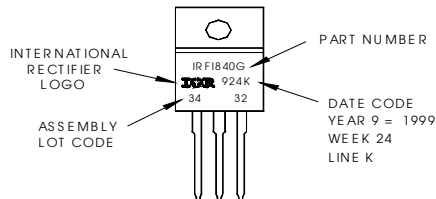

Data and specifications subject to change without notice.
 This product has been designed and qualified for the Industrial market.
 Qualification Standards can be found on IR's Web site.

International
IR Rectifier

IR WORLD HEADQUARTERS: 233 Kansas St., El Segundo, California 90245, USA Tel: (310) 252-7105

TAC Fax: (310) 252-7903

Visit us at www.irf.com for sales contact information.02/04

www.irf.com

Note: For the most current drawings please refer to the IR website at:
<http://www.irf.com/package/>