

IRHNKC9A97130 (JANSR2N7660U3CE)

PD-97998A

Radiation Hardened Power MOSFET Surface Mount (SMD-0.5e Ceramic Lid) -100V, -24A, P-channel, R9 Superjunction Technology

Features

- Single event effect (SEE) hardened (up to LET of 91.2 MeV·cm²/mg)
- Low R_{DS(on)}
- Rugged SOA
- Improved Avalanche Energy
- Simple drive requirements
- Hermetically sealed
- Ceramic package
- Light weight
- Surface mount
- ESD rating: Class 2 per MIL-STD-750, Method 1020

Product Summary

- **BV_{DSS}**: -100V
- **I_D**: -24A
- **R_{DS(on),max}**: 72mΩ
- **Q_{Gmax}**: 50nC
- **REF**: MIL-PRF-19500/780



Potential Applications

- Power distribution
- Latching current limiter
- Motor drives
- DC-DC converter

Product Validation

Qualified according to MIL-PRF-19500 for space applications

Description

IR HiRel R9 technology provides superior power MOSFETs for space applications. These devices have improved immunity to Single Event Effect (SEE) and have been characterized for useful performance with Linear Energy Transfer (LET) up to 91.2 MeV·cm²/mg. Their combination of low R_{DS(on)} and improved SOA will allow for better performance in applications such as Latching Current Limiters or Solid-State Power Controllers. These devices retain all of the well-established advantages of MOSFETs such as voltage control, fast switching and temperature stability of electrical parameters.

Ordering Information

Table 1 **Ordering options**

Part number	Package	Screening Level	TID Level
IRHNKC9A97130	SMD-0.5e (Ceramic Lid)	COTS	100 krad(Si)
JANSR2N7660U3CE	SMD-0.5e (Ceramic Lid)	JANS	100 krad(Si)
IRHNKC9A93130	SMD-0.5e (Ceramic Lid)	COTS	300 krad(Si)
JANSF2N7660U3CE	SMD-0.5e (Ceramic Lid)	JANS	300 krad(Si)

Table of contents

Table of contents

Features	1
Potential Applications.....	1
Product Validation.....	1
Description	1
Ordering Information.....	1
Table of contents.....	2
1 Absolute Maximum Ratings	3
2 Device Characteristics	4
2.1 Electrical Characteristics (Pre-Irradiation).....	4
2.2 Source-Drain Diode Ratings and Characteristics (Pre-Irradiation)	5
2.3 Thermal Characteristics	5
2.4 Radiation Characteristics.....	5
2.4.1 Electrical Characteristics — Post Total Dose Irradiation	5
2.4.2 Single Event Effects — Safe Operating Area.....	6
3 Electrical Characteristics Curves (Pre-irradiation)	7
4 Test Circuits (Pre-irradiation)	11
5 Package Outline.....	12
Revision history.....	13

Absolute Maximum Ratings

1 Absolute Maximum Ratings

Table 2 Absolute Maximum Ratings (Pre-Irradiation)

Symbol	Parameter	Value	Unit
$I_{D1} @ V_{GS} = -12V, T_C = 25^\circ C$	Continuous Drain Current	-24	A
$I_{D2} @ V_{GS} = -12V, T_C = 100^\circ C$	Continuous Drain Current	-15	A
$I_{DM} @ T_C = 25^\circ C$	Pulsed Drain Current ¹	-96	A
$P_D @ T_C = 25^\circ C$	Maximum Power Dissipation	75	W
	Linear Derating Factor	0.6	W/°C
V_{GS}	Gate-to-Source Voltage	± 20	V
E_{AS}	Single Pulse Avalanche Energy ²	810	mJ
I_{AR}	Avalanche Current ¹	-15	A
E_{AR}	Repetitive Avalanche Energy ¹	7.5	mJ
dv/dt	Peak Diode Reverse Recovery ³	-11	V/ns
T_J T_{STG}	Operating Junction and Storage Temperature Range	-55 to +150	°C
	Lead Temperature	300 (for 5s)	
	Weight	1.0 (Typical)	g

¹ Repetitive Rating; Pulse width limited by maximum junction temperature.

² $V_{DD} = -100V$, starting $T_J = 25^\circ C$, $L = 7.2mH$, Peak $I_L = -15A$, $V_{GS} = -20V$

³ $I_{SD} \leq -24A$, $di/dt \leq -1050A/\mu s$, $V_{DD} \leq -100V$, $T_J \leq 150^\circ C$

Device Characteristics

2 Device Characteristics

2.1 Electrical Characteristics (Pre-Irradiation)

Table 3 Static and Dynamic Electrical Characteristics @ T_j = 25°C (Unless Otherwise Specified)

Symbol	Parameter	Min.	Typ.	Max.	Unit	Test Conditions
B _{V_{DSS}}	Drain-to-Source Breakdown Voltage	-100	—	—	V	V _{GS} = 0V, I _D = -1.0mA
ΔB _{V_{DSS}} /ΔT _J	Breakdown Voltage Temp. Coefficient	—	0.11	—	V/°C	Reference to 25°C, I _D = -1.0mA
R _{DS(on)}	Static Drain-to-Source On-State Resistance	—	—	72	mΩ	V _{GS} = -12V, I _{D2} = -15A ¹
V _{GS(th)}	Gate Threshold Voltage	-2.0	—	-4.0	V	V _{DS} ≥ V _{GS} , I _D = -1mA
ΔV _{GS(th)} /ΔT _J	Gate Threshold Voltage Coefficient	—	5.6	—	mV/°C	
G _{fs}	Forward Transconductance	14	—	—	S	V _{DS} = -15V, I _{D2} = -15A ¹
I _{DSS}	Zero Gate Voltage Drain Current	—	—	-10	μA	V _{DS} = -80V, V _{GS} = 0V
		—	—	-25		V _{DS} = -80V, V _{GS} = 0V, T _J = 125°C
I _{GSS}	Gate-to-Source Leakage Forward	—	—	-100	nA	V _{GS} = -20V
	Gate-to-Source Leakage Reverse	—	—	100		V _{GS} = 20V
Q _G	Total Gate Charge	—	—	50	nC	I _{D1} = -24A
Q _{GS}	Gate-to-Source Charge	—	—	16		V _{DS} = -50V
Q _{GD}	Gate-to-Drain ('Miller') Charge	—	—	12		V _{GS} = -12V
t _{d(on)}	Turn-On Delay Time	—	—	18	ns	I _{D1} = -24A ^{**} V _{DD} = -50V R _G = 7.5Ω V _{GS} = -12V
t _r	Rise Time	—	—	48		
t _{d(off)}	Turn-Off Delay Time	—	—	74		
t _f	Fall Time	—	—	39		
L _s + L _D	Total Inductance	—	4.0	—	nH	Measured from center of Drain pad to center of Source pad
C _{iss}	Input Capacitance	—	2465	—	pF	V _{GS} = 0V V _{DS} = -25V f = 1.0MHz
C _{oss}	Output Capacitance	—	524	—		
C _{rss}	Reverse Transfer Capacitance	—	14	—		
R _G	Gate Resistance	—	5.6	—	Ω	f = 1.0MHz, open drain

** Switching speed maximum limits are based on manufacturing test equipment and capability.

¹ Pulse width ≤ 300 μs; Duty Cycle ≤ 2%

Device Characteristics

2.2 Source-Drain Diode Ratings and Characteristics (Pre-Irradiation)

Table 4 Source-Drain Diode Characteristics

Symbol	Parameter	Min.	Typ.	Max.	Unit	Test Conditions
I_S	Continuous Source Current (Body Diode)	—	—	-24	A	
I_{SM}	Pulsed Source Current (Body Diode) ¹	—	—	-196	A	
V_{SD}	Diode Forward Voltage	—	—	-1.3	V	$T_J = 25^\circ\text{C}$, $I_S = -24\text{A}$, $V_{GS} = 0\text{V}$ ²
t_{rr}	Reverse Recovery Time	—	73	110	ns	$T_J = 25^\circ\text{C}$, $I_F = -24\text{A}$, $V_{DD} \leq -25\text{V}$ $di/dt = -100\text{A}/\mu\text{s}$
Q_{rr}	Reverse Recovery Charge	—	258	—	nC	
t_{on}	Forward Turn-On Time	Intrinsic turn-on time is negligible (turn-on is dominated by L_S+L_D)				

2.3 Thermal Characteristics

Table 5 Thermal Resistance

Symbol	Parameter	Min.	Typ.	Max.	Unit
$R_{\theta JC}$	Junction-to-Case	—	—	1.67	$^\circ\text{C}/\text{W}$

2.4 Radiation Characteristics

IR HiRel radiation hardened MOSFETs are tested to verify their radiation hardness capability. The hardness assurance program at IR HiRel is comprised of two radiation environments. Every manufacturing lot is tested for total ionizing dose (per notes 3 and 4) using the TO-3 package. Both pre- and post-irradiation performance are tested and specified using the same drive circuitry and test conditions in order to provide a direct comparison.

2.4.1 Electrical Characteristics — Post Total Dose Irradiation

Table 6 Electrical Characteristics @ $T_J = 25^\circ\text{C}$, Post Total Dose Irradiation^{3, 4}

Symbol	Parameter	Up to 300 krad (Si) ⁵		Unit	Test Conditions
		Min.	Max.		
BV_{DSS}	Drain-to-Source Breakdown Voltage	-100	—	V	$V_{GS} = 0\text{V}$, $I_D = -1.0\text{mA}$
$V_{GS(th)}$	Gate Threshold Voltage	-2.0	-4.0	V	$V_{DS} \geq V_{GS}$, $I_D = -1.0\text{mA}$
I_{GSS}	Gate-to-Source Leakage Forward	—	-100	nA	$V_{GS} = -20\text{V}$
	Gate-to-Source Leakage Reverse	—	100		$V_{GS} = 20\text{V}$
I_{DSS}	Zero Gate Voltage Drain Current	—	-10	μA	$V_{DS} = -80\text{V}$, $V_{GS} = 0\text{V}$
$R_{DS(on)}$	Static Drain-to-Source On-State Resistance (TO-3) ²	—	73	m Ω	$V_{GS} = -12\text{V}$, $I_{D2} = -15\text{A}$
$R_{DS(on)}$	Static Drain-to-Source On-State Resistance (SMD-0.5e) ²	—	72	m Ω	$V_{GS} = -12\text{V}$, $I_{D2} = -15\text{A}$
V_{SD}	Diode Forward Voltage	—	-1.3	V	$V_{GS} = 0\text{V}$, $I_F = -24\text{A}$

¹ Repetitive Rating; Pulse width limited by maximum junction temperature.

² Pulse width $\leq 300 \mu\text{s}$; Duty Cycle $\leq 2\%$

³ Total Dose Irradiation with V_{GS} Bias. $V_{GS} = -12\text{V}$ applied and $V_{DS} = 0$ during irradiation per MIL-STD-750, Method 1019, condition A.

⁴ Total Dose Irradiation with V_{DS} Bias. $V_{DS} = -80\text{V}$ applied and $V_{GS} = 0$ during irradiation per MIL-STD-750, Method 1019, condition A.

⁵ Part numbers IRHNKC9A97130 (JANSR2N7660U3CE) and IRHNKC9A93130 (JANSF2N7660U3CE)

Device Characteristics

2.4.2 Single Event Effects — Safe Operating Area

IR HiRel radiation hardened MOSFETs have been characterized in heavy ion environment for Single Event Effects (SEE). Single Event Effects characterization is illustrated in Fig. 1 and Table 7.

Table 7 Typical Single Event Effects Safe Operating Area

LET (MeV·cm ² /mg)	Energy (MeV)	Range (μm)	V _{DS} (V)			
			V _{GS} = 0V	V _{GS} = 1V	V _{GS} = 5V	V _{GS} = 10V
38.5 ± 2%	336.5 ± 5%	41.4 ± 5%	-100	-100	-100	-100
61.3 ± 2%	623.5 ± 5%	51.5 ± 5%	-100	-100	-100	---
91.2 ± 2%	1322.5 ± 5%	72.9 ± 5%	-100	-100	—	—

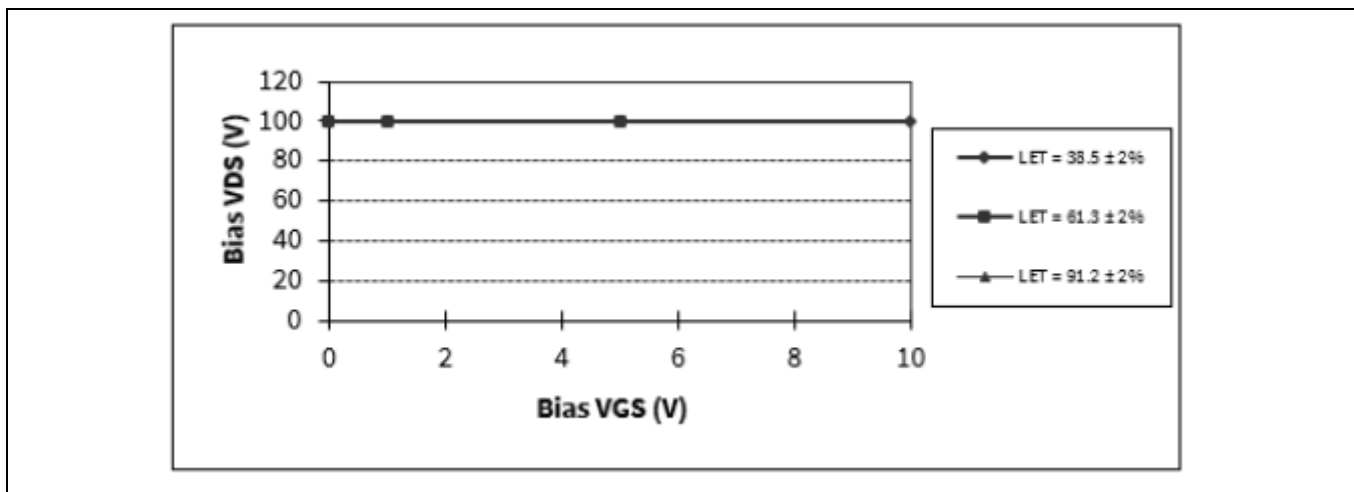

Figure 1 Typical Single Event Effect, Safe Operating Area

Electrical Characteristics Curves (Pre-irradiation)

3 Electrical Characteristics Curves (Pre-irradiation)

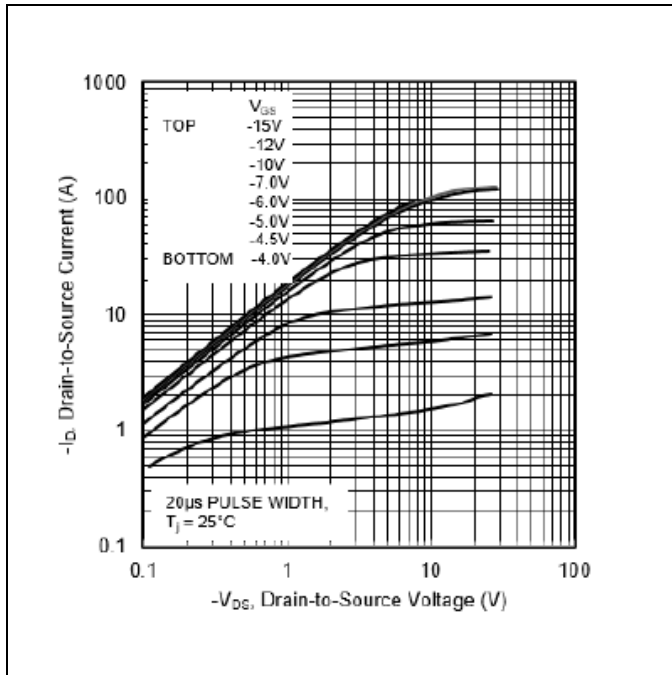

Figure 2 Typical Output Characteristics

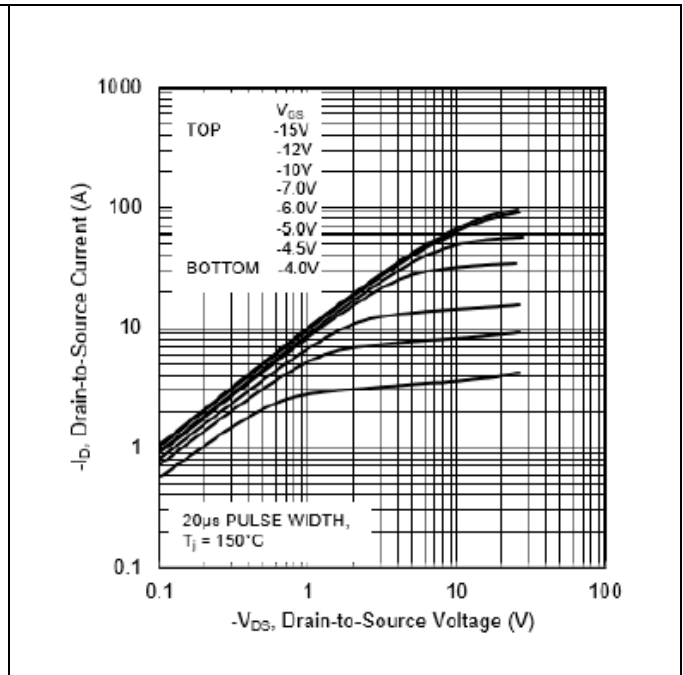

Figure 3 Typical Output Characteristics

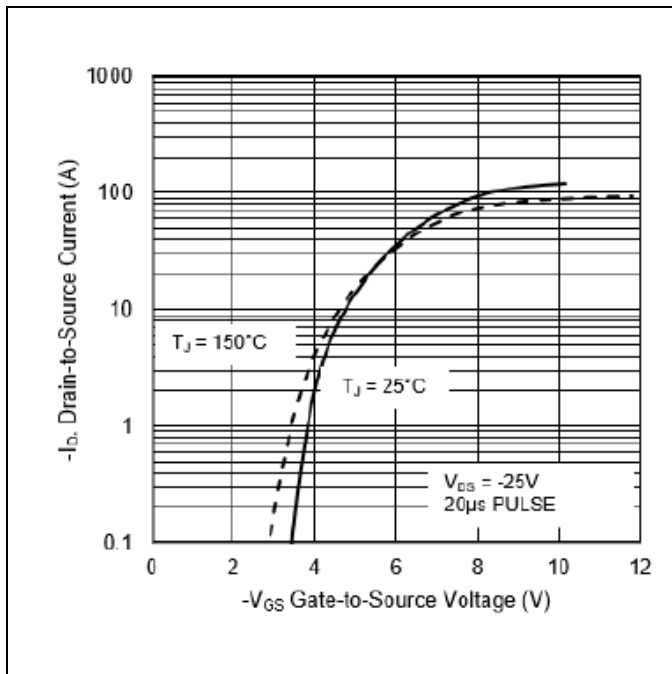

Figure 4 Typical Transfer Characteristics

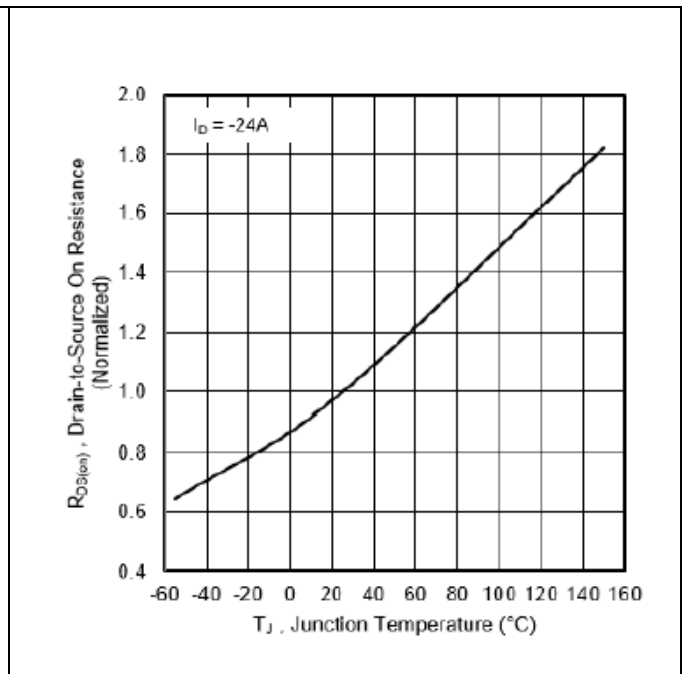

Figure 5 Normalized On-Resistance Vs. Temperature

IRHNKC9A97130 (JANSR2N7660U3CE)
Radiation Hardened Power MOSFET (SMD-0.5e)
Electrical Characteristics Curves (Pre-irradiation)

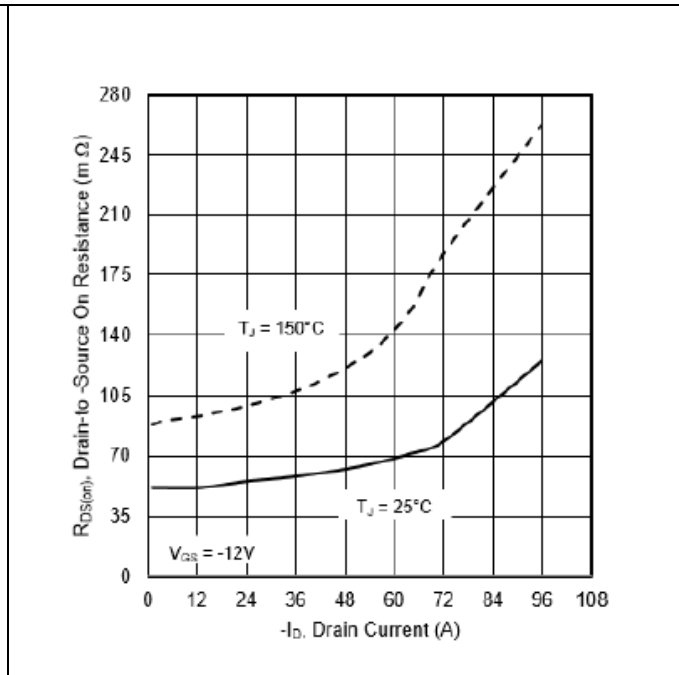
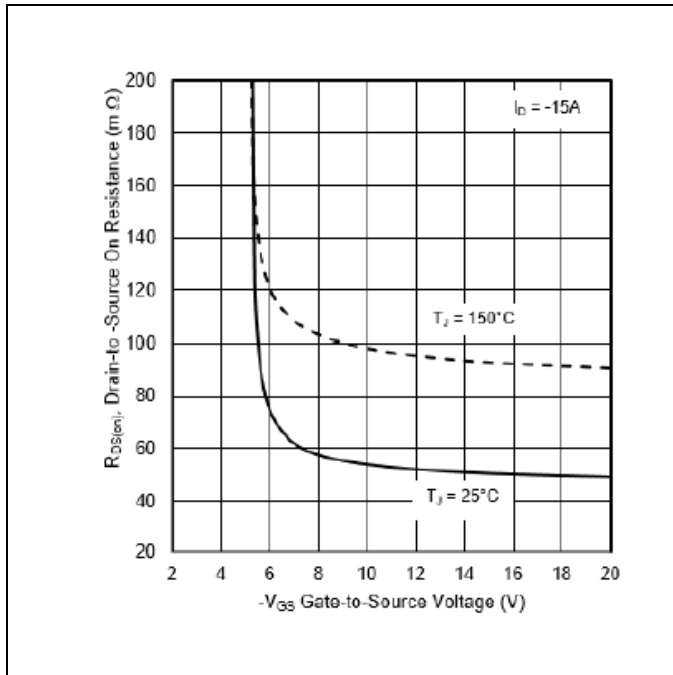

Figure 6 Typical On-Resistance Vs Gate Voltage

Figure 7 Typical On-Resistance Vs Drain Current

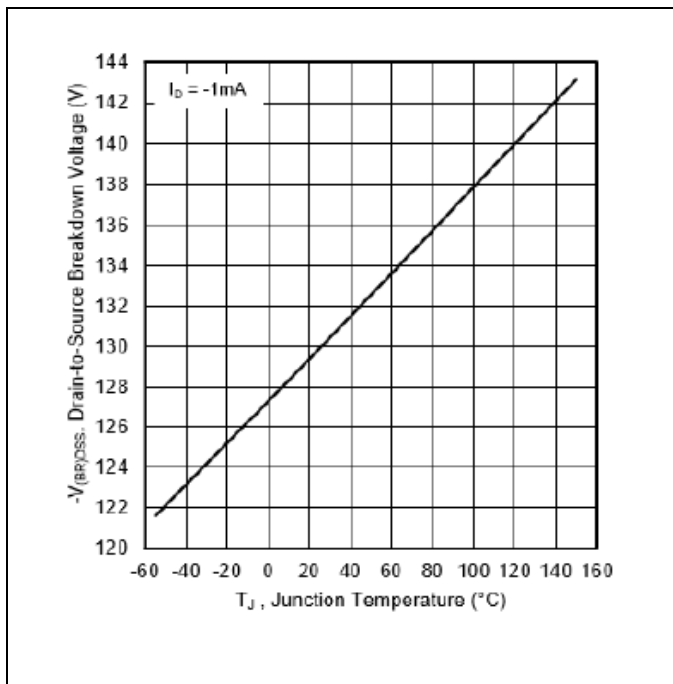

Figure 8 Typical Drain-to-Source Breakdown Voltage Vs. Temperature

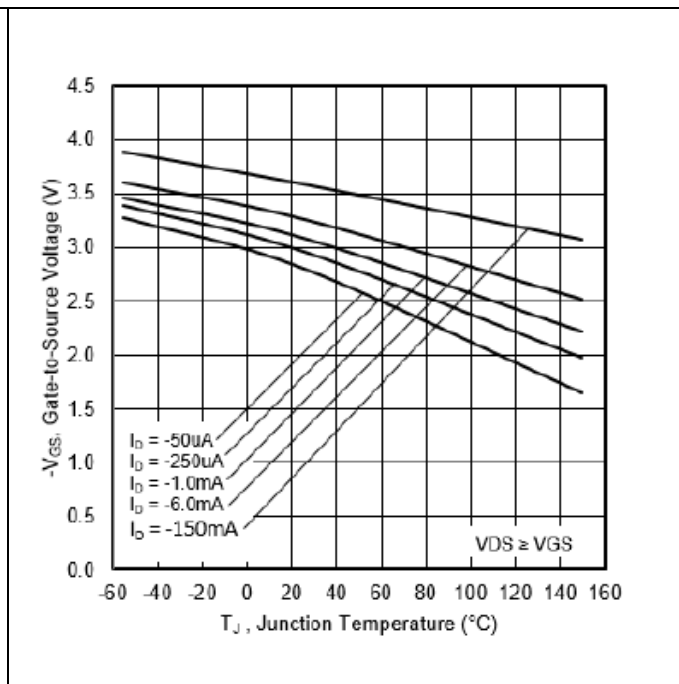

Figure 9 Typical Threshold Voltage Vs. Temperature

IRHNKC9A97130 (JANSR2N7660U3CE)
Radiation Hardened Power MOSFET (SMD-0.5e)
Electrical Characteristics Curves (Pre-irradiation)

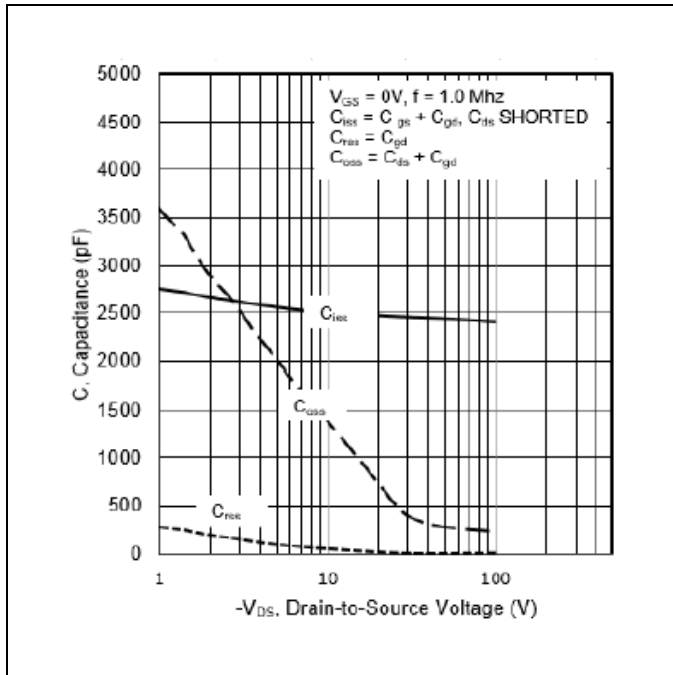

Figure 10 Typical Capacitance Vs. Drain-to-Source Voltage

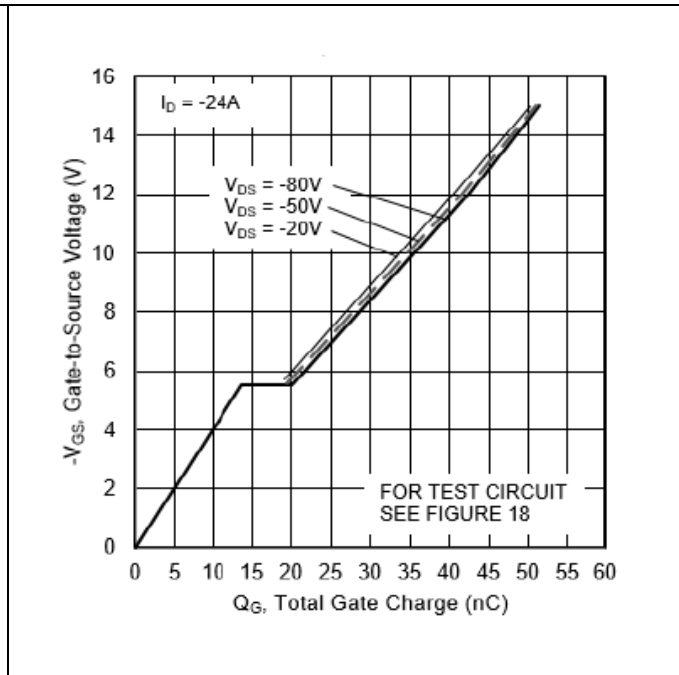

Figure 11 Gate-to-Source Voltage Vs. Typical Gate Charge

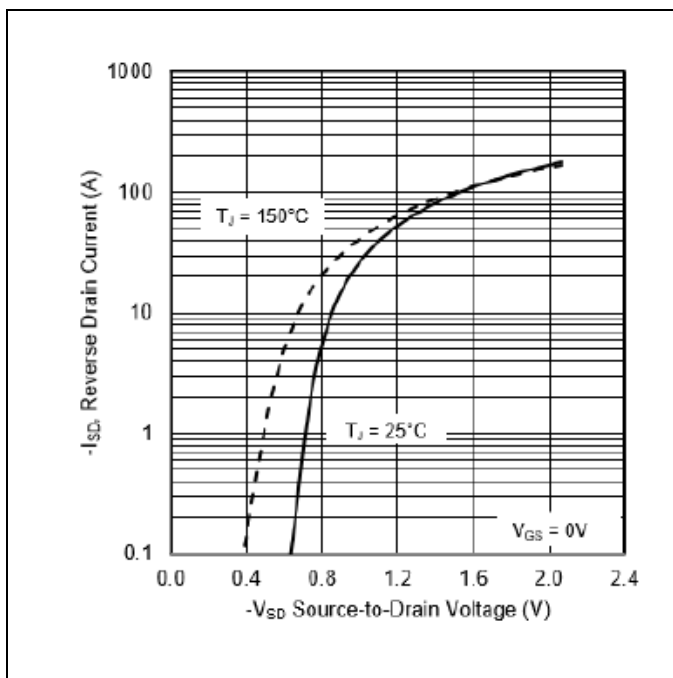

Figure 12 Typical Source-Drain Current Vs. Diode Forward Voltage

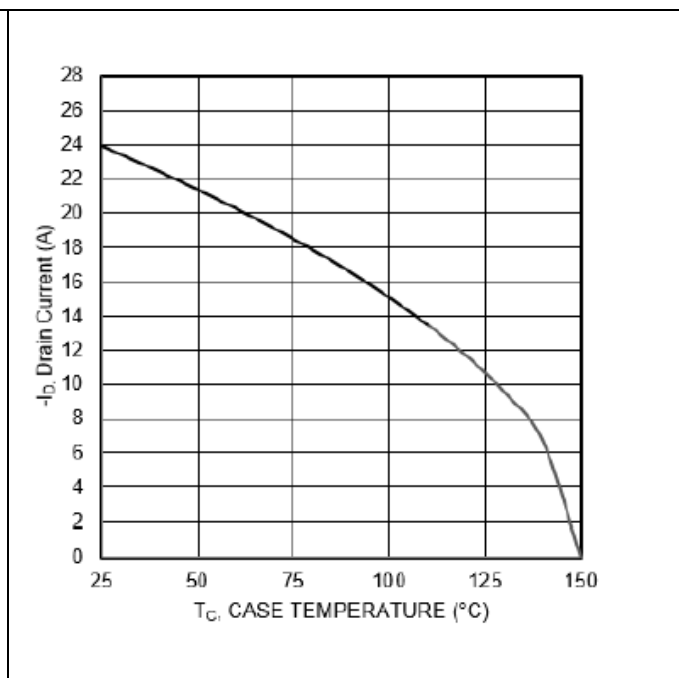

Figure 13 Maximum Drain Current Vs. Case Temperature

IRHNKC9A97130 (JANSR2N7660U3CE)
Radiation Hardened Power MOSFET (SMD-0.5e)
Electrical Characteristics Curves (Pre-irradiation)

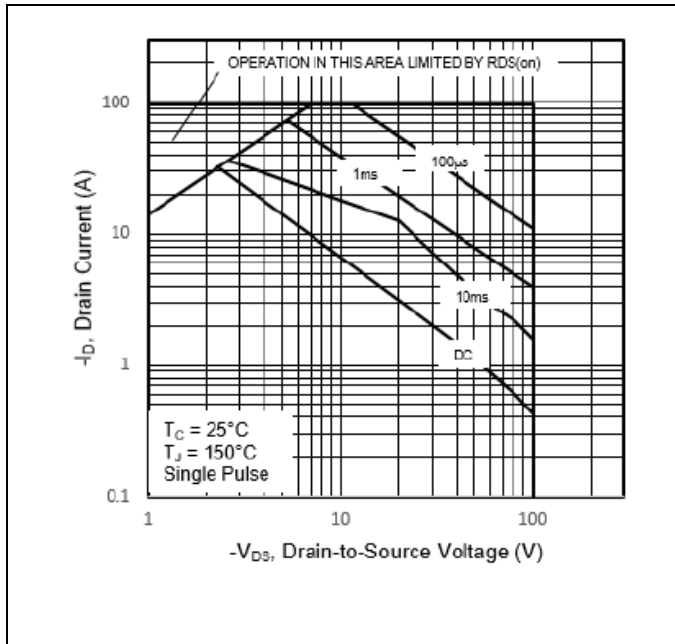

Figure 14 Maximum Safe Operating Area

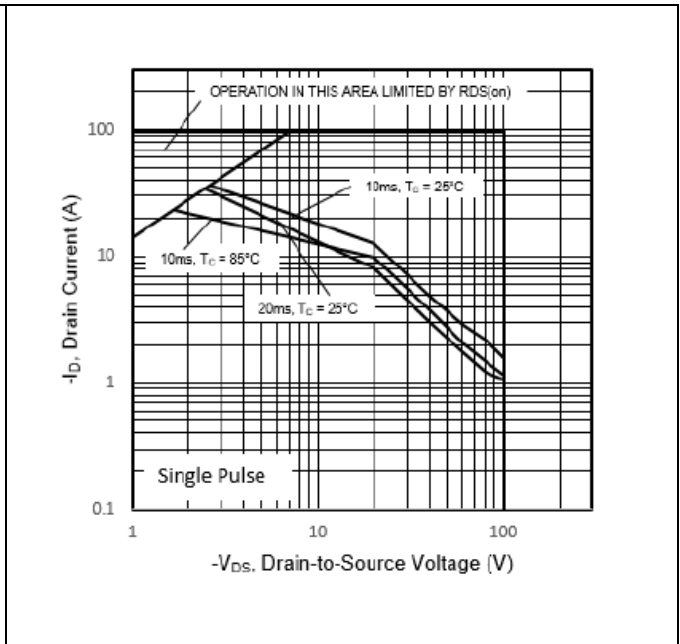

Figure 15 Maximum Safe Operating Area

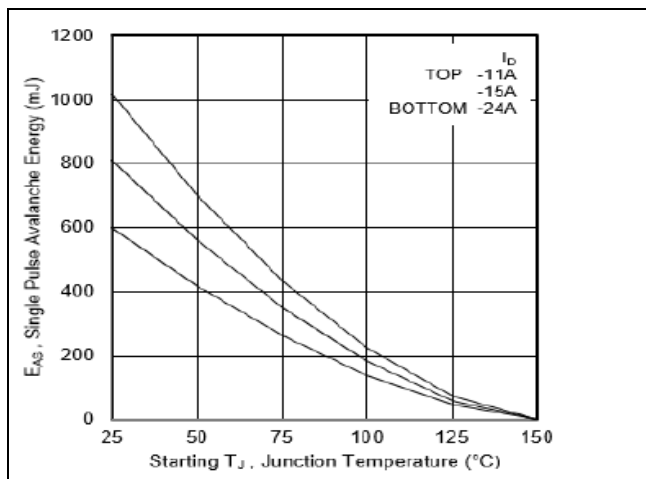

Figure 16 Maximum Avalanche Energy Vs. Junction Temperature

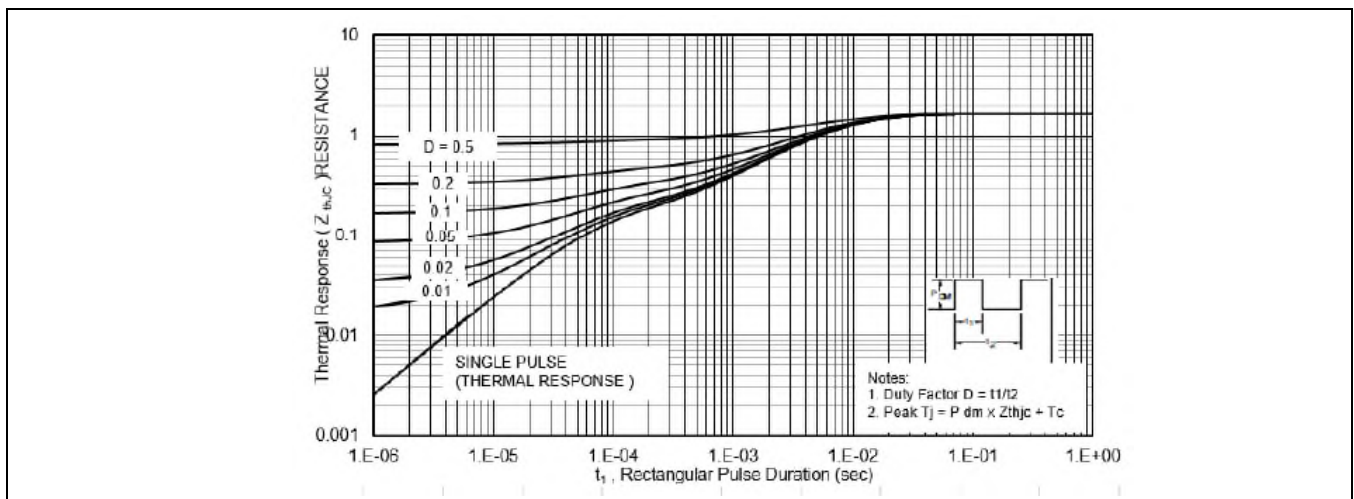

Figure 17 Maximum Effective Transient Thermal Impedance, Junction-to-Case

IRHNKC9A97130 (JANSR2N7660U3CE)
Radiation Hardened Power MOSFET (SMD-0.5e)

Test Circuits (Pre-irradiation)

4 Test Circuits (Pre-irradiation)

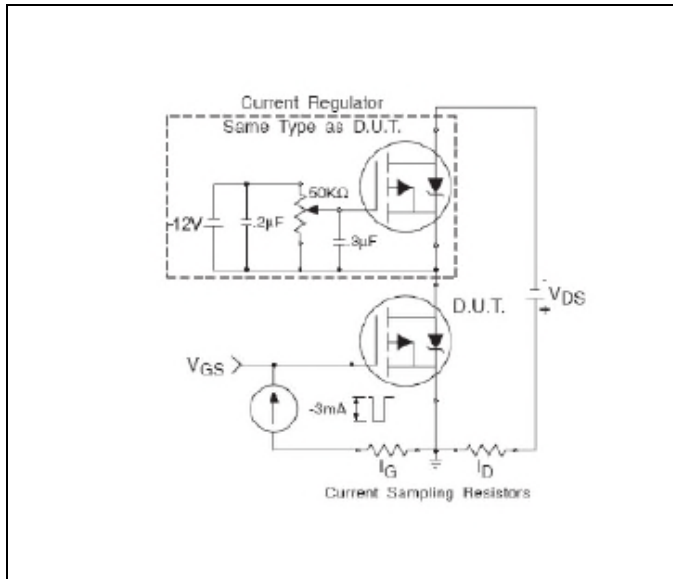

Figure 18 Gate Charge Test Circuit

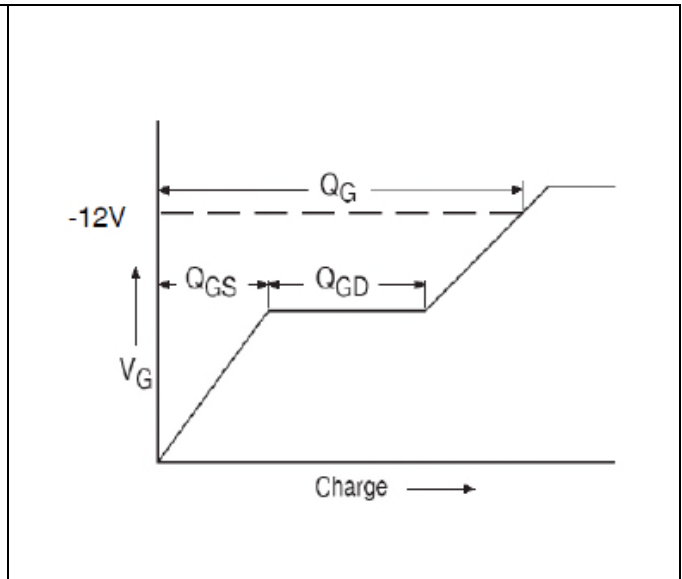

Figure 19 Gate Charge Waveform

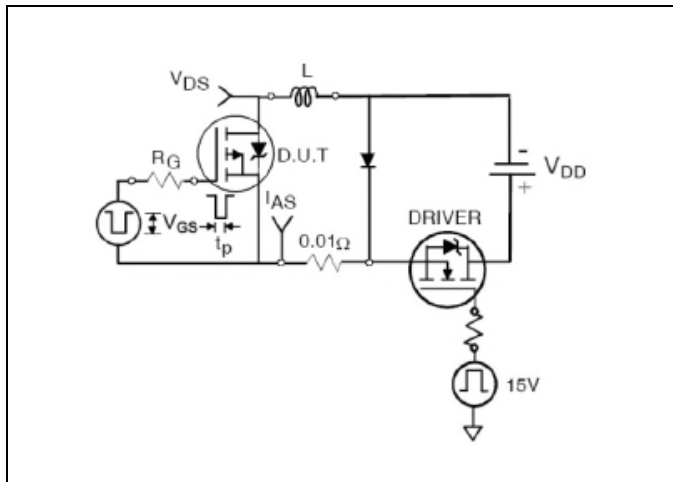

Figure 20 Unclamped Inductive Test Circuit

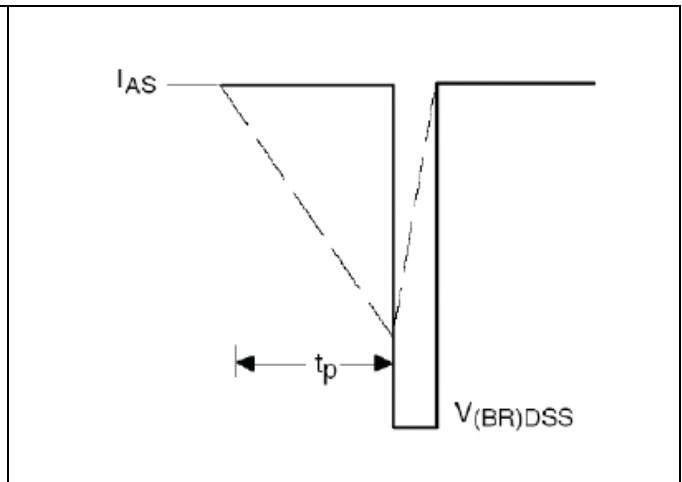

Figure 21 Unclamped Inductive Waveform

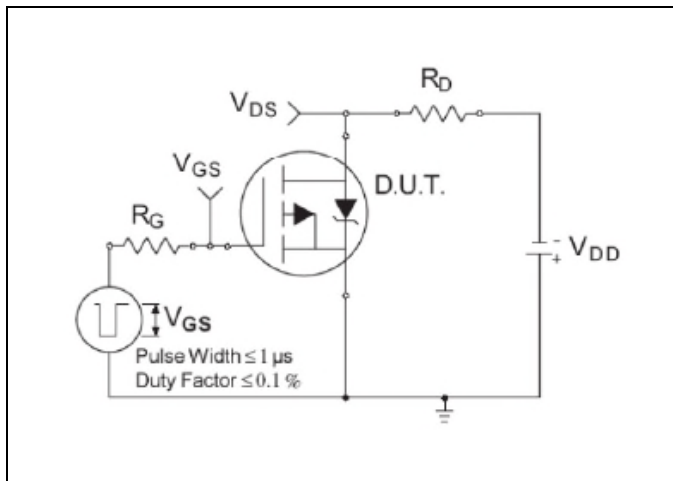

Figure 22 Switching Time Test Circuit

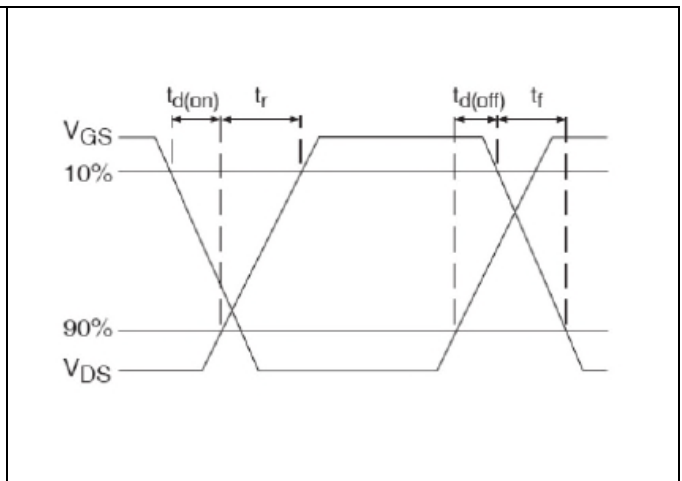

Figure 23 Switching Time Waveforms

IRHNKC9A97130 (JANSR2N7660U3CE)
Radiation Hardened Power MOSFET (SMD-0.5e)

Revision history

Revision history

Document version	Date of release	Description of changes
	10/24/2022	Preliminary datasheet with PPD number (PPD-97998)
Rev A	12/19/2022	Final datasheet with PD number (PD-97998A)

Trademarks

All referenced product or service names and trademarks are the property of their respective owners.

Edition 2022-12-19

Published by

**International Rectifier HiRel Products,
Inc.**

**An Infineon Technologies company
El Segundo, California 90245 USA**

**© 2022 Infineon Technologies AG.
All Rights Reserved.**

**Do you have a question about this
document?**

Email: erratum@infineon.com

Document reference

IMPORTANT NOTICE

The information given in this document shall in no event be regarded as a guarantee of conditions or characteristics ("Beschaffheitsgarantie").

With respect to any examples, hints or any typical values stated herein and/or any information regarding the application of the product, Infineon Technologies hereby disclaims any and all warranties and liabilities of any kind, including without limitation warranties of non-infringement of intellectual property rights of any third party.

In addition, any information given in this document is subject to customer's compliance with its obligations stated in this document and any applicable legal requirements, norms and standards concerning customer's products and any use of the product of Infineon Technologies in customer's applications.

The data contained in this document is exclusively intended for technically trained staff. It is the responsibility of customer's technical departments to evaluate the suitability of the product for the intended application and the completeness of the product information given in this document with respect to such application.

For further information on the product, technology, delivery terms and conditions and prices please contact your nearest Infineon Technologies office (www.infineon.com).

WARNINGS

Due to technical requirements components may contain dangerous substances. For information on the types in question please contact your nearest International Rectifier HiRel Products, Inc., an Infineon Technologies company, office.

International Rectifier HiRel Components may only be used in life-support devices or systems with the expressed written approval of International Rectifier HiRel Products, Inc., an Infineon Technologies company, if failure of such components can reasonably be expected to cause the failure of that life-support device or system, or to affect the safety and effectiveness of that device or system.

Life support devices or systems are intended to be implanted in the human body, or to support and/or maintain and sustain and/or protect human life. If they fail, it is reasonable to assume that the health of the user or other persons may be endangered.