

IRHMS9A7264

PD-97959B

Radiation Hardened Power MOSFET Thru-Hole (TO-254AA Low Ohmic) 250V, 45A, N-channel, R9 Superjunction Technology

Features

- Single event effect (SEE) hardened (up to LET of 88.2 MeV·cm²/mg)
- Low R_{DS(on)}
- Fast switching
- Low total gate charge
- Simple drive requirements
- Hermetically sealed
- Electrically isolated
- Ceramic eyelets
- Light weight
- ESD rating: Class 3B per MIL-STD-750, Method 1020

Potential Applications

- DC-DC converter
- Motor drives

Product Validation

Qualified according to MIL-PRF-19500 for space applications

Description

IR HiRel R9 technology provides superior power MOSFETs for space applications. These devices have improved immunity to Single Event Effect (SEE) and have been characterized for useful performance with Linear Energy Transfer (LET) up to 88.2 MeV·cm²/mg. Their combination of low R_{DS(on)} and fast switching times will allow for better performance in applications such as DC-DC converters or motor drives. These devices retain all of the well-established advantages of MOSFETs such as voltage control, fast switching and temperature stability of electrical parameters.

Ordering Information

Table 1 Ordering options

Part number	Package	Screening Level	TID Level
IRHMS9A7264	Low-Ohmic TO-254AA	COTS	100 krad (Si)
IRHMS9A3264	Low-Ohmic TO-254AA	COTS	300 krad (Si)

Product Summary

- BV_{DSS}: 250V
- I_D: 45A*
- R_{DS(on),max}: 19.5mΩ
- Q_{Gmax}: 165nC



Table of contents

Table of contents

Features	1
Potential Applications.....	1
Product Validation.....	1
Description	1
Ordering Information.....	1
Table of contents.....	2
1 Absolute Maximum Ratings	3
2 Device Characteristics	4
2.1 Electrical Characteristics (Pre-Irradiation).....	4
2.2 Source-Drain Diode Ratings and Characteristics (Pre-Irradiation)	5
2.3 Thermal Characteristics	5
2.4 Radiation Characteristics.....	5
2.4.1 Electrical Characteristics — Post Total Dose Irradiation	5
2.4.2 Single Event Effects — Safe Operating Area	6
3 Electrical Characteristics Curves (Pre-irradiation)	7
4 Test Circuits (Pre-irradiation)	11
5 Package Outline.....	12
Revision history.....	13

Absolute Maximum Ratings

1 Absolute Maximum Ratings

Table 2 Absolute Maximum Ratings (Pre-Irradiation)

Symbol	Parameter	Value	Unit
$I_{D1} @ V_{GS} = 12V, T_C = 25^\circ C$	Continuous Drain Current	45*	A
$I_{D2} @ V_{GS} = 12V, T_C = 100^\circ C$	Continuous Drain Current	45*	A
$I_{DM} @ T_C = 25^\circ C$	Pulsed Drain Current ¹	180	A
$P_D @ T_C = 25^\circ C$	Maximum Power Dissipation	208	W
	Linear Derating Factor	1.7	W/°C
V_{GS}	Gate-to-Source Voltage	± 20	V
E_{AS}	Single Pulse Avalanche Energy ²	2531	mJ
I_{AR}	Avalanche Current ¹	45	A
E_{AR}	Repetitive Avalanche Energy ¹	20.8	mJ
dv/dt	Peak Diode Reverse Recovery ³	35	V/ns
T_J T_{STG}	Operating Junction and Storage Temperature Range	-55 to +150	°C
	Lead Temperature	300 (0.063 in. /1.6 mm from case for 10s)	
	Weight	9.3 (Typical)	

*Current is limited by package

¹ Repetitive Rating; Pulse width limited by maximum junction temperature.² $V_{DD} = 125V$, starting $T_J = 25^\circ C$, $L = 2.5mH$, Peak $I_L = 45A$, $V_{GS} = 20V$ ³ $I_{SD} \leq 45A$, $di/dt \leq 1940A/\mu s$, $V_{DD} \leq 250V$, $T_J \leq 150^\circ C$

Device Characteristics

2 Device Characteristics

2.1 Electrical Characteristics (Pre-Irradiation)

Table 3 Static and Dynamic Electrical Characteristics @ $T_j = 25^\circ\text{C}$ (Unless Otherwise Specified)

Symbol	Parameter	Min.	Typ.	Max.	Unit	Test Conditions
BV_{DSS}	Drain-to-Source Breakdown Voltage	250	—	—	V	$V_{GS} = 0V, I_D = 1.0mA$
$\Delta BV_{DSS}/\Delta T_J$	Breakdown Voltage Temp. Coefficient	—	0.20	—	V/ $^\circ\text{C}$	Reference to 25°C , $I_D = 1.0mA$
$R_{DS(on)}$	Static Drain-to-Source On-State Resistance	—	—	19.5	m Ω	$V_{GS} = 12V, I_{D2} = 45A^1$
$V_{GS(th)}$	Gate Threshold Voltage	2.0	—	4.0	V	$V_{DS} \geq V_{GS}, I_D = 6mA$
$\Delta V_{GS(th)}/\Delta T_J$	Gate Threshold Voltage Coefficient	—	-8.5	—	mV/ $^\circ\text{C}$	
G_{fs}	Forward Transconductance	47	—	—	S	$V_{DS} = 15V, I_{D2} = 45A^1$
I_{DSS}	Zero Gate Voltage Drain Current	—	—	1.0	μA	$V_{DS} = 200V, V_{GS} = 0V$
		—	—	25		$V_{DS} = 200V, V_{GS} = 0V, T_J = 125^\circ\text{C}$
I_{GSS}	Gate-to-Source Leakage Forward	—	—	100	nA	$V_{GS} = 20V$
	Gate-to-Source Leakage Reverse	—	—	-100		$V_{GS} = -20V$
Q_G	Total Gate Charge	—	—	165	nC	$I_{D1} = 45A$
Q_{GS}	Gate-to-Source Charge	—	—	64		$V_{DS} = 125V$
Q_{GD}	Gate-to-Drain ('Miller') Charge	—	—	48		$V_{GS} = 12V$
$t_{d(on)}$	Turn-On Delay Time	—	—	41	ns	$I_{D1} = 45A^{**}$ $V_{DD} = 125V$ $R_G = 2.4\Omega$ $V_{GS} = 12V$
t_r	Rise Time	—	—	39		
$t_{d(off)}$	Turn-Off Delay Time	—	—	120		
t_f	Fall Time	—	—	57		
$L_s + L_D$	Total Inductance	—	6.8	—	nH	Measured from Drain lead (6mm / 0.25in from package) to Source lead (6mm / 0.25in from package) with Source wire internally bonded from Source pin to Drain pad
C_{iss}	Input Capacitance	—	8390	—	pF	$V_{GS} = 0V$ $V_{DS} = 25V$ $f = 100KHz$
C_{oss}	Output Capacitance	—	1200	—		
C_{rss}	Reverse Transfer Capacitance	—	1.0	—		
R_G	Gate Resistance	—	1.5	—	Ω	$f = 1.0MHz$, open drain

** Switching speed maximum limits are based on manufacturing test equipment and capability.

¹ Pulse width $\leq 300 \mu\text{s}$; Duty Cycle $\leq 2\%$

Device Characteristics

2.2 Source-Drain Diode Ratings and Characteristics (Pre-Irradiation)

Table 4 Source-Drain Diode Characteristics

Symbol	Parameter	Min.	Typ.	Max.	Unit	Test Conditions
I_S	Continuous Source Current (Body Diode)	—	—	45	A	
I_{SM}	Pulsed Source Current (Body Diode) ¹	—	—	180	A	
V_{SD}	Diode Forward Voltage	—	—	1.2	V	$T_J = 25^\circ\text{C}$, $I_S = 45\text{A}$, $V_{GS} = 0\text{V}$ ²
t_{rr}	Reverse Recovery Time	—	312	400	ns	$T_J = 25^\circ\text{C}$, $I_F = 45\text{A}$, $V_{DD} \leq 25\text{V}$ $di/dt = 100\text{A}/\mu\text{s}$ ²
Q_{rr}	Reverse Recovery Charge	—	5.1	—	μC	
t_{on}	Forward Turn-On Time	Intrinsic turn-on time is negligible (turn-on is dominated by $L_S + L_D$)				

2.3 Thermal Characteristics

Table 5 Thermal Resistance

Symbol	Parameter	Min.	Typ.	Max.	Unit
$R_{\theta JC}$	Junction-to-Case	—	—	0.6	$^\circ\text{C}/\text{W}$
$R_{\theta CS}$	Junction-to-Sink	—	0.21	—	
$R_{\theta JA}$	Junction-to-Ambient (Typical socket mount)	—	—	48	

2.4 Radiation Characteristics

IR HiRel radiation hardened MOSFETs are tested to verify their radiation hardness capability. The hardness assurance program at IR HiRel is comprised of two radiation environments. Every manufacturing lot is tested for total ionizing dose (per notes 3 and 4) using the TO-3 package. Both pre- and post-irradiation performance are tested and specified using the same drive circuitry and test conditions in order to provide a direct comparison.

2.4.1 Electrical Characteristics — Post Total Dose Irradiation

Table 6 Electrical Characteristics @ $T_J = 25^\circ\text{C}$, Post Total Dose Irradiation^{3, 4}

Symbol	Parameter	Up to 300 krad (Si) ⁵		Unit	Test Conditions
		Min.	Max.		
BV_{DSS}	Drain-to-Source Breakdown Voltage	250	—	V	$V_{GS} = 0\text{V}$, $I_D = 1.0\text{mA}$
$V_{GS(th)}$	Gate Threshold Voltage	2.0	4.0	V	$V_{DS} \geq V_{GS}$, $I_D = 6.0\text{mA}$
I_{GSS}	Gate-to-Source Leakage Forward	—	100	nA	$V_{GS} = 20\text{V}$
	Gate-to-Source Leakage Reverse	—	-100		$V_{GS} = -20\text{V}$
I_{DSS}	Zero Gate Voltage Drain Current	—	1.0	μA	$V_{DS} = 200\text{V}$, $V_{GS} = 0\text{V}$
$R_{DS(on)}$	Static Drain-to-Source On-State Resistance (TO-3) ²	—	18.5	m Ω	$V_{GS} = 12\text{V}$, $I_{D2} = 45\text{A}$
$R_{DS(on)}$	Static Drain-to-Source On-State Resistance (TO-254AA) ²	—	19.5	m Ω	$V_{GS} = 12\text{V}$, $I_{D2} = 45\text{A}$
V_{SD}	Diode Forward Voltage	—	1.2	V	$V_{GS} = 0\text{V}$, $I_F = 45\text{A}$

¹ Repetitive Rating; Pulse width limited by maximum junction temperature.

² Pulse width $\leq 300 \mu\text{s}$; Duty Cycle $\leq 2\%$

³ Total Dose Irradiation with V_{GS} Bias. $V_{GS} = 12\text{V}$ applied and $V_{DS} = 0$ during irradiation per MIL-STD-750, Method 1019, condition A.

⁴ Total Dose Irradiation with V_{DS} Bias. $V_{DS} = 200\text{V}$ applied and $V_{GS} = 0$ during irradiation per MIL-STD-750, Method 1019, condition A.

⁵ Part numbers IRHMS9A7264 and IRHMS9A3264

Device Characteristics

2.4.2 Single Event Effects — Safe Operating Area

IR HiRel radiation hardened MOSFETs have been characterized in heavy ion environment for Single Event Effects (SEE). Single Event Effects characterization is illustrated in Fig. 1 and Table 7.

Table 7 Typical Single Event Effects Safe Operating Area

LET (MeV·cm ² /mg)	Energy (MeV)	Range (μm)	V _{DS} (V)				
			V _{GS} = 0V	V _{GS} = -1V	V _{GS} = -3V	V _{GS} = -10V	V _{GS} = -15V
35.7 ± 5%	486 ± 7.5%	58.8 ± 7.5%	250	250	250	250	250
58.5 ± 5%	825 ± 7.5%	65.9 ± 7.5%	250	250	250	250	—
88.2 ± 5%	1685 ± 7.5%	92.7 ± 7.5%	200	200	—	—	—

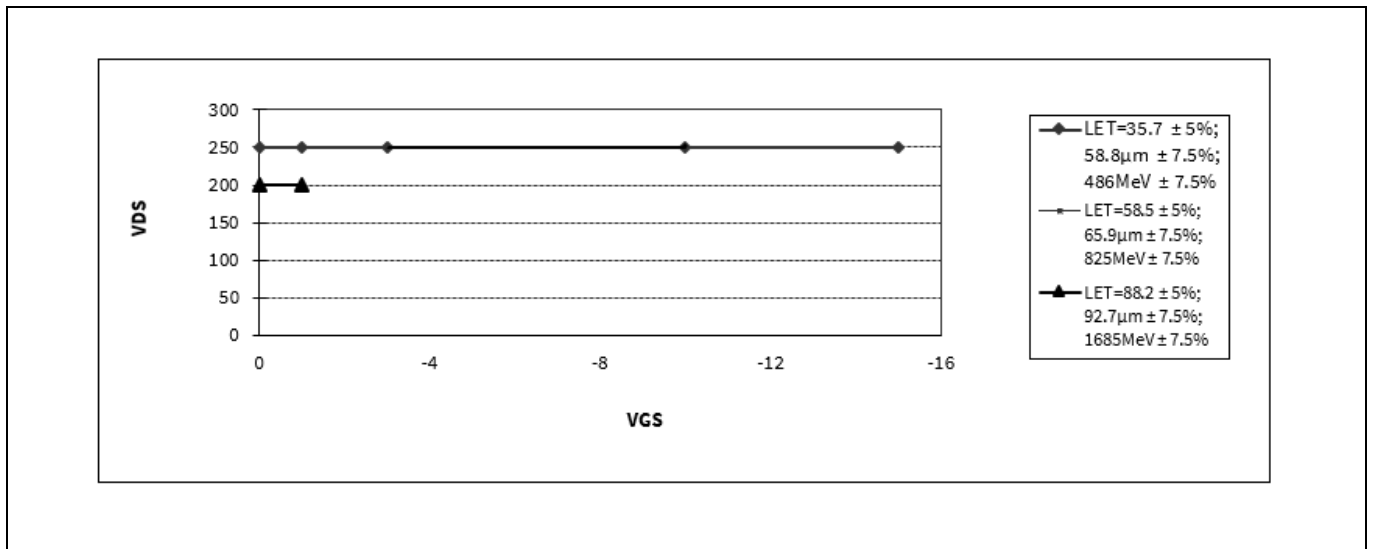

Figure 1 Typical Single Event Effect, Safe Operating Area

3 Electrical Characteristics Curves (Pre-irradiation)

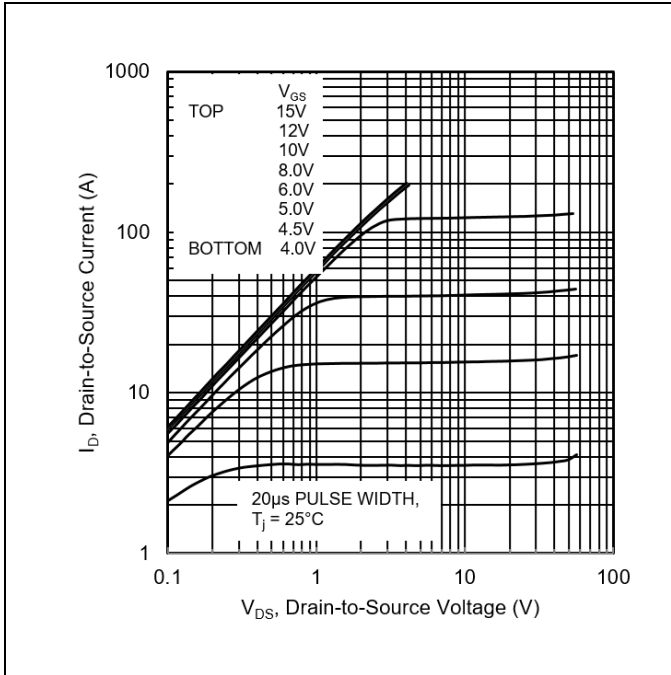

Figure 2 Typical Output Characteristics

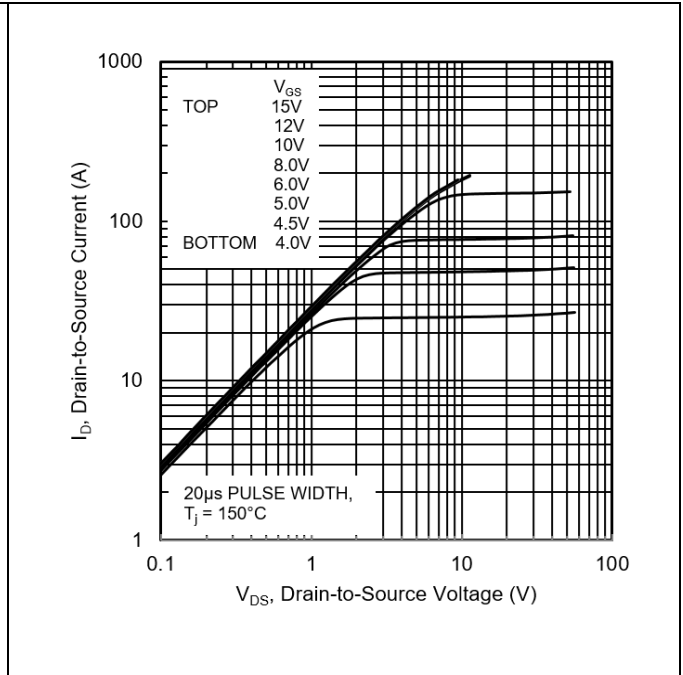

Figure 3 Typical Output Characteristics

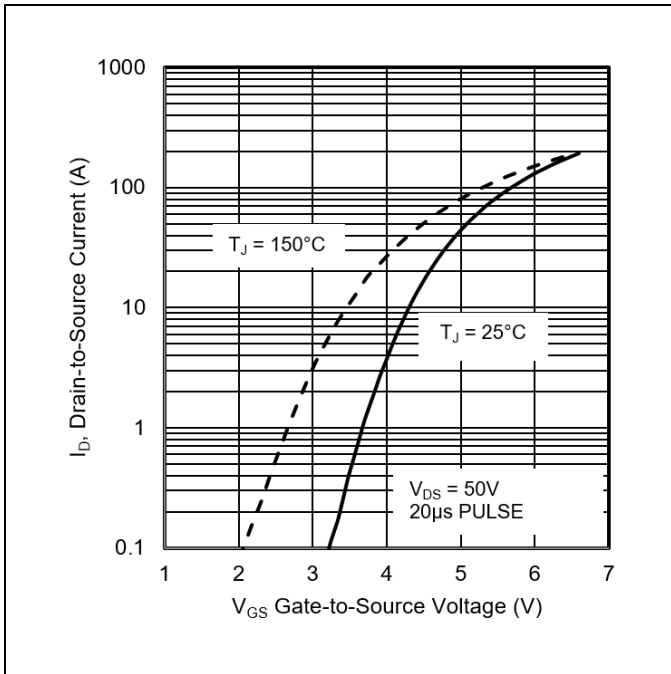

Figure 4 Typical Transfer Characteristics

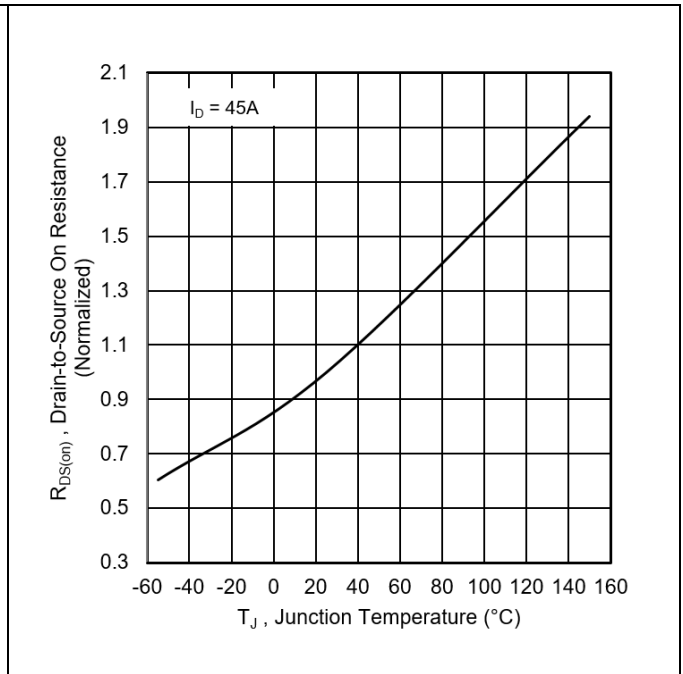

Figure 5 Normalized On-Resistance Vs. Temperature

IRHMS9A7264

Radiation Hardened Power MOSFET Thru-Hole (TO-254AA Low Ohmic)

Electrical Characteristics Curves (Pre-irradiation)

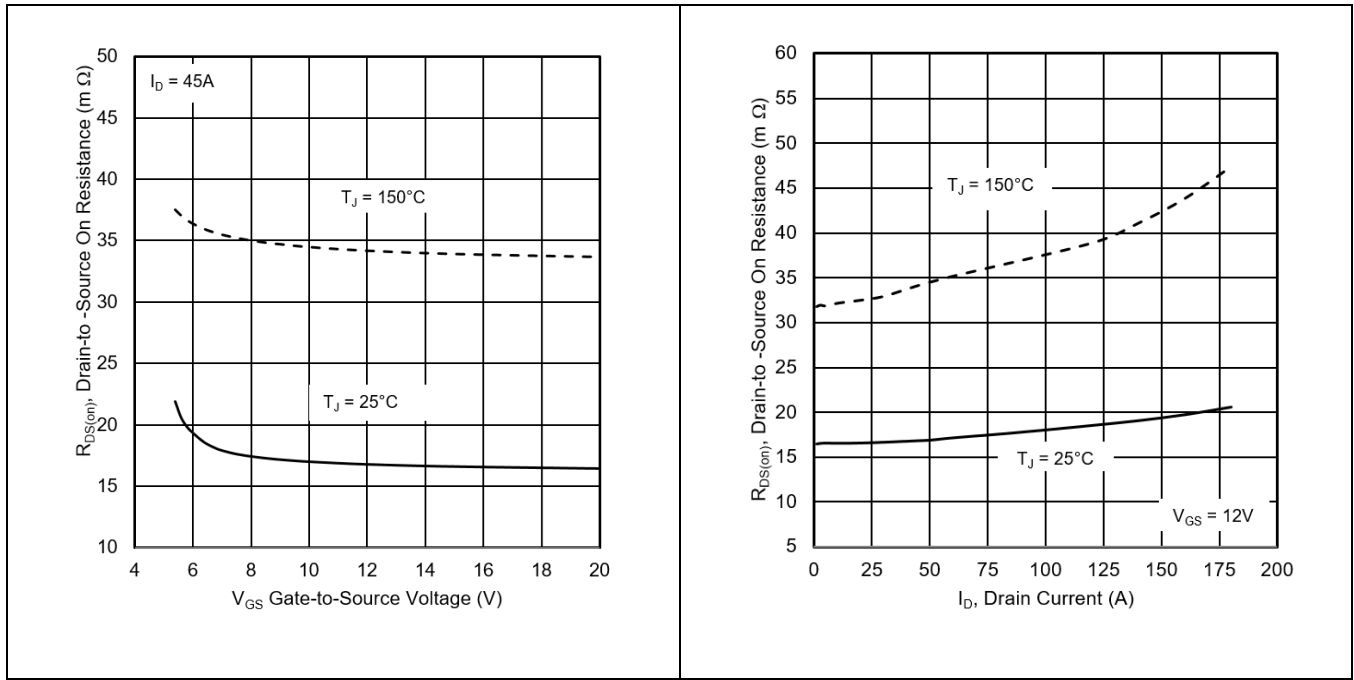

Figure 6 Typical On-Resistance Vs Gate Voltage **Figure 7 Typical On-Resistance Vs Drain Current**

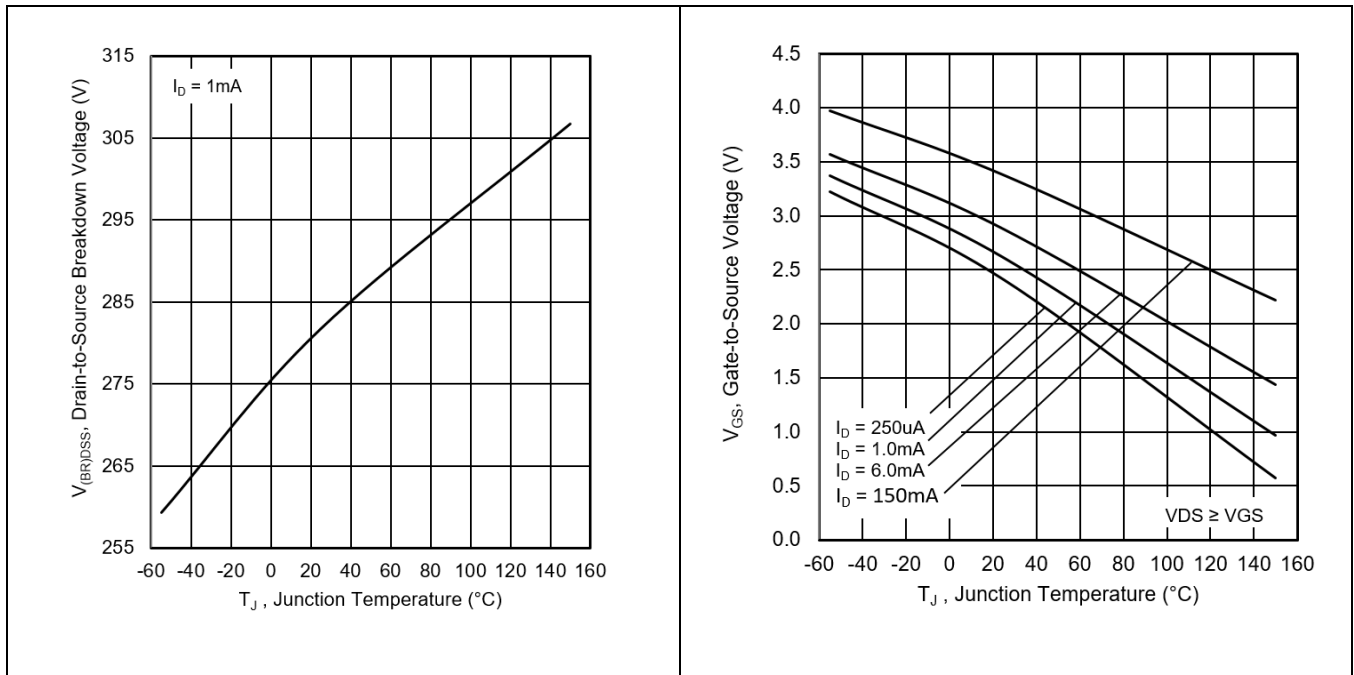

Figure 8 Typical Drain-to-Source Breakdown Voltage Vs. Temperature **Figure 9 Typical Threshold Voltage Vs. Temperature**

IRHMS9A7264

Radiation Hardened Power MOSFET Thru-Hole (TO-254AA Low Ohmic)

Electrical Characteristics Curves (Pre-irradiation)

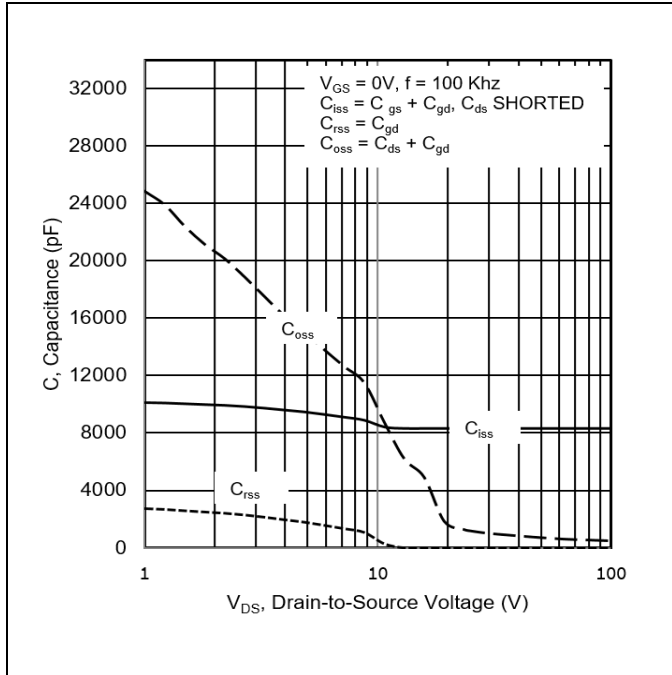

Figure 10 Typical Capacitance Vs. Drain-to-Source Voltage

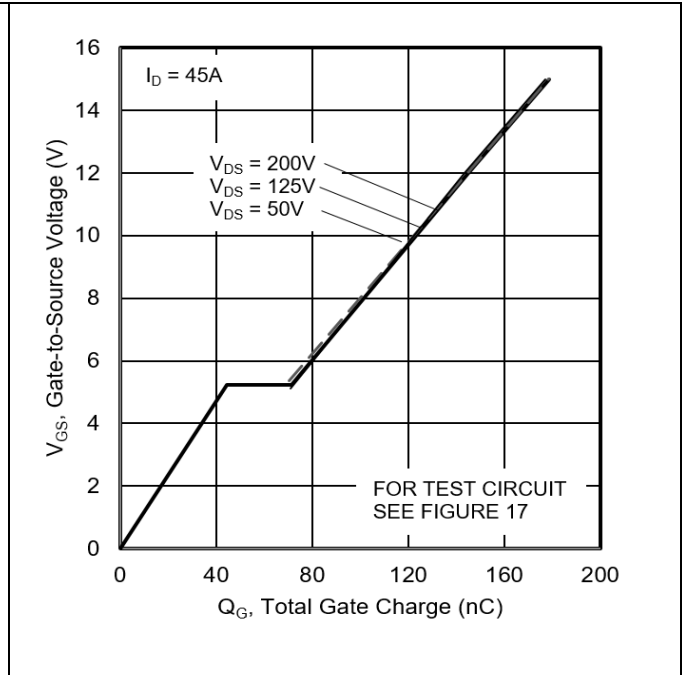

Figure 11 Gate-to-Source Voltage Vs. Typical Gate Charge

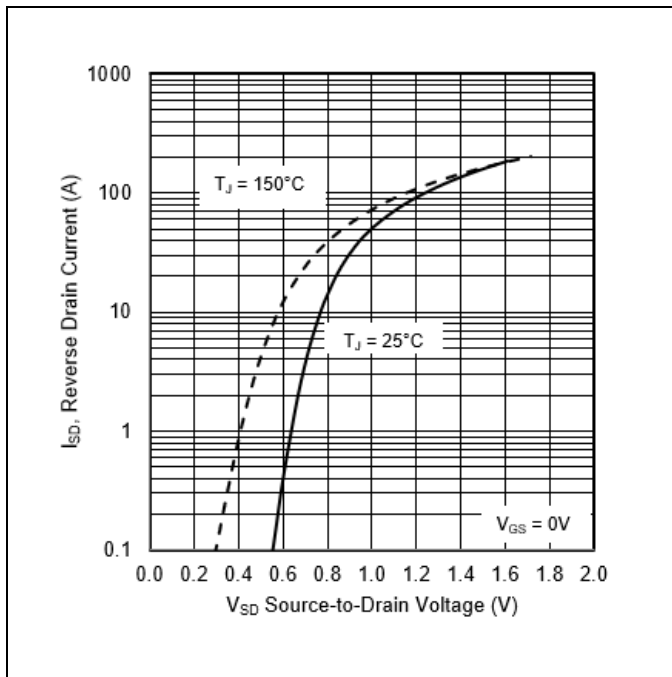

Figure 12 Typical Source-Drain Current Vs. Diode Forward Voltage

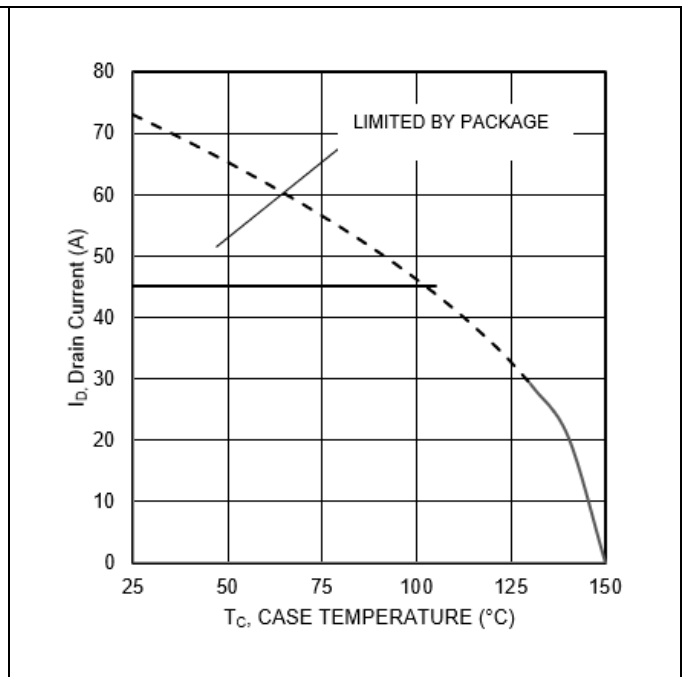

Figure 13 Maximum Drain Current Vs. Case Temperature

IRHMS9A7264

Radiation Hardened Power MOSFET Thru-Hole (TO-254AA Low Ohmic)

Electrical Characteristics Curves (Pre-irradiation)

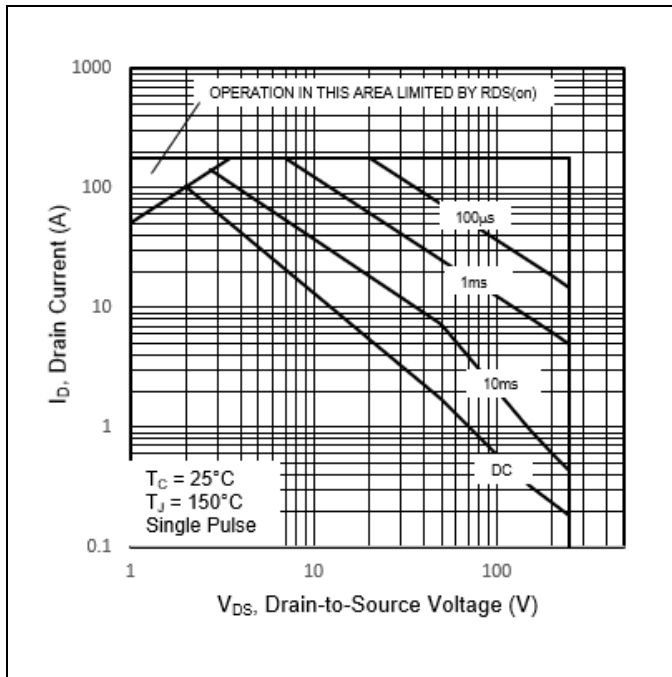

Figure 14 Maximum Safe Operating Area

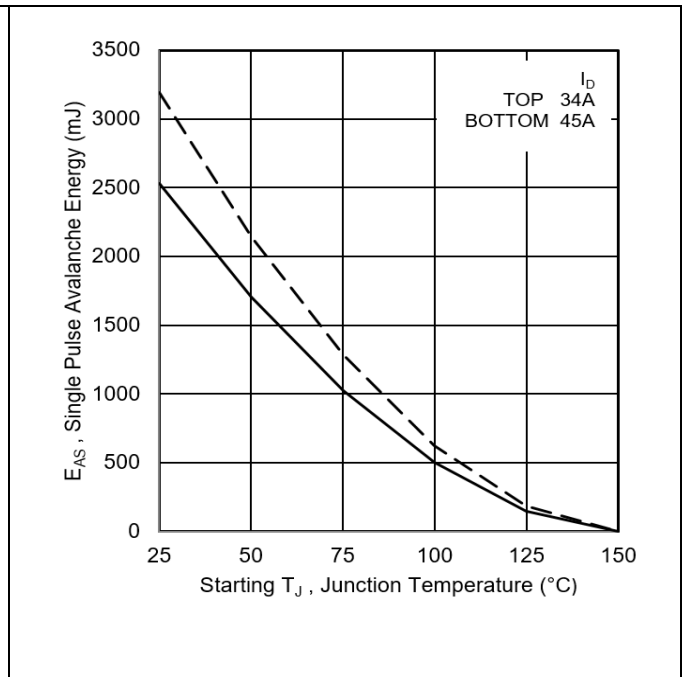

Figure 15 Maximum Avalanche Energy Vs. Junction Temperature

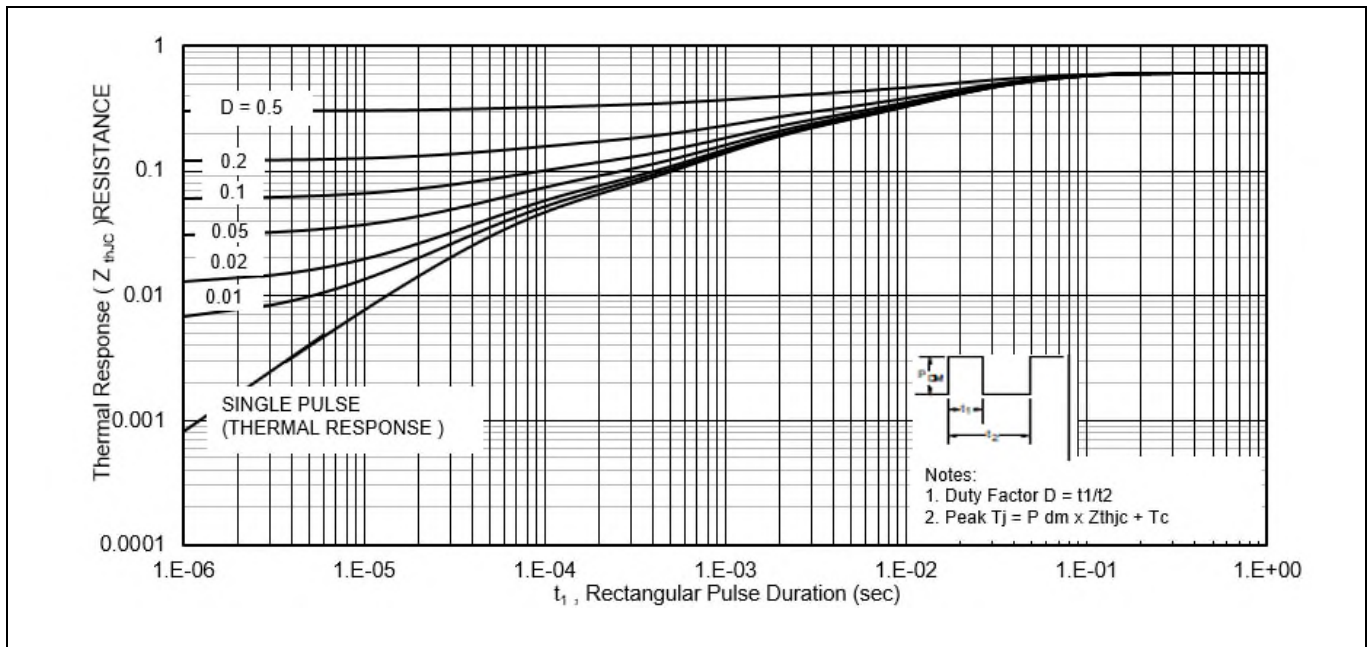

Figure 16 Maximum Effective Transient Thermal Impedance, Junction-to-Case

IRHMS9A7264

Radiation Hardened Power MOSFET Thru-Hole (TO-254AA Low Ohmic)

Test Circuits (Pre-irradiation)

4 Test Circuits (Pre-irradiation)

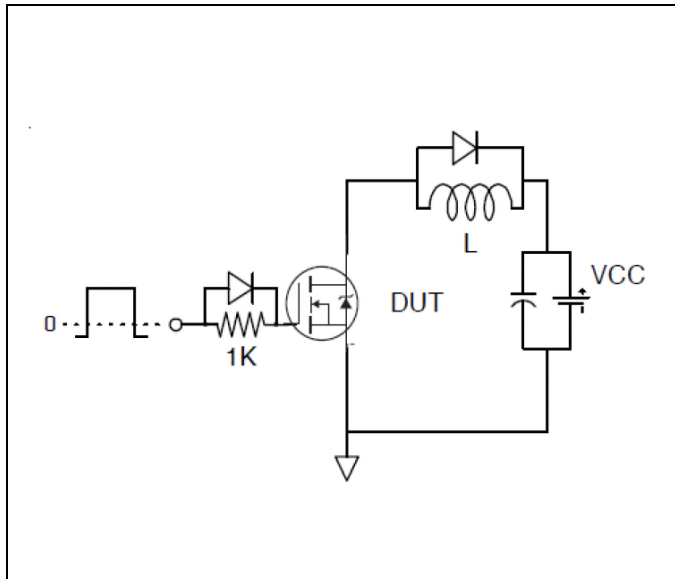

Figure 17 Gate Charge Test Circuit

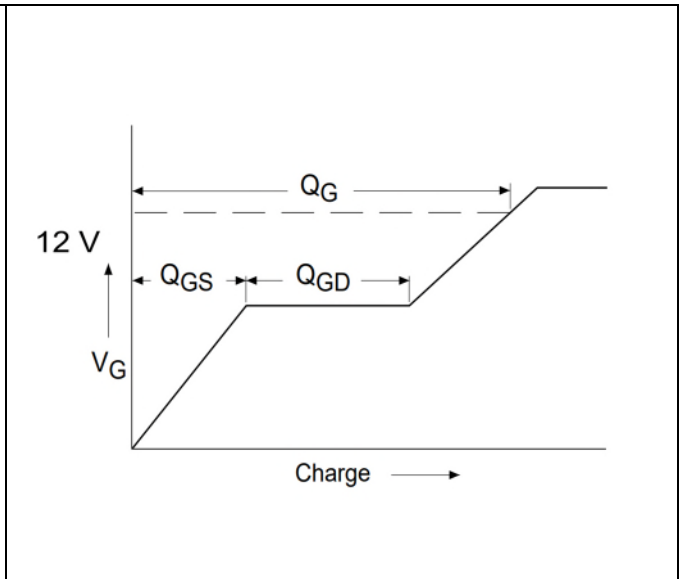

Figure 18 Gate Charge Waveform

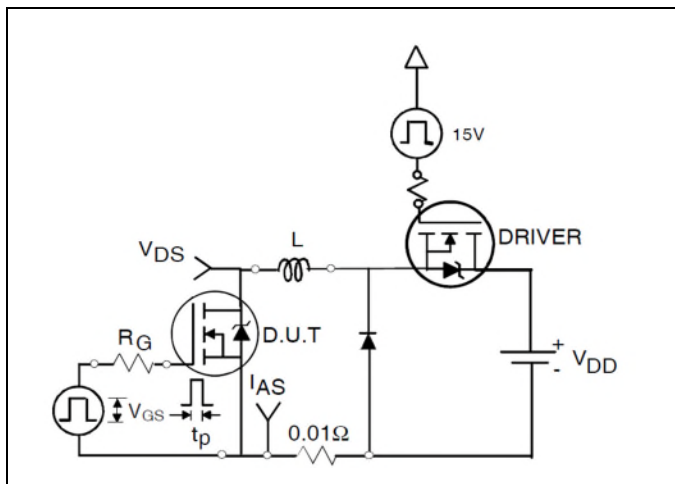

Figure 19 Unclamped Inductive Test Circuit

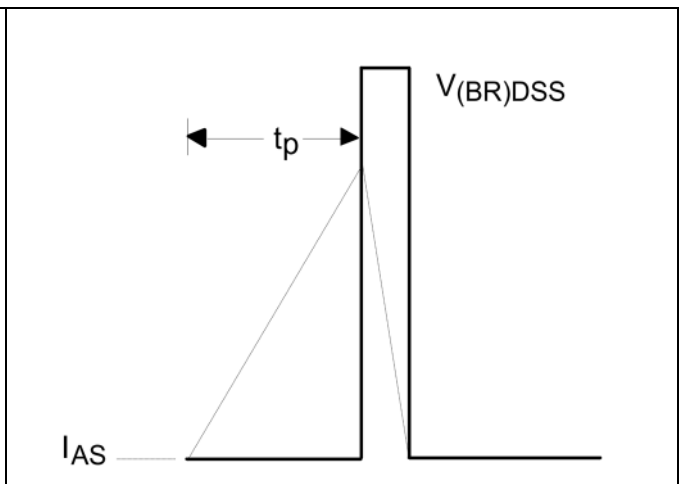

Figure 20 Unclamped Inductive Waveform

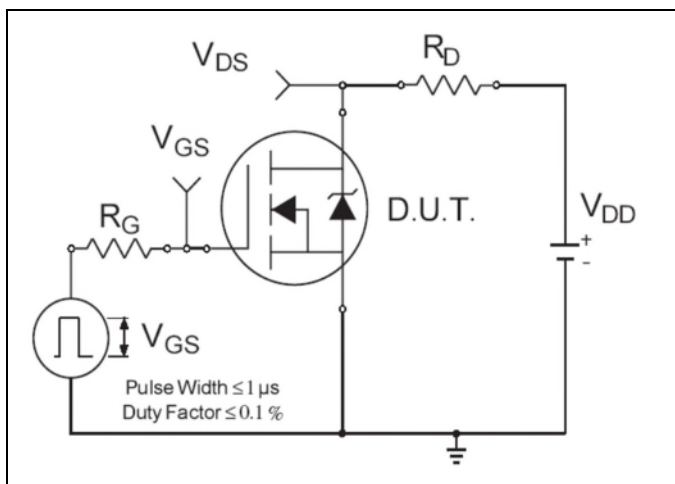

Figure 21 Switching Time Test Circuit

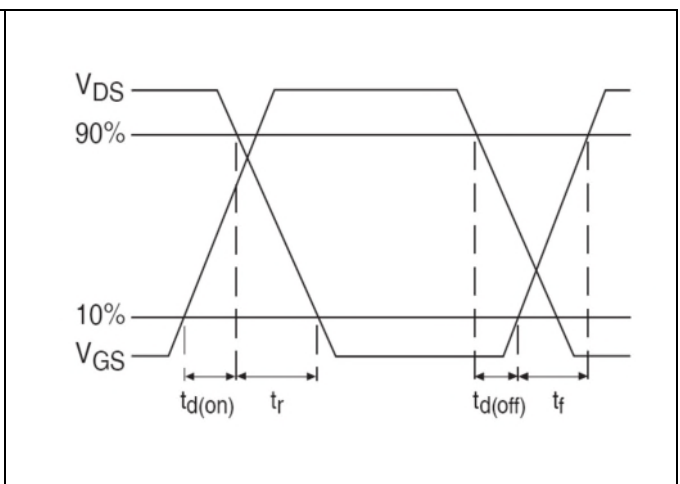
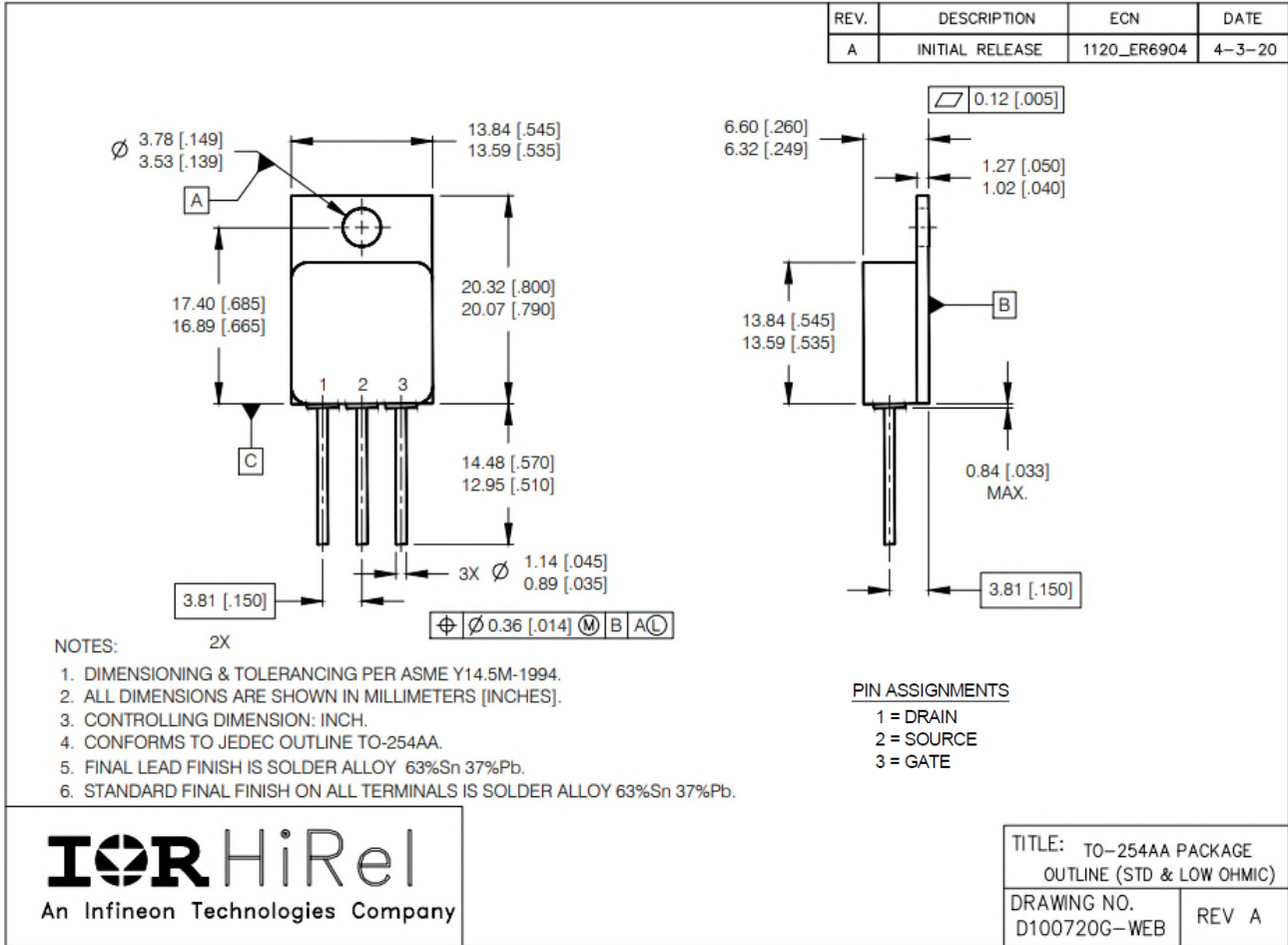

Figure 22 Switching Time Waveforms

Package Outline

5 Package Outline

Note: For the most updated package outline, please see the website: [TO-254AA Low Ohmic](#)



BERYLLIA WARNING PER MIL-PRF-19500

Package containing beryllia shall not be ground, sandblasted, machined, or have other operations performed on them which will produce beryllia or beryllium dust. Furthermore, beryllium oxide packages shall not be placed in acids that will produce fumes containing beryllium.

Revision history

Document version	Date of release	Description of changes
	08/25/2022	Preliminary datasheet with PPD number (PPD-97959A)
Rev B	10/31/2022	Final datasheet with PD number (PD-97959B)

Trademarks

All referenced product or service names and trademarks are the property of their respective owners.

Edition 2022-10-31

Published by

**International Rectifier HiRel Products,
Inc.**

**An Infineon Technologies company
El Segundo, California 90245 USA**

**© 2022 Infineon Technologies AG.
All Rights Reserved.**

**Do you have a question about this
document?**

Email: erratum@infineon.com

Document reference

IMPORTANT NOTICE

The information given in this document shall in no event be regarded as a guarantee of conditions or characteristics ("Beschaffheitsgarantie").

With respect to any examples, hints or any typical values stated herein and/or any information regarding the application of the product, Infineon Technologies hereby disclaims any and all warranties and liabilities of any kind, including without limitation warranties of non-infringement of intellectual property rights of any third party.

In addition, any information given in this document is subject to customer's compliance with its obligations stated in this document and any applicable legal requirements, norms and standards concerning customer's products and any use of the product of Infineon Technologies in customer's applications.

The data contained in this document is exclusively intended for technically trained staff. It is the responsibility of customer's technical departments to evaluate the suitability of the product for the intended application and the completeness of the product information given in this document with respect to such application.

For further information on the product, technology, delivery terms and conditions and prices please contact your nearest Infineon Technologies office (www.infineon.com).

WARNINGS

Due to technical requirements components may contain dangerous substances. For information on the types in question please contact your nearest International Rectifier HiRel Products, Inc., an Infineon Technologies company, office.

International Rectifier HiRel Components may only be used in life-support devices or systems with the expressed written approval of International Rectifier HiRel Products, Inc., an Infineon Technologies company, if failure of such components can reasonably be expected to cause the failure of that life-support device or system, or to affect the safety and effectiveness of that device or system.

Life support devices or systems are intended to be implanted in the human body, or to support and/or maintain and sustain and/or protect human life. If they fail, it is reasonable to assume that the health of the user or other persons may be endangered.