

Features

- High surge current capability
- Stud cathode and stud anode version
- Leaded version available
- Types up to 1600V V_{RRM}
- RoHS Compliant

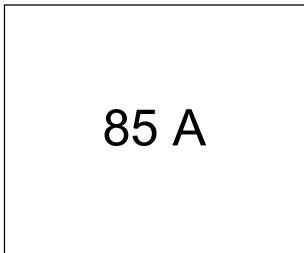

Typical Applications

- Battery charges
- Converters
- Power supplies
- Machine tool controls
- Welding

Major Ratings and Characteristics

Parameters	85HF(R)		Units	
	10 to 120	140 , 160		
$I_{F(AV)}$	85	85	A	
	@ T_C	140	110	
$I_{F(RMS)}$	133		A	
I_{FSM}	@ 50Hz	1700	A	
	@ 60Hz	1800	A	
I^2t	@ 50Hz	14500	A ² s	
	@ 60Hz	13500	A ² s	
V_{RRM}	range	100 to 1200	1400 , 1600	V
T_J	range	- 65 to 180	- 65 to 150	°C



ELECTRICAL SPECIFICATIONS

Voltage Ratings

Type number	Voltage Code	V_{RRM} , maximum repetitive peak reverse voltage V	V_{RSM} , maximum non-repetitive peak reverse voltage V	I_{RRM} max. @ $T_J = T_J$ max. mA
85HF(R)	10	100	200	9
	20	200	300	
	40	400	500	
	60	600	700	
	80	800	900	
	100	1000	1100	
	120	1200	1300	
	140	1400	1500	
	160	1600	1700	4.5

Forward Conduction

Parameter	85HF(R)		Units	Conditions		
	10 to 120	140, 160				
$I_{F(AV)}$ Max. average forward current @ Case temperature	85	85	A	180° conduction, half sine wave		
	140	110	°C			
$I_{F(RMS)}$ Max. RMS forward current	133		A			
I_{FSM} Max. peak, one-cycle forward, non-repetitive surge current	1700		A	t = 10ms	No voltage	Sinusoidal half wave, Initial $T_J = T_J$ max.
	1800			t = 8.3ms	reapplied	
	1450			t = 10ms	100% V_{RRM}	
	1500			t = 8.3ms	reapplied	
I^2t Maximum I^2t for fusing	14500		A^2s	t = 10ms	No voltage	
	13500			t = 8.3ms	reapplied	
	10500			t = 10ms	100% V_{RRM}	
	9400			t = 8.3ms	reapplied	
$I^2\sqrt{t}$ Maximum $I^2\sqrt{t}$ for fusing	16000		$A^2\sqrt{s}$	t = 0.1 to 10ms, no voltage reapplied		
$V_{F(TO)}$ Value of threshold voltage (up to 1200V)	0.68		V	$T_J = T_J$ max.		
$V_{F(TO)}$ Value of threshold voltage (for 1400V, 1600V)	0.69			$T_J = T_J$ max.		
r_f Value of forward slope resistance (up to 1200V)	1.62		$m\Omega$	$T_J = T_J$ max.		
r_f Value of forward slope resistance (up to 1200V)	1.75			$T_J = T_J$ max.		
V_{FM} Max. forward voltage drop	1.2	1.4	V	$I_{pk} = 267A, T_J = 25^\circ C, t_p = 400\mu s$ rectangular wave		

Thermal and Mechanical Specifications

Parameter	85HF(R)		Units	Conditions
	10 to 120	140 to 160		
T _J Max. junction operating temperature range	-65 to 180	-65 to 150	°C	
T _{stg} Max. storage temperature range	-65 to 180	-65 to 150		
R _{thJC} Max. thermal resistance, junction to case	0.35		K/W	DC operation
R _{thCS} Max. thermal resistance, case to heatsink	0.25			Mounting surface, smooth, flat and greased
Maximum shock	1500g			see note (1)
Maximum constant vibration	20g		50Hz	see note (1)
Maximum constant acceleration	5000g		Stud outwards	see note (1)
T Allowable mounting torque	3.4 ^{+0-10%}		Nm	Not lubricated threads
	30		lbf · in	
	2.3 ^{+0-10%}		Nm	Lubricated threads
	20		lbf · in	
wt Approximate weight	17 (0.6)		g (oz)	unleaded device
Case style	DO-203AB (DO5)			See Outline Table

(1) Available only for 88HF

ΔR_{thJC} Conduction

(The following table shows the increment of thermal resistance R_{thJC} when devices operate at different conduction angles than DC)

Conduction angle	Sinusoidal conduction	Rectangular conduction	Units	Conditions
180°	0.10	0.08	K/W	T _J = T _J max.
120°	0.11	0.11		
90°	0.13	0.13		
60°	0.17	0.17		
30°	0.26	0.26		

Ordering Information Table

Device Code

85	HF	R	160	M
①	②	③	④	⑤

- 1** - 85 = Standard device
 86 = Not isolated lead
 87 = Isolated lead with silicone sleeve
 (Red = Reverse polarity)
 (Blue = Normal polarity)
 88 = Type for rotating application
- 2** - Standard diode
- 3** - None = Stud Normal Polarity (Cathode to Stud)
 R = Stud Reverse Polarity (Anode to Stud)
- 4** - Voltage code: Code x 10 = V_{RRM} (See Voltage Ratings table)
- 5** - None = Stud base DO-203AB (DO-5) 1/4" 28UNF-2A
 M = Stud base DO-203AB (DO-5) M6 X 1 - (Not available for 88HF)

Outlines Table

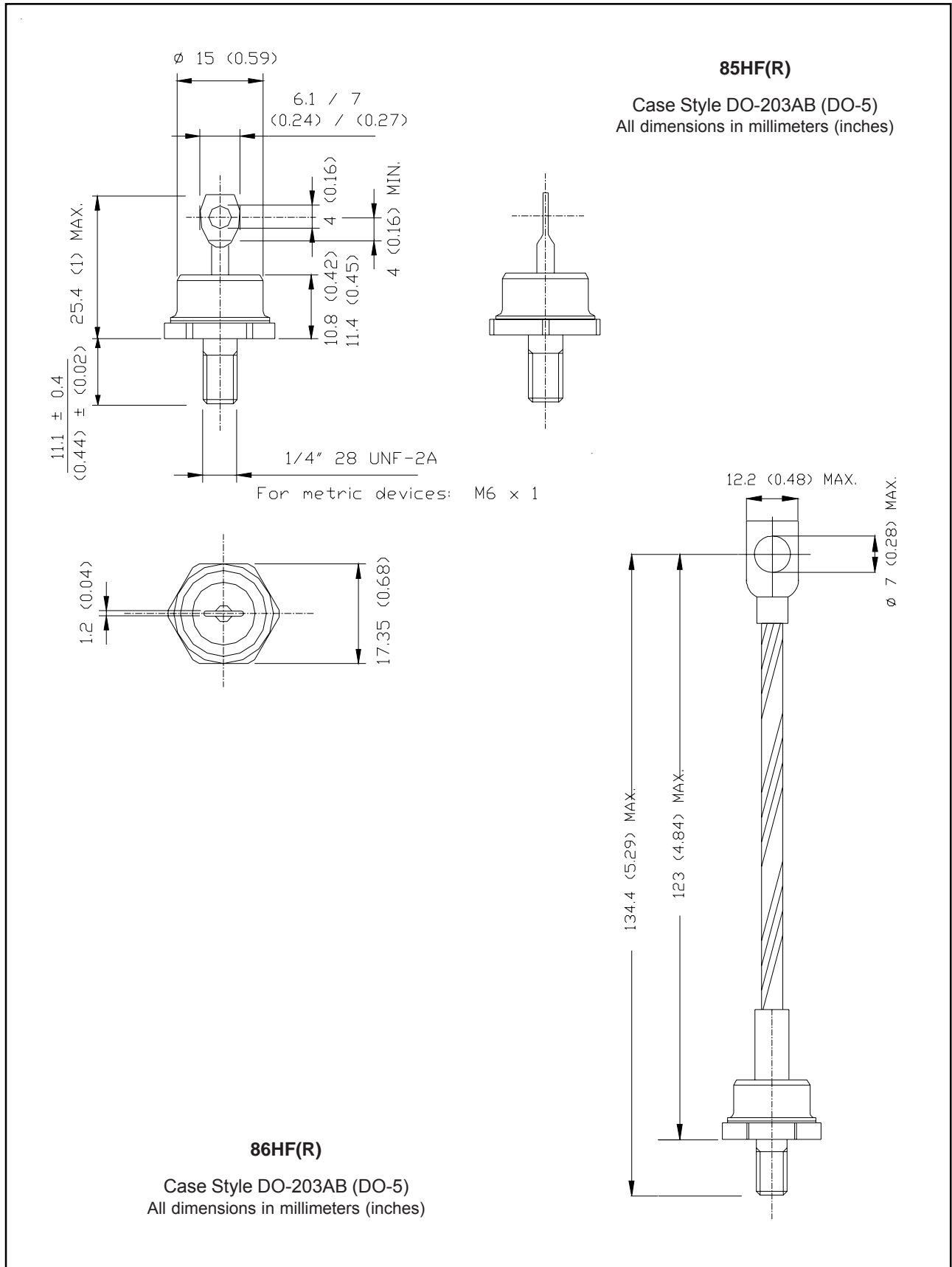

Outlines Table

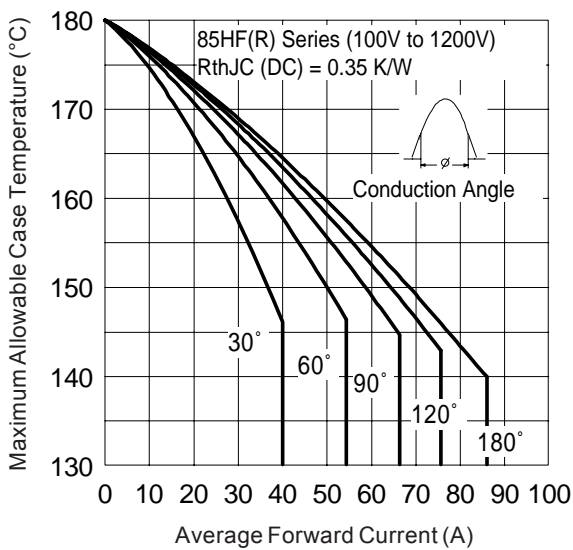
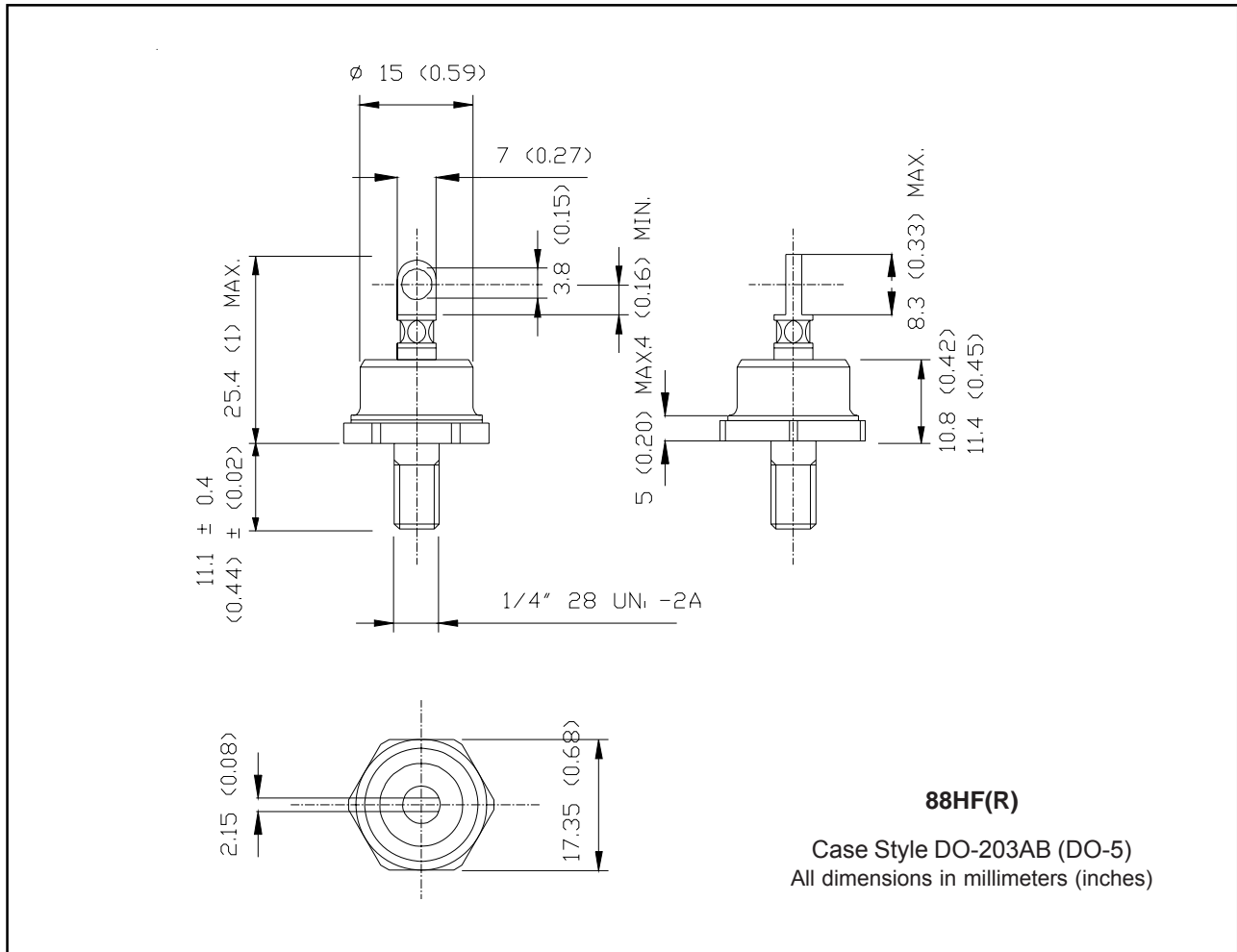

Fig. 1 - Current Ratings Characteristics

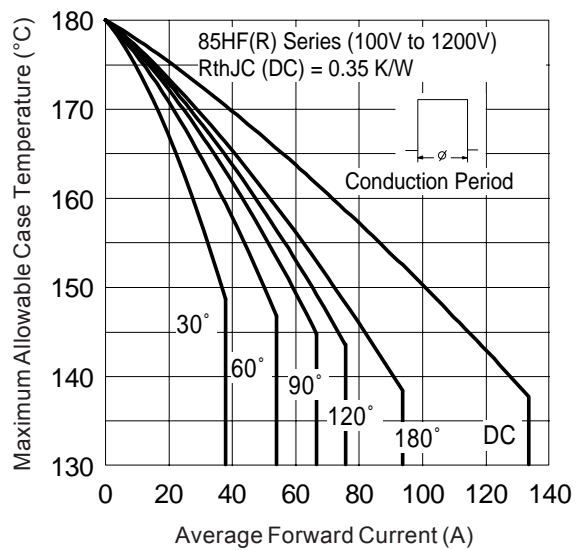

Fig. 2 - Current Ratings Characteristics

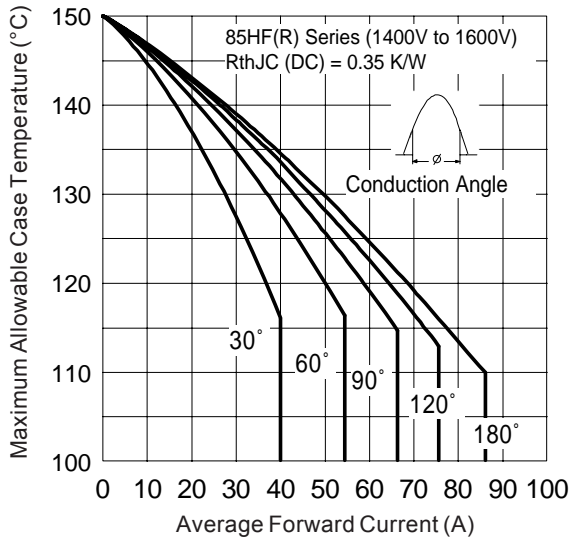

Fig. 3 - Current Ratings Characteristics

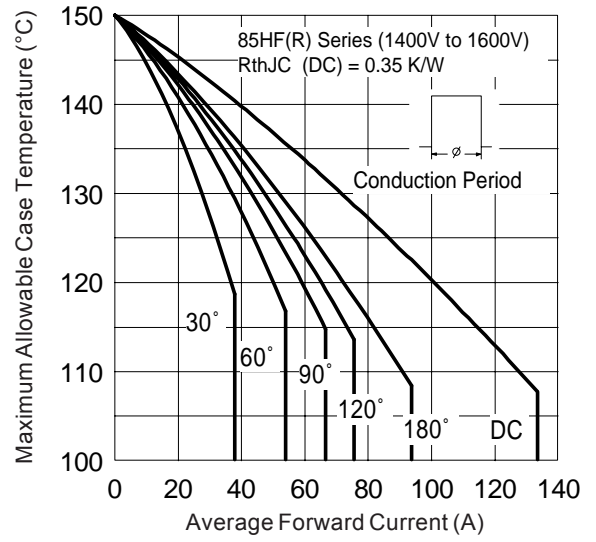

Fig. 4 - Current Ratings Characteristics

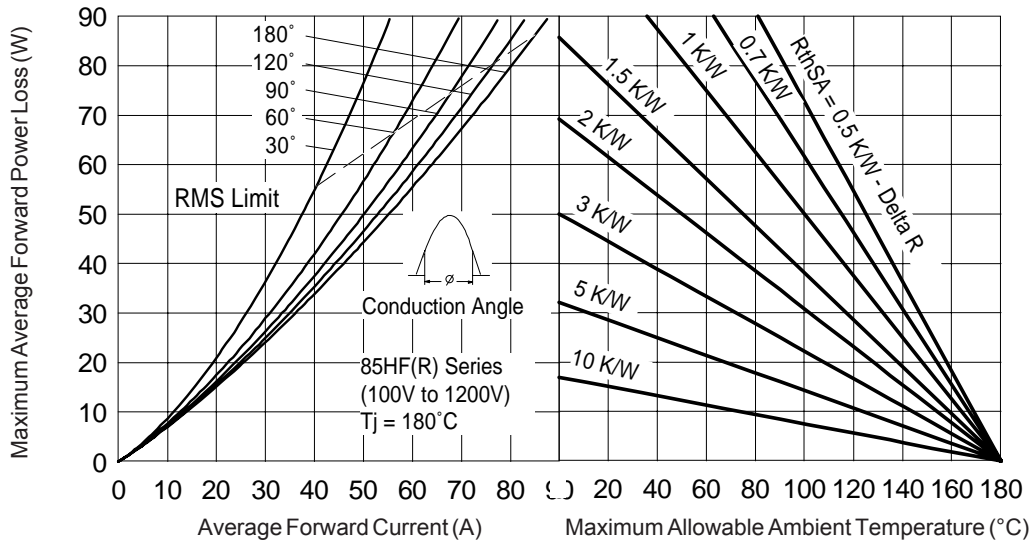

Fig. 5 - Forward Power Loss Characteristics

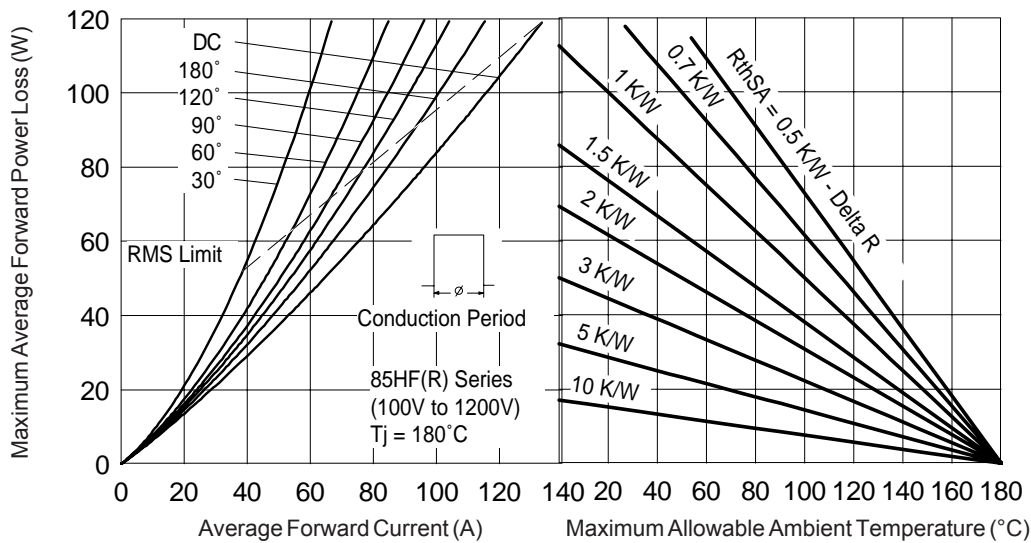

Fig. 6 - Forward Power Loss Characteristics

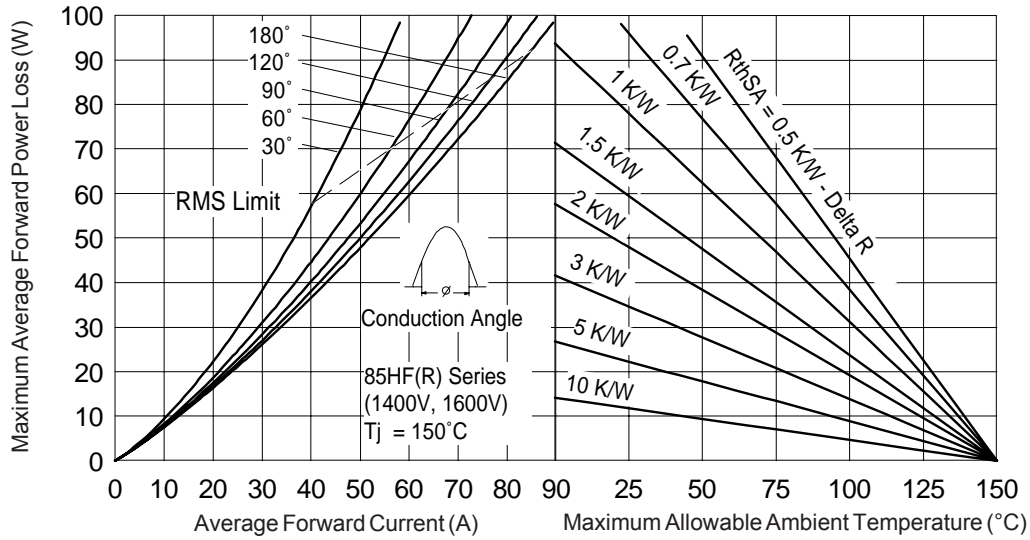

Fig. 7 - Forward Power Loss Characteristics

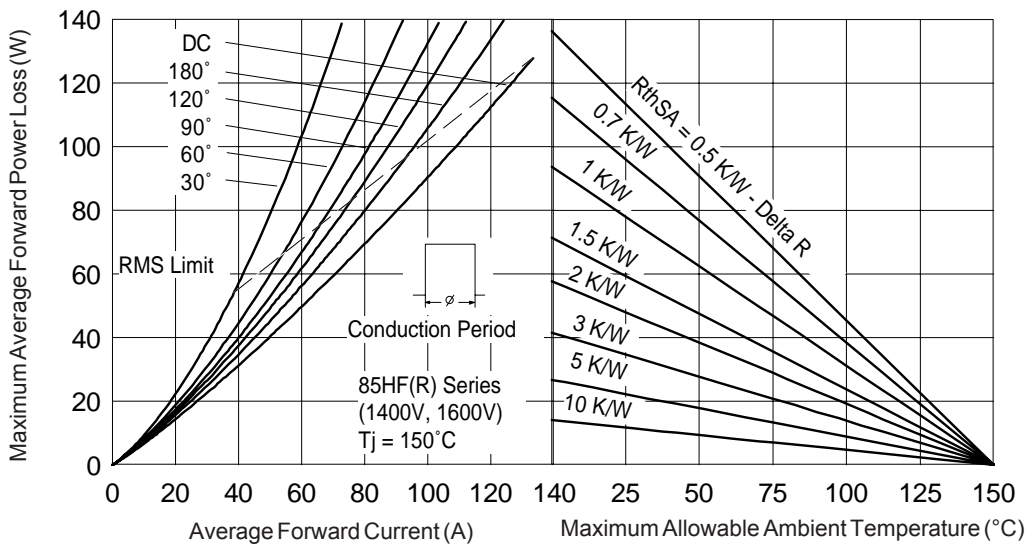

Fig. 8 - Forward Power Loss Characteristics

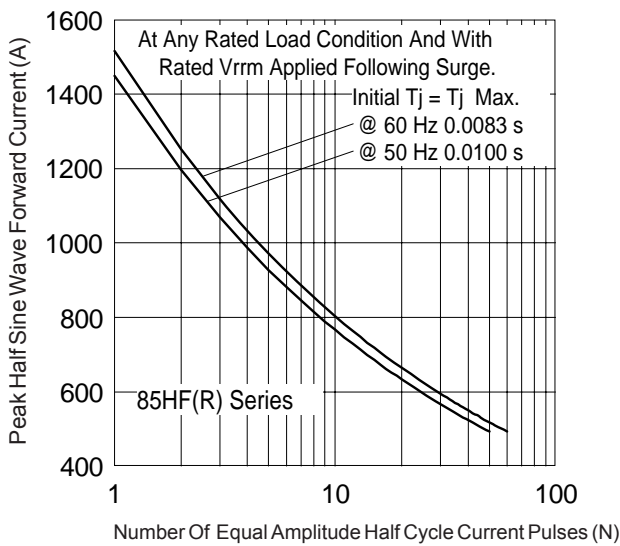

Fig. 9 - Maximum Non-Repetitive Surge Current

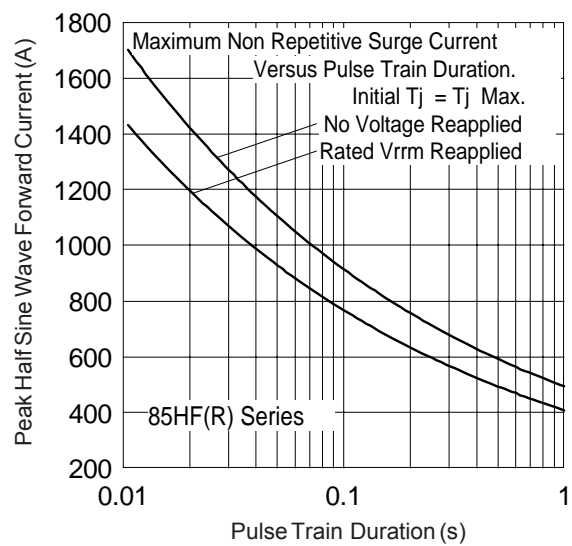

Fig. 10 - Maximum Non-Repetitive Surge Current

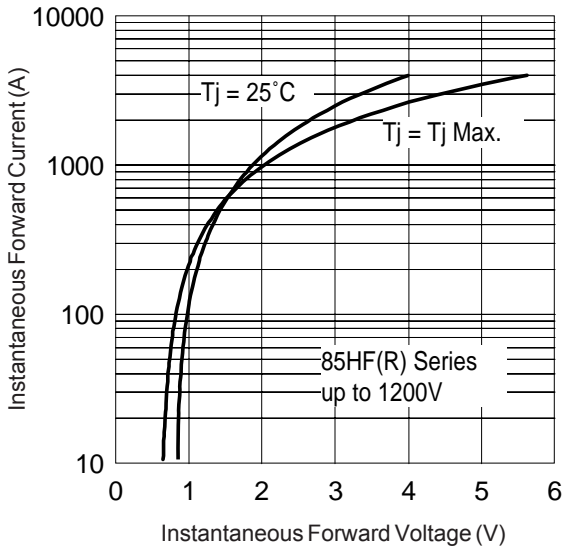

Fig. 11 - Forward Voltage Drop Characteristics (up to 1200V)

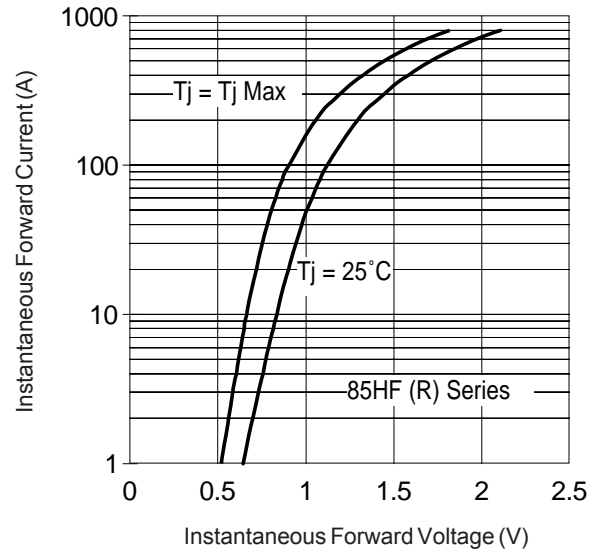

Fig. 12 - Forward Voltage Drop Characteristics (for 1400V, 1600V)

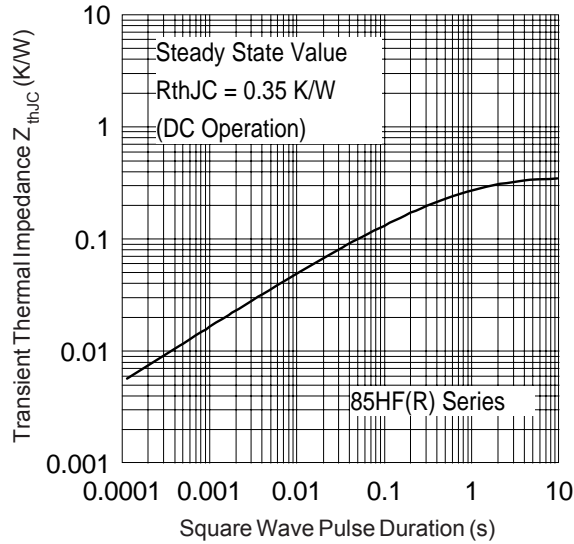

Fig. 13 - Thermal Impedance Z_{thJC} Characteristics

Data and specifications subject to change without notice.
This product has been designed and qualified for Industrial Level.
Qualification Standards can be found on IR's Web site.