



IRUH3301 Voltage Regulator

**Enhanced Low Dose Rate Sensitivity
Test Report**

July 2010

International Rectifier currently does not have a DSCC approved Radiation Hardness Assurance Program for MIL-PRF-38534.

Table of Contents

Introduction	3
Summary of Results	3
Test Method	3
Test Plan	3
Test Facility	4
Test Results	5
Conclusion	10
Appendix A – Electrical Data	
Appendix B – Radiation Test Specification	

INTRODUCTION

This test report covers the low dose rate tests performed on the IRUH3301 Low Dropout linear regulator product line in a hermetic package. Since all part numbers within the IRUH3301 product line contain the same active components, performance under radiation will be the same. The test was performed on ten samples from production lot H916391, which had completed MIL-PRF-38534 “K” level assembly and screening. On March 22, 2010 International Rectifier completed low dose testing at the University of Massachusetts, Nuclear Research Facility using their CO⁶⁰ source.

SUMMARY OF RESULTS

All of the test samples passed the post radiation test requirements for total ionizing dose levels up to 100K RAD(Si). The results show no significant degradation for either of the bias conditions used during the irradiation for any of the parameters measured and no significant difference to the High Dose Rate results measured on October 28, 2009.

TEST METHOD

The test method used as a guide in the development of the Test Plan was MIL-STD-883, Method 1019 Ionizing Radiation per Condition D. This method establishes the basic requirements for the performance and execution of the tests.

TEST PLAN

The samples were exposed to CO⁶⁰ irradiation in both an “ON” and “OFF” biased state per the requirements of the test plan and the radiation test specification. Post radiation testing of the devices occurred at the UMass facility after each dose step was complete. The devices were tested between October 28, 2009 and March 22, 2010 at ≤ 10 mRad(Si) per second. The samples were removed from the radiation chamber four times to collect post radiation test results.

ON Biased serial numbers: 68, 81, 76, 84, 59 (outputs fixed at 2.4V with 6.8V in and 10mA load)
OFF Biased serial numbers: 27, 88, 60, 5, 44 (in circuit with power off)
Control Sample: 31 (not subjected to radiation or bias)

The Radiation Test Specification is included in Appendix B. The testing occurred in the following manner:

1.0 Purpose

The purpose of this test is to characterize and qualify the Total Ionizing Dose effects for International Rectifier’s hybrid low dropout regulator devices. The data resulting from the tests may be incorporated in the IR data sheet for the product.

2.0 Test Responsibility

International Rectifier shall be responsible for conducting the tests, which shall be performed at the University of Massachusetts Research Reactor facility. International Rectifier shall be responsible for the final Test Report.

3.0 Test Facility

3.1 Nuclear Reactor

The University of Massachusetts Research Reactor shall be used to provide the source for Gamma radiation. UMRR will also provide information on dose rate, total dose, irradiation test times and dosimetry for this evaluation.

3.2 Test Equipment

The necessary test equipment including interface board, cables, power supplies, measurement system, etc. shall be provided by International Rectifier.

3.3 Sample Size

Sample size shall be determined based on device type, characterization parameters. As a minimum, the sample size shall meet the requirements of Mil-PRF-38534. Sample size for this ELDRS evaluation equals 11 devices. Five of the samples shall be biased with the worst-case input voltage of 6.8 volts with the output fixed at 2.4V under a load of 10mA and five samples shall be biased "in-circuit" with the power supply turned off. One sample shall be maintained as control and shall be tested at each dose step.

4.0 Test Devices

4.1 The following device is planned for Total Ionizing Dose characterization:

- a. IRUH3301A2AK

4.2 All devices shall be tested after each radiation exposure per T090176G within 1 hour and placed back on to radiation exposure within 2 hours.

5.0 Test Method

MIL-STD-883, Method 1019 Condition D shall be used to establish the procedure for all testing described herein.

6.0 Record Keeping

The Reactor facility shall provide dosimetry data for the CO⁶⁰ source. Each exposure run shall be cataloged with the appropriate number in order to maintain correlation to the appropriate data set. IR will be responsible for collecting and compiling the test data.

7.0 Test Report

The Test Report shall include the following information:

- a. Device type(s), serial numbers, wafer lot identification (per active component)
- b. Test dates
- c. Facility, source type
- d. Bias conditions
- e. Comments and observations
- f. Pre and Post Electrical data
- g. Summary descriptive including graphs (When Applicable)

TEST FACILITY

The University of Massachusetts, Lowell, Nuclear Research Reactor is a 1 Mega-Watt, Uranium²³⁵ enhanced core reactor. The UMass Lowell Radiation Laboratory provides controlled radiation environments and analytical measurement services to government organizations and to industry. The laboratory provides facilities for proton, neutron, and gamma environments. The Gamma Cave is an irradiation room inside this facility having an equi-dimensional volume of 512

cubic feet. A wide range of dose rates, 1Gray (100 rad) per hour to 10,000 Gray (1 Mrad) per hour, is available. Several small ports penetrate one shielding wall to provide access for instrumentation cables.

Test Results

The raw test data for all the parameters tested is shown in Appendix A. As outlined in the Test Plan, five of the devices exposed to low dose irradiation were biased “ON” with the maximum input voltage and five samples were placed in the bias circuit with the power supply off or biased “OFF”.

The results for the Dropout Voltage parameter show wide fluctuations on both the control and test samples throughout the various test steps. Based on this the test results for this parameter are considered to be a functional result rather than a precise result. All samples passed the post radiation test requirements after exposure up to 100K Rad(Si).

The percent change of the Output Voltage parameter test results versus radiation are shown in graphical format Figures 1 thru 4. The Output Voltage did not change by more than $\pm 0.5\%$ up to 100K Rad(Si) exposure.

Figure 1

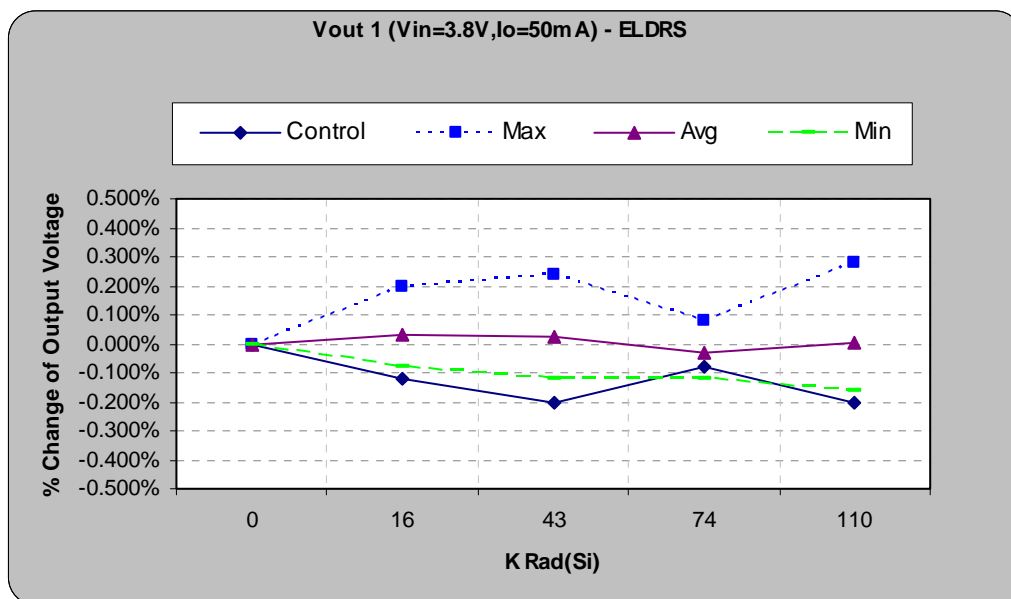

Figure 2

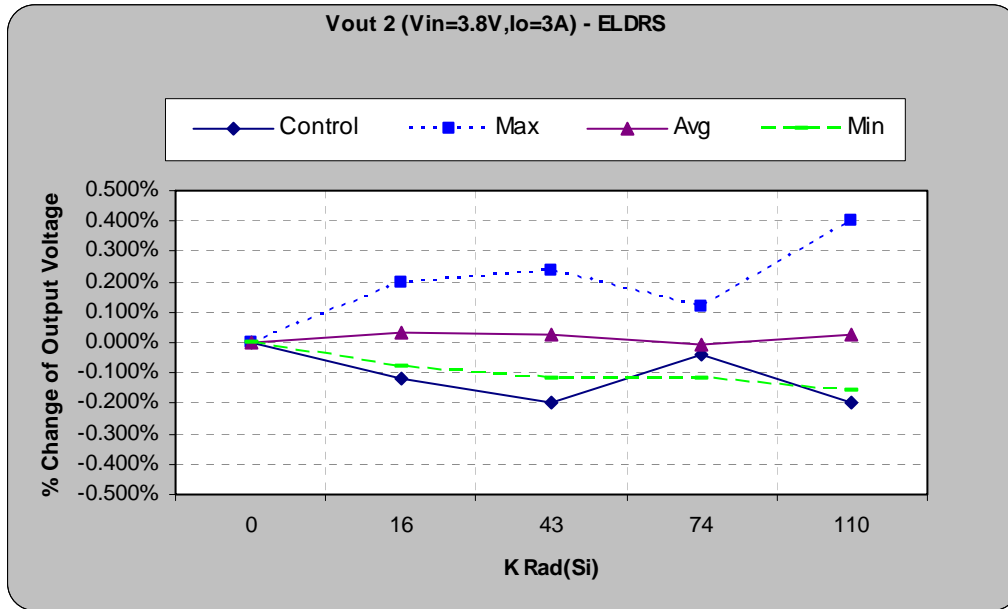

Figure 3

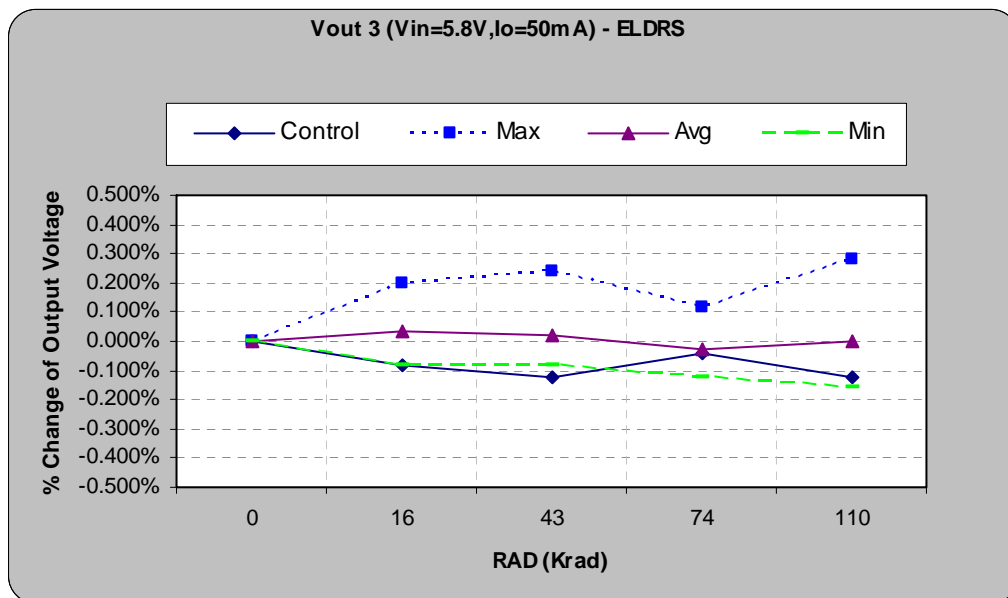
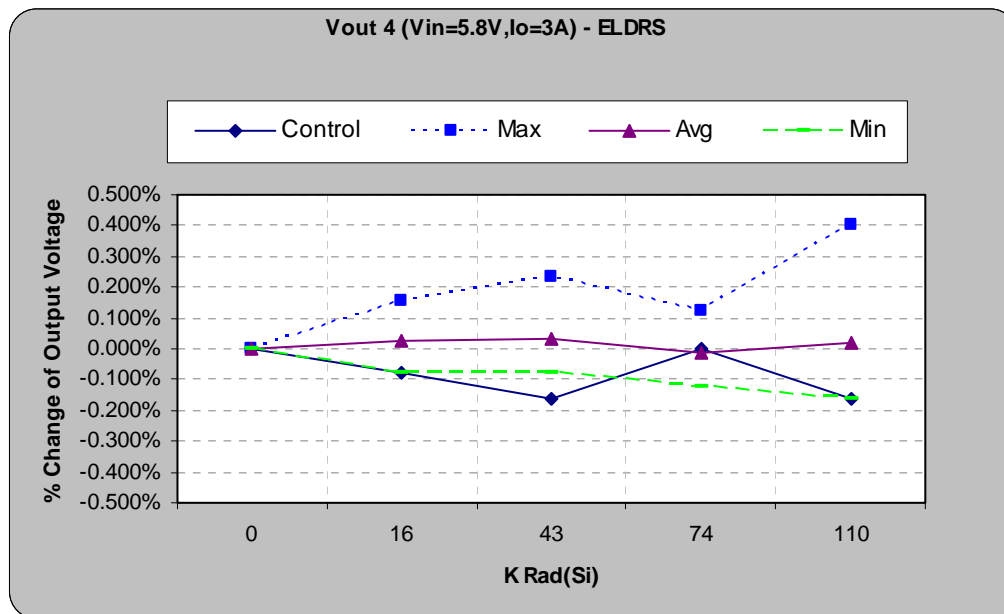

Figure 4



Comparison of ELDRS and TID results

The results from the ELDRS test were compared to the Total Ionizing Dose¹ test results performed on the same manufacturer's lot, H916391. A comparison of the Output Voltage for the product shows no significant difference in radiation response between the high and low dose rate tests. The radiation response for the Output Voltage parameter test results for both the high and low dose rate tests are displayed in Figures 5 thru 8.

Figure 5

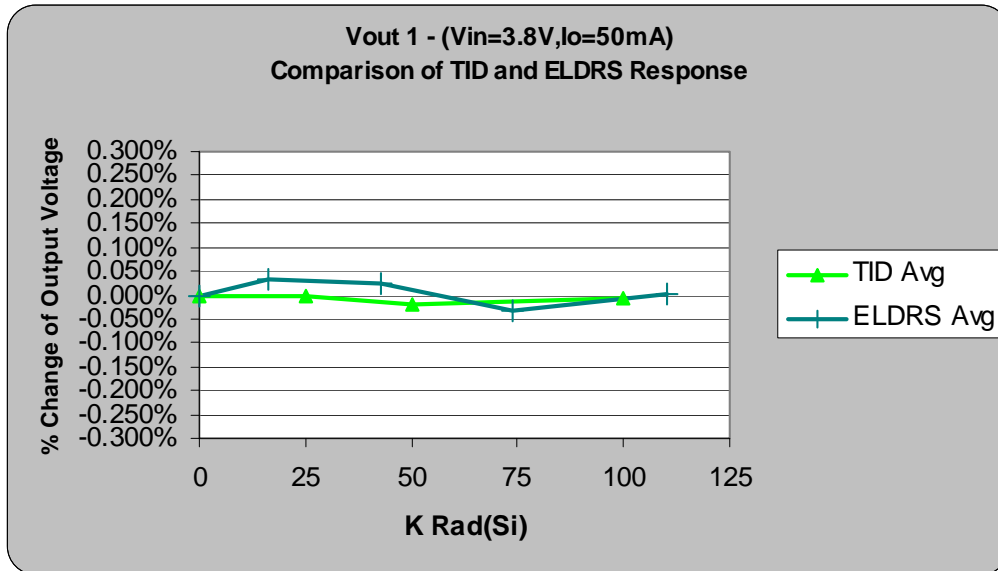
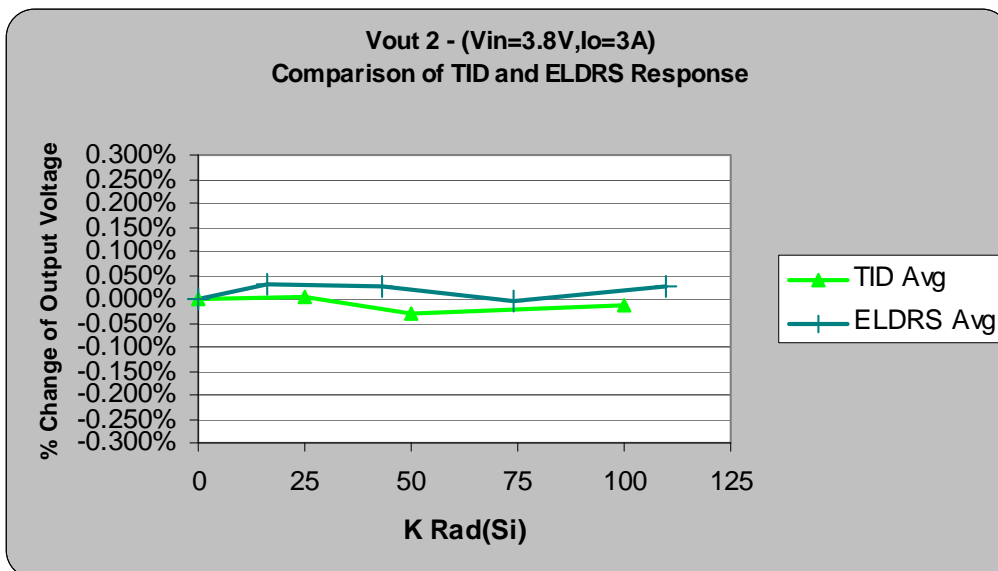

Figure 6



¹ The data used for this comparison is documented in the Total Ionizing Dose Test Report, July 2010.

Figure 7

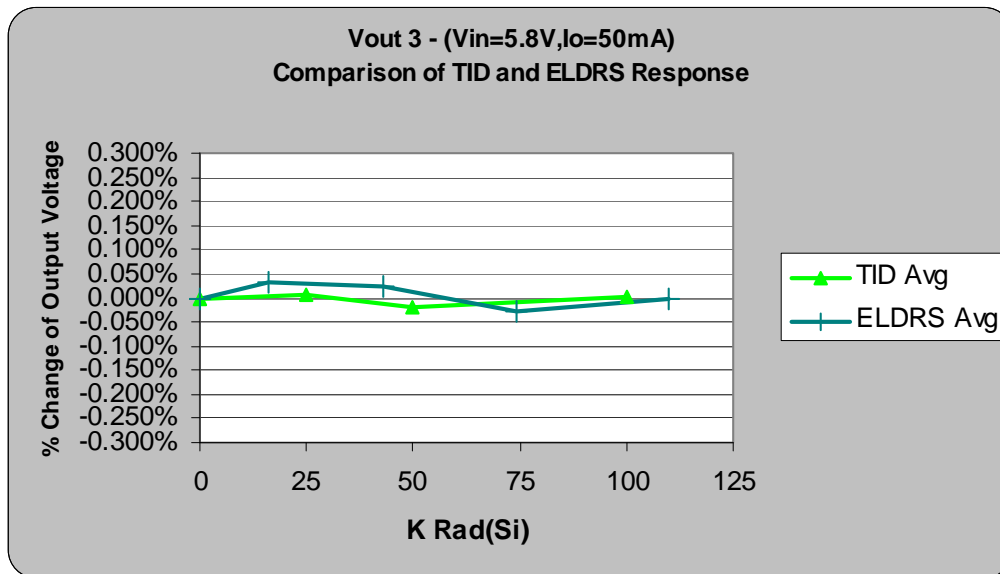
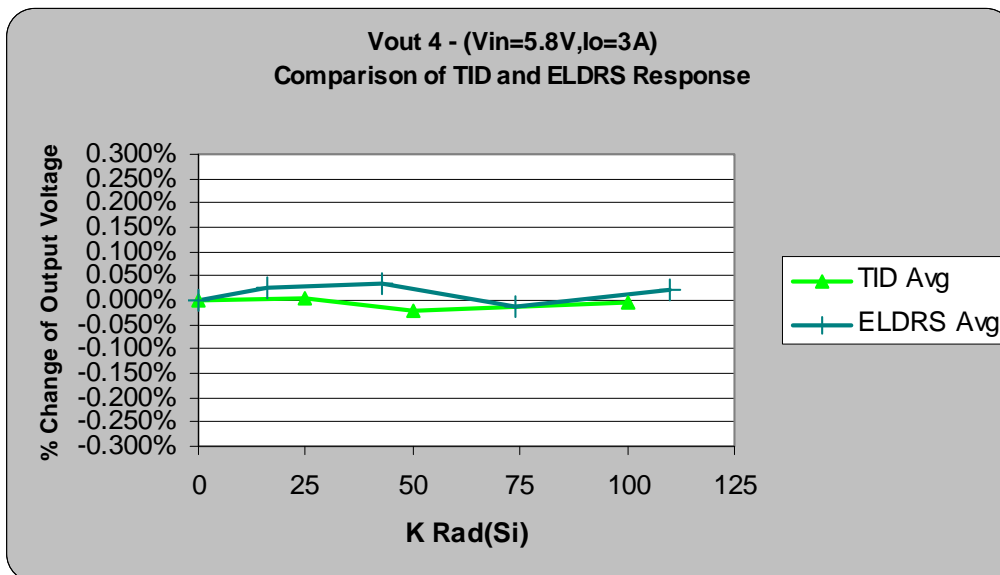

Figure 8



CONCLUSION

The IRUH3301 product has demonstrated hardness to low dose rate ionizing radiation exposure up to 100 KRad(Si) with no failures when device is in the “ON” or “OFF” bias condition.

Furthermore when the low and high dose rate test results were compared there were no measurable differences between the two.

Appendix A

Electrical Data

Electrical Test Data (Pre-radiation)

Rad Level (K)	Vout (Vin=3.8V, I _o =50mA)	Vout (Vin=3.8V, I _o =3A)	Vout (Vin=5.8V, I _o =50mA)	Vout (Vin=5.8V, I _o =3A)	Over Current Latchup	Dropout Voltage	Shutdown Threshold On	Shutdown Threshold Off	Vout @ Shutdown
0	3	4	5	6	7	9	10	11	12
Min	2.462	2.462	2.462	2.462	3.5	0	0.8	0.8	-100
Max	2.537	2.537	2.537	2.537	15	0.4	1.2	1.2	100
	V	V	V	V	A	V	V	V	mV
Serial #									
68	2.51	2.511	2.511	2.512	9.58	0.304	1.03	0.96	2.6
81	2.487	2.488	2.487	2.488	9.58	0.267	1.04	0.97	2.5
76	2.483	2.483	2.483	2.483	9.67	0.325	1.04	0.97	2.6
84	2.501	2.503	2.501	2.503	9.78	0.283	1.03	0.96	2.6
59	2.494	2.495	2.494	2.495	9.68	0.29	1.05	0.98	2.6
27	2.47	2.471	2.47	2.471	9.68	0.284	1.04	0.96	2.7
88	2.501	2.502	2.501	2.502	9.28	0.314	1.05	0.98	2.5
60	2.507	2.508	2.507	2.508	9.58	0.338	1.04	0.97	2.6
5	2.527	2.528	2.527	2.528	9.37	0.318	1.05	0.97	2.6
44	2.501	2.502	2.501	2.502	9.98	0.284	1.05	0.97	2.5
31	2.502	2.503	2.501	2.502	9.58	0.314	1.04	0.97	2.6

Electrical Test Data (Post radiation -16K RAD(Si))

Rad Level (K)	Vout (Vin=3.8V, I _o =50mA)	Vout (Vin=3.8V, I _o =3A)	Vout (Vin=5.8V, I _o =50mA)	Vout (Vin=5.8V, I _o =3A)	Over Current Latchup	Dropout Voltage	Shutdown Threshold On	Shutdown Threshold Off	Vout @ Shutdown
16	3.3	4.3	5.3	6.3	7.3	9.3	10.3	11.3	12.3
Min	2.424	2.424	2.424	2.424	3.5	0	0.8	0.8	-100
Max	2.537	2.537	2.537	2.537	15	0.4	1.2	1.2	100
	V	V	V	V	A	V	V	V	mV
Serial #									
68	2.51	2.511	2.51	2.511	9.48	0.335	1.03	0.96	2.5
81	2.487	2.488	2.488	2.488	9.68	0.327	1.04	0.97	2.4
76	2.484	2.485	2.484	2.485	9.48	0.3	1.04	0.97	2.6
84	2.502	2.503	2.502	2.504	9.67	0.282	1.03	0.96	2.7
59	2.495	2.496	2.495	2.496	9.77	0.29	1.05	0.98	2.6
27	2.471	2.472	2.471	2.472	9.58	0.283	1.04	0.96	2.5
88	2.499	2.5	2.499	2.5	9.08	0.346	1.05	0.98	2.5
60	2.507	2.508	2.507	2.508	9.48	0.367	1.04	0.97	2.6
5	2.532	2.533	2.532	2.532	9.48	0.284	1.05	0.97	2.7
44	2.502	2.503	2.502	2.504	9.57	0.372	1.05	0.98	2.6
31	2.499	2.5	2.499	2.5	9.58	0.316	1.04	0.97	2.6

Device 31 is the control.

Electrical Test Data (Post radiation – 43K RAD(Si))

Rad Level (K)	Vout (Vin=3.8V, I _o =50mA)	Vout (Vin=3.8V, I _o =3A)	Vout (Vin=5.8V, I _o =50mA)	Vout (Vin=5.8V, I _o =3A)	Over Current Latchup	Dropout Voltage	Shutdown Threshold On	Shutdown Threshold Off	Vout @ Shutdown
43	3.3	4.3	5.3	6.3	7.3	9.3	10.3	11.3	12.3
Min	2.424	2.424	2.424	2.424	3.5	0	0.8	0.8	-100
Max	2.537	2.537	2.537	2.537	15	0.4	1.2	1.2	100
	V	V	V	V	A	V	V	V	mV
Serial #									
68	2.511	2.512	2.511	2.513	9.48	0.304	1.03	0.96	2.6
81	2.487	2.488	2.487	2.489	9.48	0.297	1.04	0.97	2.4
76	2.483	2.484	2.483	2.484	9.18	0.331	1.05	0.97	2.6
84	2.502	2.504	2.502	2.504	9.08	0.312	1.03	0.96	2.7
59	2.494	2.495	2.494	2.495	9.38	0.291	1.05	0.98	2.6
27	2.472	2.473	2.472	2.473	9.38	0.282	1.04	0.96	2.4
88	2.499	2.5	2.499	2.5	8.88	0.375	1.05	0.98	2.5
60	2.504	2.505	2.505	2.506	9.28	0.311	1.04	0.96	2.6
5	2.533	2.534	2.533	2.534	9.17	0.313	1.05	0.97	2.8
44	2.501	2.502	2.501	2.502	9.38	0.313	1.05	0.97	2.4
31	2.497	2.498	2.498	2.498	9.58	0.317	1.04	0.97	2.5

Electrical Test Data (Post radiation – 74K RAD(Si))

Rad Level (K)	Vout (Vin=3.8V, I _o =50mA)	Vout (Vin=3.8V, I _o =3A)	Vout (Vin=5.8V, I _o =50mA)	Vout (Vin=5.8V, I _o =3A)	Over Current Latchup	Dropout Voltage	Shutdown Threshold On	Shutdown Threshold Off	Vout @ Shutdown
74	3.3	4.3	5.3	6.3	7.3	9.3	10.3	11.3	12.3
Min	2.424	2.424	2.424	2.424	3.5	0	0.8	0.8	-100
Max	2.537	2.537	2.537	2.537	15	0.4	1.2	1.2	100
	V	V	V	V	A	V	V	V	mV
Serial #									
68	2.511	2.513	2.511	2.513	9.37	0.303	1.03	0.96	2.7
81	2.486	2.488	2.486	2.488	9.27	0.298	1.04	0.97	2.5
76	2.484	2.486	2.484	2.486	8.98	0.33	1.05	0.97	2.6
84	2.5	2.502	2.5	2.502	8.87	0.344	1.03	0.96	2.5
59	2.491	2.492	2.491	2.492	9.07	0.324	1.05	0.98	2.6
27	2.469	2.47	2.469	2.47	8.98	0.346	1.04	0.96	2.5
88	2.498	2.499	2.498	2.499	8.78	0.347	1.05	0.98	2.5
60	2.505	2.507	2.506	2.507	9.17	0.339	1.04	0.96	2.6
5	2.529	2.531	2.53	2.53	8.78	0.316	1.05	0.97	2.7
44	2.499	2.5	2.499	2.5	9.18	0.405	1.05	0.97	2.6
31	2.5	2.502	2.5	2.502	9.48	0.344	1.04	0.97	2.6

Device 31 is the control.

Electrical Test Data (Post radiation – 110K RAD(Si))

Rad Level (K)	Vout (Vin=3.8V, I _o =50mA)	Vout (Vin=3.8V, I _o =3A)	Vout (Vin=5.8V, I _o =50mA)	Vout (Vin=5.8V, I _o =3A)	Over Current Latchup	Dropout Voltage	Shutdown Threshold On	Shutdown Threshold Off	Vout @ Shutdown
110	3.3	4.3	5.3	6.3	7.3	9.3	10.3	11.3	12.3
Min	2.424	2.424	2.424	2.424	3.5	0	0.8	0.8	-100
Max	2.537	2.537	2.537	2.537	15	0.4	1.2	1.2	100
	V	V	V	V	A	V	V	V	mV
Serial #									
68	2.509	2.51	2.509	2.511	9.08	0.336	1.03	0.96	2.6
81	2.485	2.486	2.485	2.486	9.18	0.299	1.04	0.97	2.6
76	2.49	2.493	2.49	2.493	9.07	0.353	1.05	0.97	2.6
84	2.5	2.502	2.5	2.502	8.68	0.374	1.03	0.96	2.6
59	2.49	2.491	2.49	2.491	8.98	0.324	1.05	0.98	2.6
27	2.469	2.471	2.469	2.47	8.98	0.315	1.04	0.96	2.5
88	2.498	2.499	2.498	2.499	8.69	0.348	1.05	0.98	2.6
60	2.506	2.508	2.506	2.508	8.98	0.368	1.04	0.96	2.7
5	2.534	2.535	2.534	2.535	8.68	0.341	1.05	0.97	2.7
44	2.499	2.5	2.499	2.5	9.17	0.346	1.05	0.97	2.6
31	2.497	2.498	2.498	2.498	9.77	0.287	1.04	0.97	2.6

Device 31 is the control.

Appendix B

Radiation Test Specification

Table 1: Pre Radiation Tests, 25C only								
Prog.	Test	Symbol	Test Conditions	Rad Level:	Notes	MIN	MAX	Units
A	Output Voltage	Vout	Vout (Vin=3.8V,Io=50mA)	Pre Rad		2.462	2.537	V
A	Output Voltage	Vout	Vout (Vin=3.8V,Io=3A)	Pre Rad		2.462	2.537	V
A	Output Voltage	Vout	Vout (Vin=5.8V,Io=50mA)	Pre Rad		2.462	2.537	V
A	Output Voltage	Vout	Vout (Vin=5.8V,Io=3A)	Pre Rad		2.462	2.537	V
A	Dropout Voltage	Vdrop	I _o =3A	Pre Rad		0.00	0.40	V
A	Over Current Latchup	I _{latch}	V _{in} =5.0V	Pre Rad		3.50	15.00	A
A	Shutdown Threshold off	V _{shdn}	V _{in} =5.0V, VSHUTDOWN RAMP from 0.5V to 2.0V, output monitored for a 1% drop below The nominal of V _{out} .	Pre Rad		0.80	1.20	V
A	Shutdown Threshold On	V _{shdn}	V _{in} =5.0V, VSHUTDOWN RAMP from 2.0V to 0.5V, output monitored for 500mV of V _{out} .	Pre Rad		0.80	1.20	V
A	V _{out} @ Shutdown	V _{oshdn}	V _{in} =5.0V, I _o =0A, SHD=5.0V	Pre Rad		-0.10	0.10	V

Table 2: Post Radiation Tests, 25C only, all radiation levels								
Prog.	Test	Symbol	Test Conditions	Rad Level:	Notes	MIN	MAX	Units
B	Output Voltage	Vout	Vout (Vin=3.8V, Io=50mA)	Post Rad		2.437	2.549	V
B	Output Voltage	Vout	Vout (Vin=3.8V, Io=3A)	Post Rad		2.437	2.549	V
B	Output Voltage	Vout	Vout (Vin=5.8V, Io=50mA)	Post Rad		2.437	2.549	V
B	Output Voltage	Vout	Vout (Vin=5.8V, Io=3A)	Post Rad		2.437	2.549	V
B	Dropout Voltage	Vdrop	Io=3A	Post Rad		0.00	0.40	V
A	Over Current Latchup	Ilatch	Vin=5.0V	Post Rad		3.50	15.00	A
B	Shutdown Threshold off	Vshdn	Vin=5.0V, VSHUTDOWN RAMP from 0.5V to 2.0V, output monitored for a 1% drop below The nominal of Vout.	Post Rad		0.80	1.20	V
B	Shutdown Threshold On	Vshdn	Vin=5.0V, VSHUTDOWN RAMP from 2.0V to 0.5V, output monitored for 500mV of Vout.	Post Rad		0.80	1.20	V
B	Vout@ Shutdown	Voshdn	Vin=5.0V, Io=0A, SHD=5.0V	Post Rad		-0.10	0.10	V

Low Dose Rate		
Bias Conditions	Vin = 0V Un Biased	Vin = 6.4V Bias (80% of Max Voltage rating)
Dose Step Profile ¹	10K, 10K, 30K, 50K	10K, 10K, 30K, 50K
Dose Rate Range	0.01Rad(Si)/Sec	0.01Rad(Si)/Sec
Board Number	09-082-TF, 09-107-TF	09-082-TF, 09-107-TF
Board Leakage	N/A	Max = 100E-6 Min = 50E-6
Program Card Number	N/A	N/A
Chamber	Hot Cell	Hot Cell
Test Temperature	25C +/-5C	25C +/-5C

1. The dose step profile for low dose testing is for reference only. This profile will vary depending on the facility availability to open the cell for interim tests.

On Bias

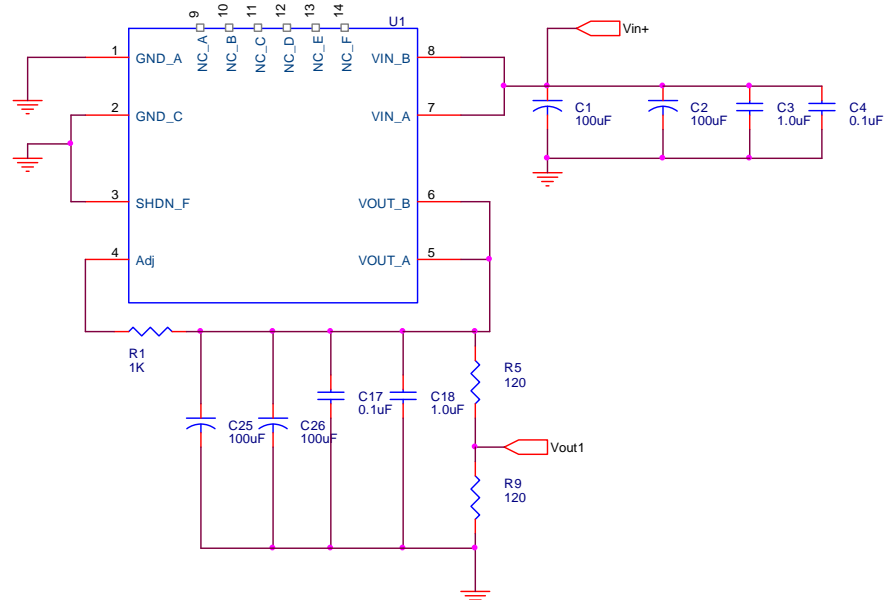

Off Bias

