

**EMI FILTER
HYBRID-HIGH RELIABILITY**

Description

The SF461 Series EMI filter is designed to provide full compliance with the input line reflected ripple current requirement specified by CE03 of MIL-STD-461C over the extended temperature range while operating in conjunction with the corresponding S-Series of DC-DC converters. The filter is offered as part of a family of high reliability conversion products providing single and dual output voltages while operating on nominal 28V input line. Other converters operating with a similar switching frequency could also benefit by use of this device.

The SF461 filter is hermetically sealed in a seam welded enclosure utilizing axially oriented surface-mountable copper-core pins which minimize resistive DC losses. The package is fabricated with IR HiRel's rugged ceramic lead-to-package seal assuring long term hermetic seal integrity in harsh environments.

The filter is manufactured in a facility fully qualified to MIL-PRF-38534, and is available in two screening grades. The flight grade is designed with the requirements of MIL-PRF-38534 for class K.

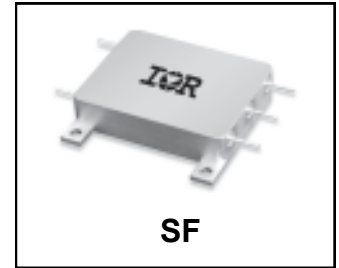

Features

- Up to 2.0 A Output Current
- Attenuation > 60dB @ 500 kHz
- Low Profile Seam Welded Package
- Ceramic Insulated Copper Core Pins
- Operation Over the Temperature Range -55°C to 125°C without Power Derating
- Class K Screened per MIL-STD-38534
- MIL-PRF-38534 Element Evaluated Components
- Enabling S-Series DC-DC Converters to meet CE03 Requirements of MIL-STD-461C
- Derated per MIL-STD-1547 and IEEE-INST-002

The EM grade is processed and screened to a lower grade requirement. Flight grade is tested to meet the complete group "A" test specifications over the wide temperature range with no derating. The filter is designed to meet the derating guidelines of MIL-STD-1547 and IEEE-INST-002.

Typical Connection Diagram

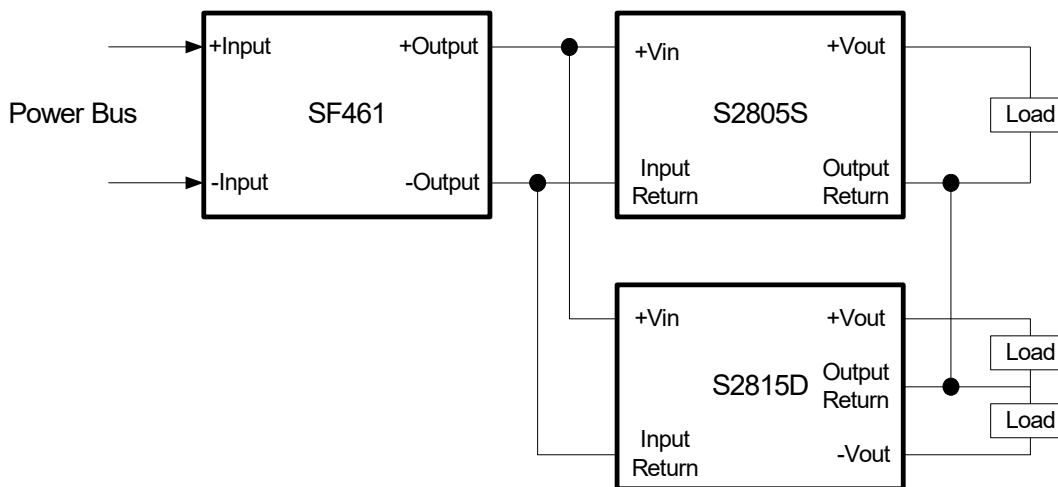

Notes

1. One SF461 filter may be able to accommodate more than two S-Series converters at nominal voltage with rated load while not exceeding maximum power limit.

Absolute Maximum Ratings, Note 1

Input Voltage	-100V to +100V, Note 2
Input Current	3.0A
Lead Soldering Temperature	+300°C for 10 seconds
Case Temperature-Operating	-55°C to +125°C
Case Temperature-Storage	-55°C to +135°C

Specifications $-55^{\circ}\text{C} \leq T_{\text{CASE}} \leq +125^{\circ}\text{C}$, unless otherwise specified

Parameter	Group A Subgroup	Conditions	Min.	Nom.	Max.	Unit
Input Voltage		Steady State	-40	—	+40	V_{DC}
		Transient, Notes 2, 5	-100	—	+100	
Output Voltage	1, 2, 3	Continuous	$V_{\text{OUT}} = V_{\text{IN}} - I_{\text{IN}} (R_{\text{DC}})$			V_{DC}
Output Current, Note 3			—	—	2.0	A_{DC}
DC Resistance, Note 4	1	$T_{\text{C}} = 25^{\circ}\text{C}$	—	150	250	$\text{m}\Omega$
Power Dissipation		Maximum Current, $T_{\text{C}} = 25^{\circ}\text{C}$	—	—	1.0	W
Noise Reduction	4, 5, 6	1.0 kHz	-1.0	—	+1.0	dB
		200 kHz - 500 kHz	40	—	—	
		500 kHz - 10 MHz	60	—	—	
Isolation	1	Any Pin to Case, Tested @ $500V_{\text{DC}}$	100	—	—	$\text{M}\Omega$
Capacitance	1, 2, 3	Measured between any Pin and Case	32	—	48	nF
Device Weight		Slight variations with Case Style	—	30	—	g

Notes to Specifications

1. Operation above maximum ratings may cause permanent damage to the device. Operation at maximum ratings may degrade performance and affect reliability.
2. Device can tolerate ± 100 Volt transient whose duration is $\leq 100\text{ms}$ when $R_{\text{S}} \geq 0.5\Omega$.
3. Derate Output current linearly from 100% at 125°C to 0 at 135°C .
4. DC resistance is the total resistance of the device and includes the sum of the input to output resistance and the return in to return out resistance paths.
5. Derating guidelines do not apply for any input voltage transient conditions.

Typical EMI Filter CE03 Performance Curves

Fig 1. Positive Input Line without an external EMI Filter for $V_{IN} = 28V$ and Rated Load, S2805S

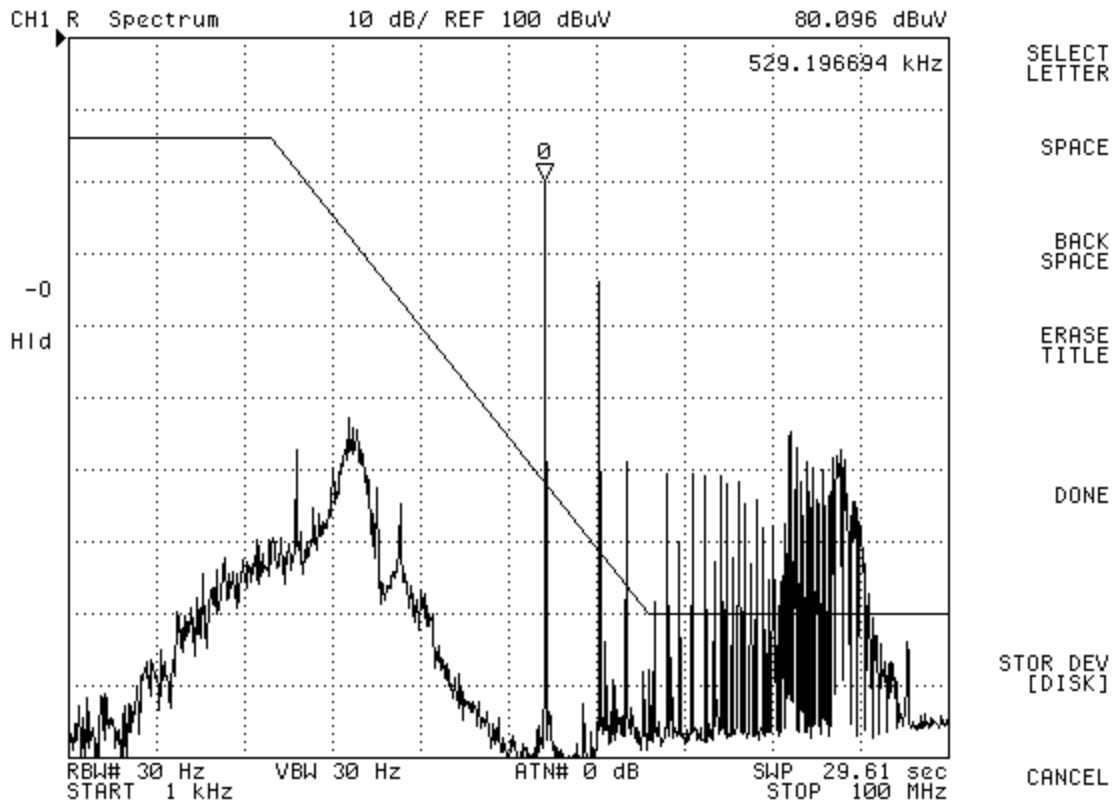

Fig 2. Positive Input Line with SF461 GEN II EMI Filter for $V_{IN} = 28V$ and Rated Load, S2805S

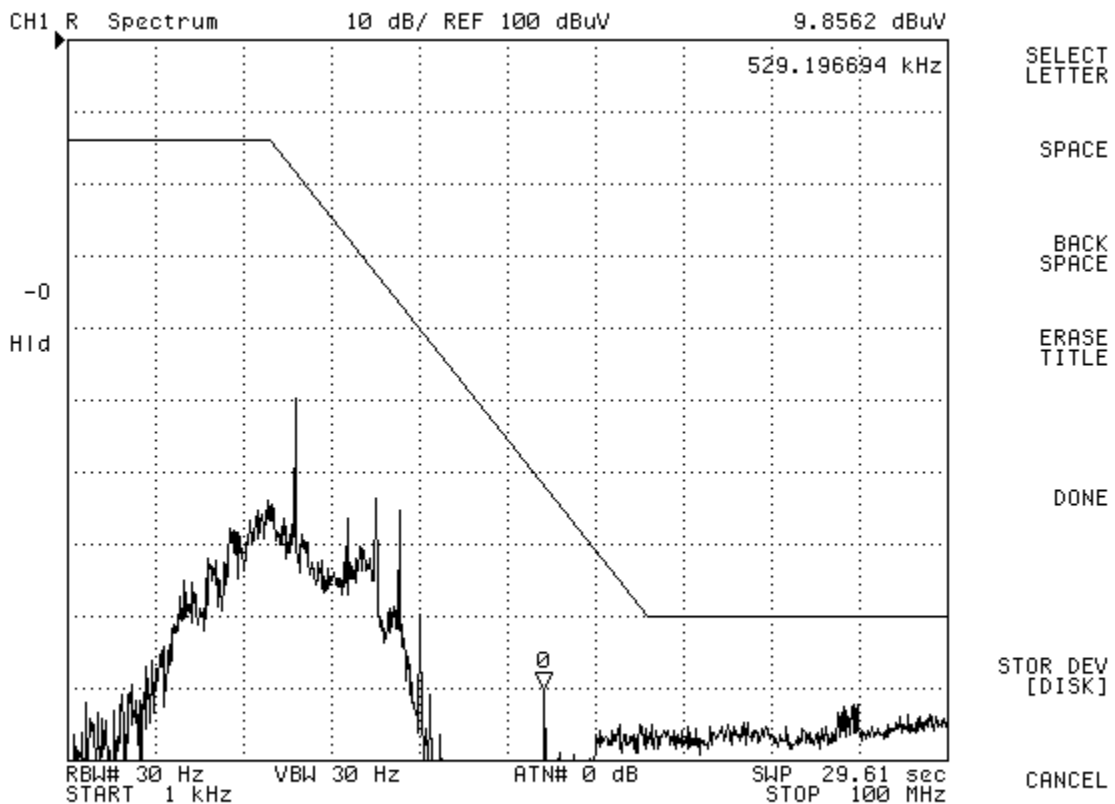

Fig 3. Common Mode without an external EMI Filter for $V_{IN} = 28V$ and Rated Load, S2805S

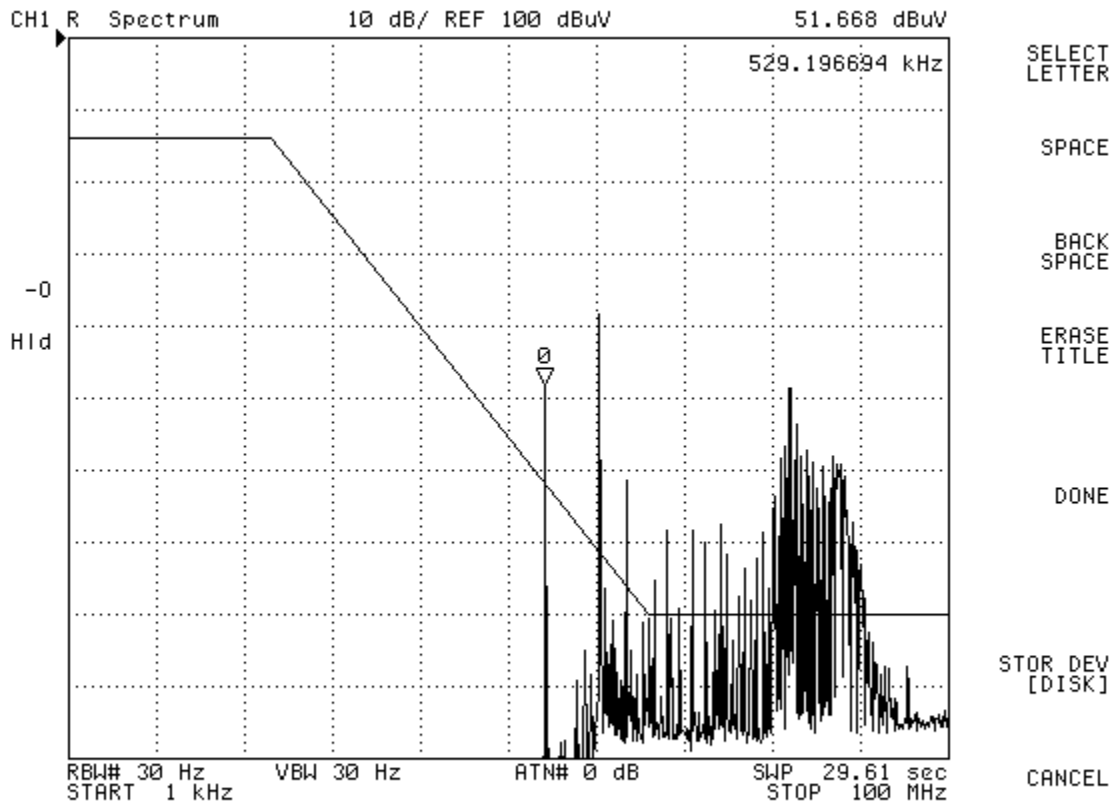
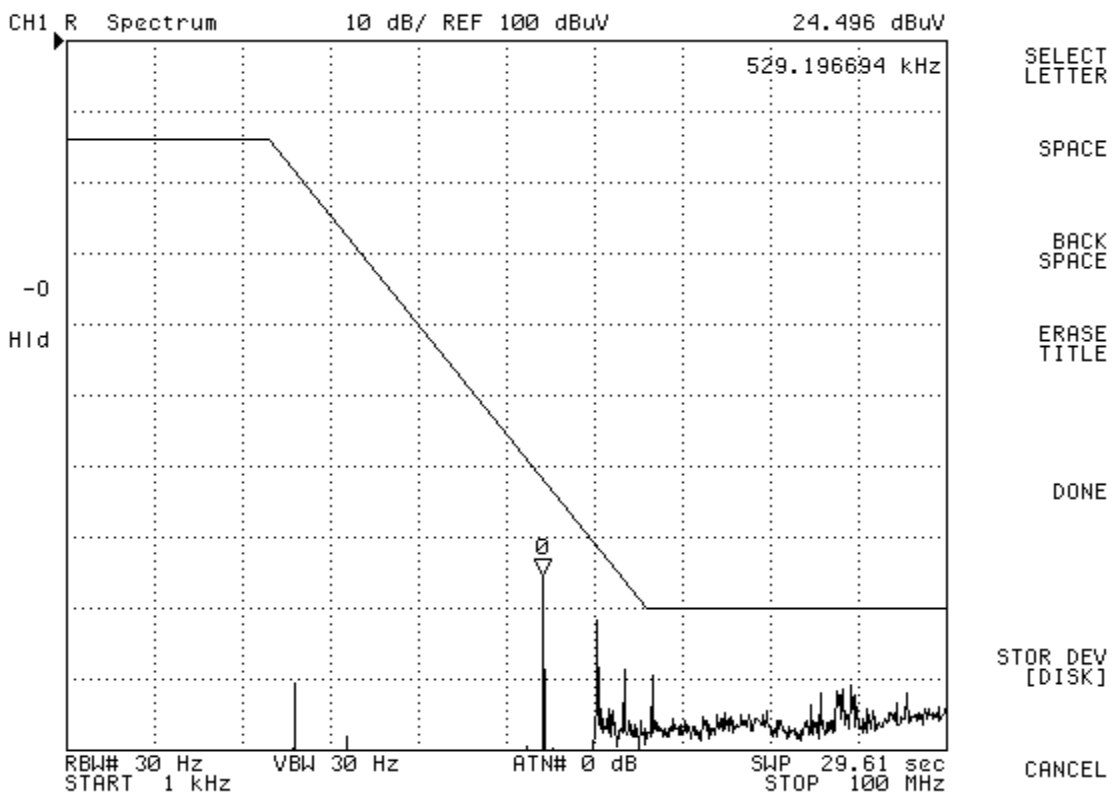

Fig 4. Common Mode with SF461 GEN II EMI Filter for $V_{IN} = 28V$ and Rated Load, S2805S



Mechanical Outline

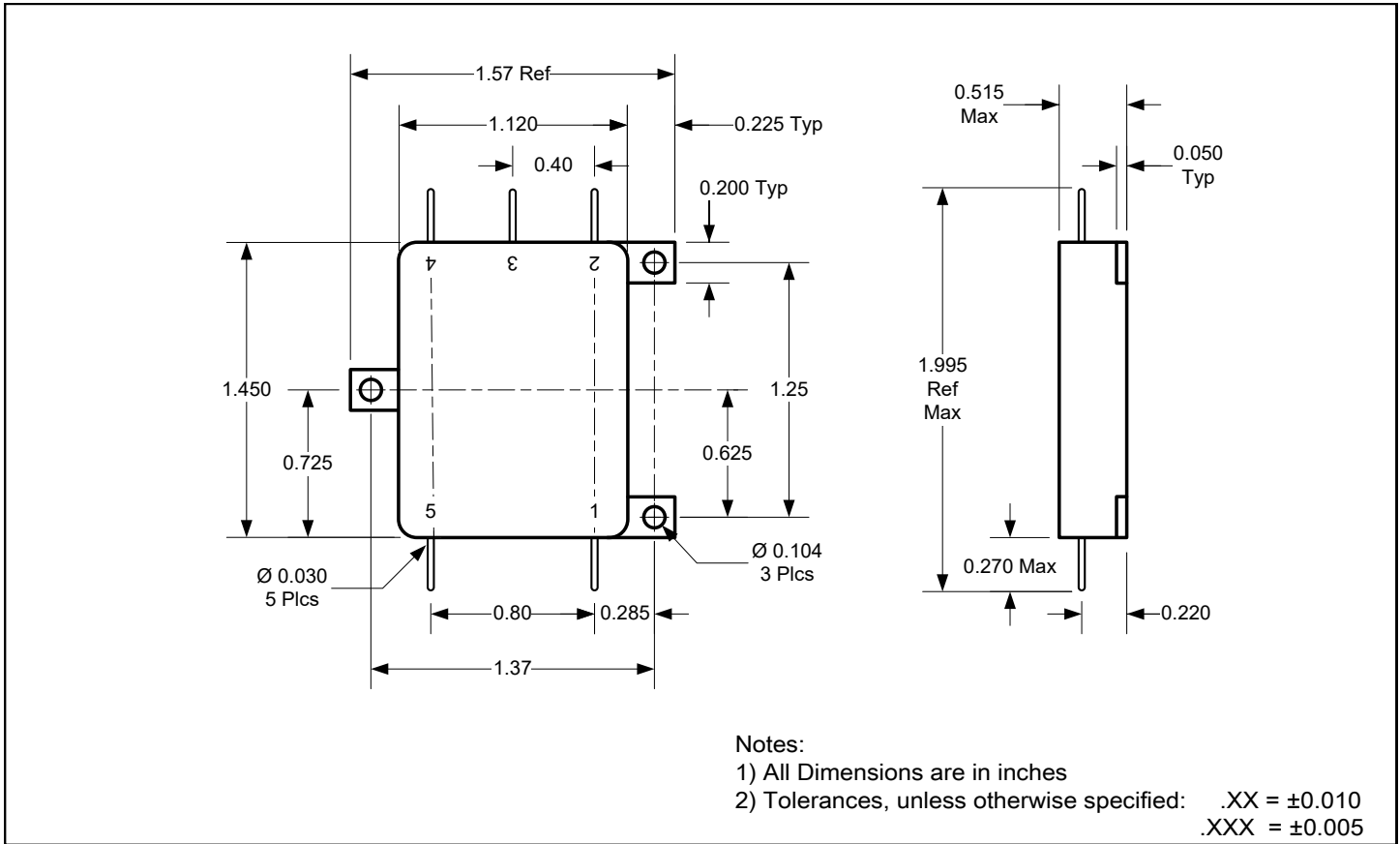
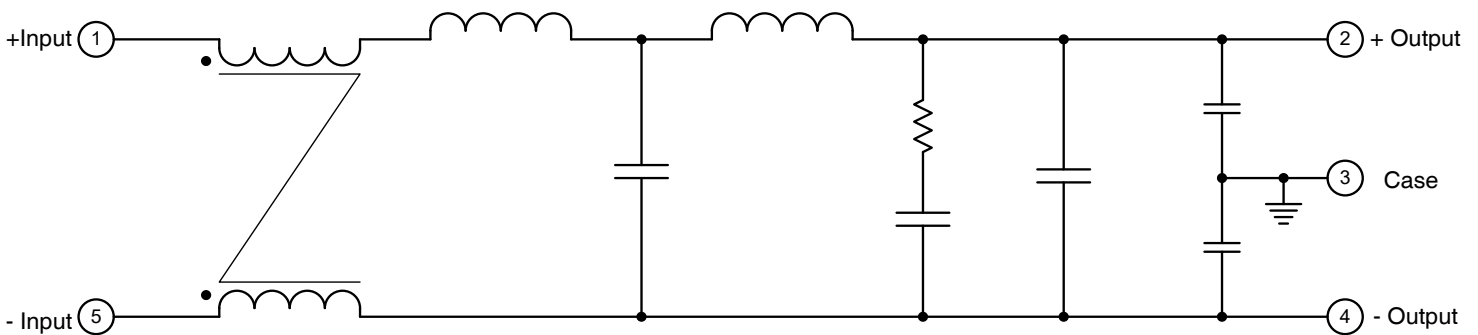

Fig 5. Block Diagram



Pin Designation

Pin #	Designation
1	+ Input
2	+ Output
3	Case Ground
4	- Output
5	- Input

Device Screening

Part Number Designator		/EM ①	Flight No Suffix
Compliance Level	MIL-PRF-38534	—	—
Certification Mark		—	—
Screening Requirement	MIL-STD-883 Method	—	—
Temperature Range	—	Room Temperature	-55°C to +125°C
Element Evaluation	MIL-PRF-38534	N/A	Class K
Non-Destructive Bond Pull	2023	N/A	Yes
Internal Visual	2017	IR Defined	Yes
Temperature Cycle	1010	N/A	Cond C
Constant Acceleration	2001, Y1 Axis	N/A	3000 Gs
PIND	2020	N/A	Cond A
Burn-In	1015	N/A	320 hrs @ 125°C (2 x 160 hrs)
Final Electrical (Group A)	MIL-PRF-38534 & Specification	Room Temperature	-55°C, +25°C, +125°C
PDA	MIL-PRF-38534	N/A	2%
Seal, Fine and Gross	1014	N/A	Cond CH
Radiographic	2012	N/A	Yes
External Visual	2009	IR Defined	Yes

Notes:

- ① “EM” grade parts are strictly intended to permit the customer to determine the electrical functionality of the device in the customer’s application in ambient conditions. The use of EM devices in production applications presents an unquantifiable risk of failure and IR HiRel disclaims all responsibility for such failure.

Part Numbering

SF 461 GEN II / EM

Model

2nd Generation
Design with
Enhanced
Performance

Screening Level

(Refer to Screening Table)

EM = Minimal Screening

Blank = Space Flight Model



An Infineon Technologies Company

www.infineon.com/irhirel

Infineon Technologies Service Center: USA Tel: +1 (866) 951-9519 and International Tel: +49 89 234 65555
Leominster, Massachusetts 01453, USA Tel: +1 (978) 534-5776
San Jose, California 95134, USA Tel: +1 (408) 434-5000
Data and specifications subject to change without notice.

IMPORTANT NOTICE

The information given in this document shall be in no event regarded as guarantee of conditions or characteristic. The data contained herein is a characterization of the component based on internal standards and is intended to demonstrate and provide guidance for typical part performance. It will require further evaluation, qualification and analysis to determine suitability in the application environment to confirm compliance to your system requirements.

With respect to any example hints or any typical values stated herein and/or any information regarding the application of the product, Infineon Technologies hereby disclaims any and all warranties and liabilities of any kind including without limitation warranties on non- infringement of intellectual property rights and any third party.

In addition, any information given in this document is subject to customer's compliance with its obligations stated in this document and any applicable legal requirements, norms and standards concerning customer's product and any use of the product of Infineon Technologies in customer's applications.

The data contained in this document is exclusively intended for technically trained staff. It is the responsibility of any customer's technical departments to evaluate the suitability of the product for the intended applications and the completeness of the product information given in this document with respect to applications.

For further information on the product, technology, delivery terms and conditions and prices, please contact your local sales representative or go to (www.infineon.com/irhirel)

WARNING

Due to technical requirements products may contain dangerous substances. For information on the types in question, please contact your nearest Infineon Technologies office.