

5 AMP LOW DROPOUT POSITIVE ADJUSTABLE REGULATOR APPROVED TO DESC DRAWING 5962-89521

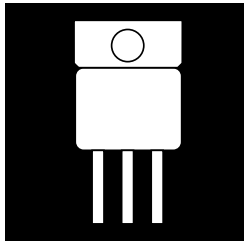

**Three Terminal, Positive Adjustable
Low Dropout Voltage Regulator In
Hermetic Packages**

FEATURES

- Similar To Industry Standard LT1084
- Approved To DESC Standardized Military Drawing Number 5962-89521
- Adjustable Output Voltage
- Built In Thermal Overload Protection
- Short Circuit Current Limiting
- Maximum Output Voltage Tolerance is Guaranteed To $\pm 1\%$
- Guaranteed Dropout Voltage At Multiple Current Levels
- TO-258 Available in Isolated and Non-Isolated Packages

DESCRIPTION

This three terminal positive adjustable voltage regulator is designed to provide 5A with higher efficiency than conventional voltage regulators. This device is designed to operate down to 1 Volt input to output differential and the dropout voltage is fully specified as a function of load current. Supplied in easy-to-use hermetic TO-258 and TO-3 packages, this device is ideally suited for Military applications where small size and high reliability is required.

ABSOLUTE MAXIMUM RATINGS @ 25°C

Power Dissipation (P_d)	Internally Limited
Input - Output Voltage Differential	35 V
Operating Junction Temperature Range	- 55°C to + 150°C
Storage Temperature Range	- 65°C to + 150°C
Lead Temperature (Soldering 10 seconds)	300°C
Thermal Resistance:	
θ_{JC} (TO-258 Isolated)	3.0°C/W
θ_{JC} (TO-258 Non-Isolated)	2.3°C/W
θ_{JC} (TO-3)	3.0°C/W
Maximum Output Current	5.0 A
Recommended Operating Conditions:	
Output Voltage Range	3.3V to 15 V
Ambient Operating Temperature Range (T_A)	- 55°C to + 125°C
Input Voltage Range	5V to 25 V

3.3

OM1840SCM OM1840NCM OM1840NKM

ELECTRICAL CHARACTERISTICS $-55^{\circ}\text{C} \leq T_A \leq +125^{\circ}\text{C}$ (unless otherwise specified)

Parameter	Symbol	Test Conditions	Min.	Max.	Unit
Reference Voltage	V_{REF}	$ V_{IN} - V_{OUT} = 3.0\text{ V}$, $I_{OUT} = 10\text{ mA}$, $T_A = 25^{\circ}\text{C}$	1.238	1.262	V
		$1.5\text{ V} \leq V_{IN} - V_{OUT} \leq 25\text{ V}$, $I_{OUT} = 10\text{ mA}$, $I_{FL} = 3.0\text{ A}$	• 1.225	1.270	V
Line Regulation (Note 1)	$\frac{\Delta V_{OUT}}{\Delta V_{IN}}$	$1.5\text{ V} \leq V_{IN} - V_{OUT} \leq 15\text{ V}$, $I_{OUT} = 10\text{ mA}$, $T_A = 25^{\circ}\text{C}$		0.2	%
		$15\text{ V} \leq V_{IN} - V_{OUT} \leq 35\text{ V}$, $I_{OUT} = 10\text{ mA}$	•	0.5	%
Load Regulation (Note 1)	$\frac{\Delta V_{OUT}}{\Delta I_{OUT}}$	$ V_{IN} - V_{OUT} = 3.0\text{ V}$, $T_A = 25^{\circ}\text{C}$ $I_{OUT} = 10\text{ mA}$, $I_{FL} = 3.0\text{ A}$		0.3	%
			•	0.4	%
Dropout Voltage	V_{DO}	$I_{FL} = 3.0\text{ A}$, $\Delta V_{REF} = 1\%$	•	1.5	V
Thermal Regulation	-	30 ms pulse, $T_A = +25^{\circ}\text{C}$		0.015	%/W
Ripple Rejection	$\frac{\Delta V_{IN}}{\Delta V_{OUT}}$	$f = 120\text{ Hz}$, $C_{Adj} = 25\text{ }\mu\text{F}$, $C_{OUT} = 25\text{ }\mu\text{F}$ (tantalum), $I_{FL} = 3.0\text{ A}$, $ V_{IN} - V_{OUT} = 3.0\text{ V}$	• 60		dB
Adjust Pin Current	I_{Adj}	$1.5\text{ V} \leq V_{IN} - V_{OUT} \leq 25\text{ V}$, $I_{OUT} = 10\text{ mA}$, $I_{FL} = 3.0\text{ A}$	•	120	μA
Adjust Pin Current Change	ΔI_{Adj}	$1.5\text{ V} \leq V_{IN} - V_{OUT} \leq 25\text{ V}$, $10\text{ mA} \leq I_{OUT} \leq 3.0\text{ A}$	•	5.0	μA
Minimum Load Current	I_{Min}	$ V_{IN} - V_{OUT} = 25\text{ V}$	•	10	mA
Current Limit	I_{Lim}	$ V_{IN} - V_{OUT} \leq 5.0\text{ V}$	• 5.5		A
		$ V_{IN} - V_{OUT} = 25\text{ V}$	• 0.3		A
Temperature Stability (Note 2)	$\frac{\Delta V_{OUT}}{\Delta T}$	$-55^{\circ}\text{C} \leq T_J \leq +125^{\circ}\text{C}$	•	1.5	%
Long Term Stability (Note 2)	$\frac{\Delta V_{OUT}}{\Delta T}$	$T_A = +125^{\circ}\text{C}$, $t = 1000\text{ hrs}$		1.0	%

Notes:

- Line and Load Regulation are measured at a constant junction temperature using a low duty cycle pulse technique. Although power dissipation is internally limited, regulation is guaranteed up to the maximum power dissipation of 45 W. Power dissipation is determined by the input/output differential voltage and the output current. Guaranteed maximum power dissipation will not be available over the full input/output voltage range.
- Guaranteed by design, characterization or correlation to other tested parameters.
- The • denotes the specifications which apply over the full operating temperature range.

3.3

PART NUMBER DESIGNATOR	
Standard Military Drawing Number	Omnirel Part Number
8952101Y	OM1840SCM
8952101Z	OM1840NCM
8952101X	OM1840NKM
"Y" = Isolated "Z" = Non-Isolated	

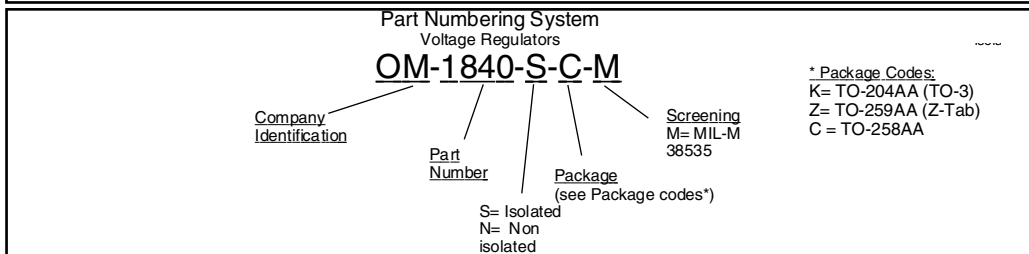

International Rectifier Companies
The Hi-Rel Components & Subsystems Group

TYPICAL PERFORMANCE CHARACTERISTICS

LOAD REGULATION

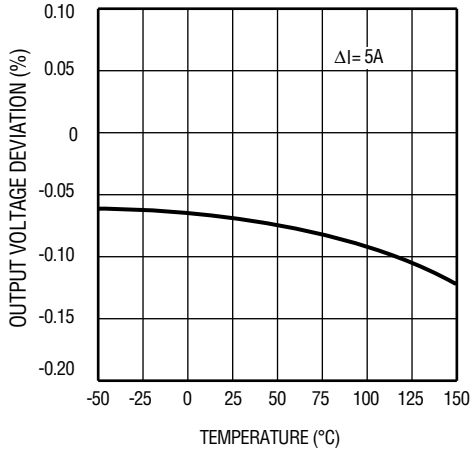

SHORT CIRCUIT CURRENT

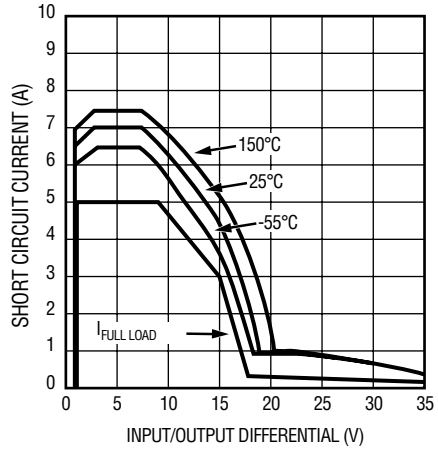

ADJUSTMENT PIN CURRENT

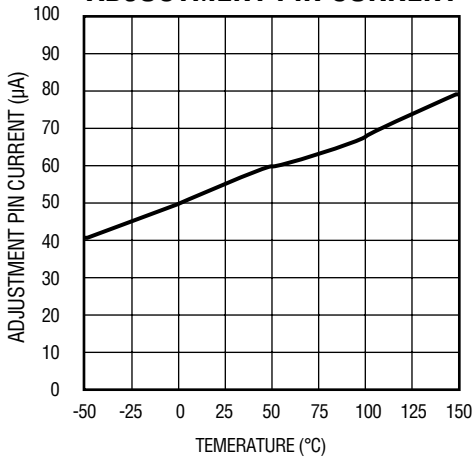

DROPOUT VOLTAGE

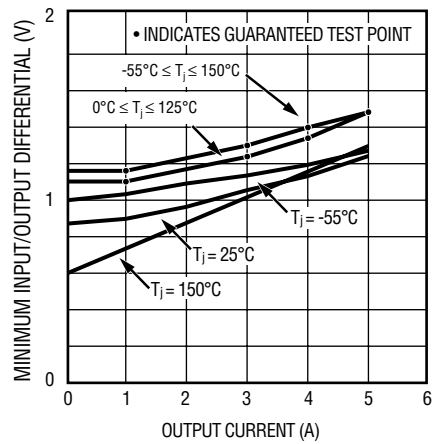

TEMPERATURE STABILITY

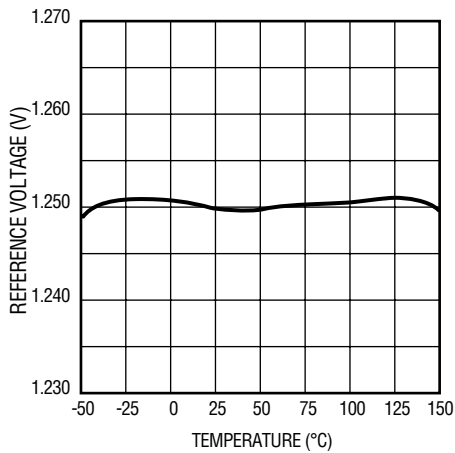

MINIMUM OPERATING CURRENT

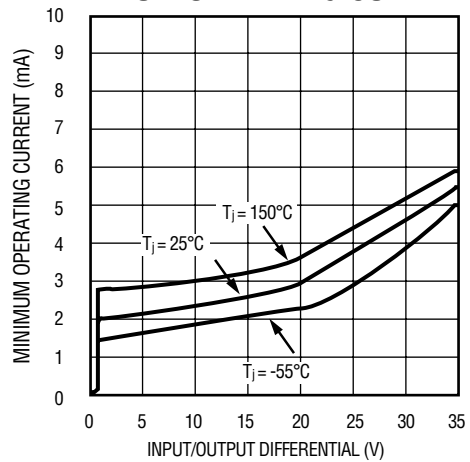

3.3

TYPICAL APPLICATIONS

Paralleling Regulators

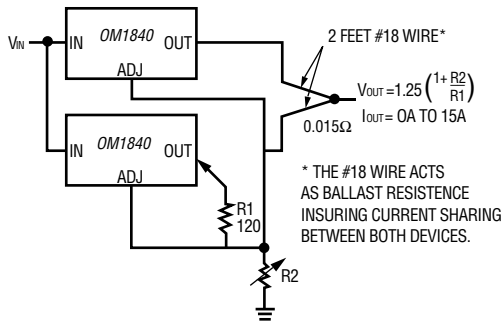

Improving Ripple Rejection

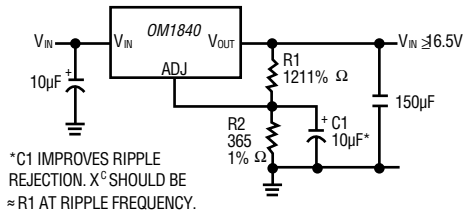

1.2V - 15V Adjustable Regulator

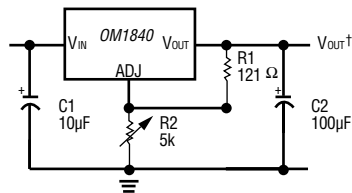

5V Regulator with Shutdown

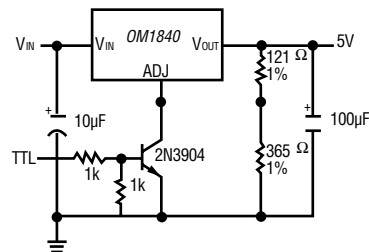

MECHANICAL OUTLINE

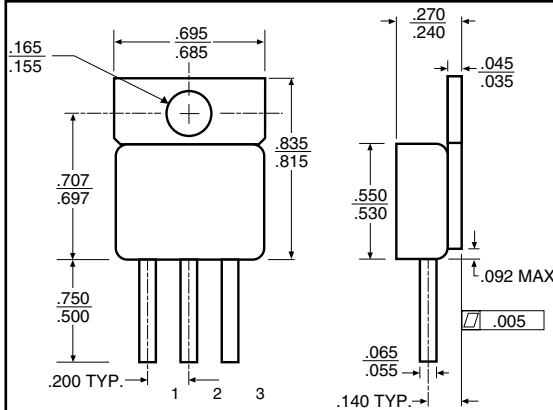

PIN OUT

1	Adjust
2	V_{OUT}
3	V_{IN}

MECHANICAL OUTLINE TO-3

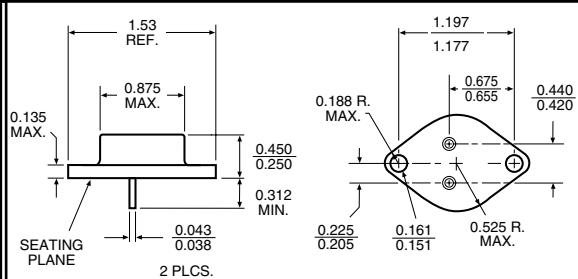

PIN OUT

1	Adjust
2	V_{IN}
Case	V_{OUT}

NOTES

- Case is metal/hermetically sealed
- Isolated Tab