

**HYBRID-HIGH RELIABILITY
RADIATION HARDENED
DC-DC CONVERTER****70V Input, Triple Output****Description**

The M3G-Series of DC-DC converters are radiation hardened, high reliability converters designed for extended operation in hostile environments. Their small size and low weight make them ideal for applications such as geostationary earth orbit satellites and deep space probes. They exhibit a high tolerance to total ionizing dose, single event effects and environmental stresses such as temperature extremes, mechanical shock, and vibration.

The converters incorporate a fixed frequency single ended forward topology with magnetic feedback and an internal EMI filter that utilizes multilayer ceramic capacitors that are subjected to extensive lot screening for optimum reliability. By using two stage filtering these converters produce low input and output noise. External inhibit and synchronization input and output allow these converters to be easily incorporated into larger power systems. They are enclosed in a hermetic 3" x 2" x 0.475" package constructed of an Aluminum-Silicon-Carbide (AlSiC) base and an Alloy 48 ring frame and they weigh less than 110 grams. The package utilizes rugged ceramic feed-through copper core pins and is sealed using parallel seam welding.

Manufactured in a facility fully qualified to MIL-PRF-38534, these converters are fabricated utilizing DLA Land and Maritime qualified processes. For available screening options, refer to device screening table in the data sheet.

Non-flight versions of the M3G-Series converters are available for system development purposes. Variations in electrical specifications and screening to meet custom requirements can be accommodated.

**Features**

- Total Dose > 200 kRads(Si)
typically usable to > 300 kRads(Si)
- SEE Hardened to LET up to 82 MeV.cm²/mg
- Low Input & Output Noise
- Low Weight < 110 grams
- Magnetically Coupled Feedback
- 60V to 120V DC Input Range
- Up to 40W Output Power
- Triple Output Models Include
+5V and ±12V or ±15V
- Main Output Isolated from Dual Outputs
- High Efficiency - to 82%
- -55°C to +125°C Operating Temperature Range
- 100MΩ @ 500VDC Isolation
- Under-Voltage Lockout
- Synchronization Input and Output
- Short Circuit and Overload Protection
- Output Over Voltage Limiter
- External Inhibit
- > 5,000,000 hour MTBF

Applications

- Geostationary Earth Orbit Satellites (GEO)
- Deep Space Satellites / Probes
- Strategic Weapons and Communication System

Circuit Description

The M3G-Series converters utilize a single-ended forward topology with resonant reset. The nominal switching frequency is 500 kHz. Electrical isolation and tight output regulation are achieved through the use of a magnetically coupled feedback. Voltage feed-forward with duty factor limiting provides high line rejection.

An internal EMI filter reduces the conducted emissions to less than 5mArms on the input power leads. A two stage output filter reduces the typical output ripple to less than 20mV peak-to-peak.

The main (+5 volt) output is regulated by the control loop and typically exhibits better than 1% regulation. The auxiliary (± 12 volt or ± 15 volt) outputs are maintained through tight coupling in the power transformer and main output filter inductor and typically exhibit better than 5% regulation. The main output and auxiliary outputs are isolated from each other.

Output current is limited under any load fault condition to approximately 125% of rated. An overload condition causes the converter output to behave like a constant current source with the output voltage dropping below nominal. The converter will resume normal operation when the load current is reduced below the current limit point. This protects the converter from both overload and short circuit conditions. The current limit point exhibits a slightly negative temperature coefficient to reduce the possibility of thermal runaway.

An under-voltage lockout circuit prohibits the converter from operating when the line voltage is too low to maintain the output voltage. The converter will not start until the line voltage rises to approximately 58 volts and will shut down when the input voltage drops 54 volts. The four volt of hysteresis reduces the possibility of line noise interfering with the converter's start-up and shut down.

An external inhibit port is provided to control converter operation. The nominal threshold relative to the input return (pin 2) is 1.4V. If 2.0 volts or greater are applied to the Inhibit pin (pin 3) then the converter will operate normally. A voltage of 0.8V or less will cause the converter to shut-down. The pin may be left open for normal operation and has a nominal open circuit voltage of 4.0V.

Synchronization input and output allow multiple converters to operate at a common switching frequency. Converters can be synchronized to one another or to an externally provided clock. This can be used to eliminate beat frequency noise or to avoid creating noise at certain frequencies for sensitive systems.

Design Methodology

The M3G-Series was developed using a proven conservative design methodology which includes selecting radiation tolerant and established reliability components and fully de-rating to the requirements of MIL-STD-975 and MIL-STD-1547 except for the CDR type ceramic capacitors, a capacitor with 50V rating is used for in-circuit voltage stress of less than 10V. Careful sizing of decoupling capacitors and current limiting resistors minimizes the possibility of photo-current burn-out. Heavy de-rating of the radiation hardened power MOSFET virtually eliminates the possibility of SEGR and SEB. A magnetic feedback circuit is utilized instead of opto-couplers to minimize temperature, radiation and aging sensitivity. PSPICE and Rad SPICE were used extensively to predict and optimize circuit performance for both beginning and end-of-life. Thorough design analyses include Radiation Susceptibility (TREE), Worst Case, Stress, Thermal, Failure Modes and Effects (FMEA) and Reliability (MTBF).

Specifications

Absolute Maximum Ratings		Recommended Operating Conditions	
Input voltage range	-0.5V _{DC} to +150V _{DC}	Input voltage range	+60V _{DC} to +120V _{DC}
Output power	Internally limited	Input voltage range ¹	+60V _{DC} to +100V _{DC}
Lead temperature	+300°C for 10 seconds	Output power	0 to Max. Rated
Operating temperature	-55°C to +135°C	Operating temperature ²	-55°C to +125°C
Storage temperature	-55°C to +135°C	Operating temperature ¹	-55°C to +70°C

¹ Meets de-rating per MIL-STD-975

² For operation at +125°C see table note 15

Electrical Performance Characteristics

Parameter	Group A Subgroup	Conditions -55°C ≤ T _C ≤ +85°C V _{IN} = 70V DC ± 5%, C _L = 0 unless otherwise specified	Limits			Unit
			Min	Nom	Max	
Input voltage	1,2,3	Note 2	60	70	100	V
Output voltage (V _{OUT}) (main) M3G700512T (aux.) M3G700515T (aux.)	1	I _{OUT} = 100% rated load, Note 5	4.98 ±11.50 ±14.60	5.00 ±11.80 ±14.90	5.02 ±12.10 ±15.20	V
(main) M3G700512T (aux.) M3G700515T (aux.)	2,3		4.93 ±11.30 ±14.40		5.07 ±12.30 ±15.40	
Output power (P _{OUT})	1,2,3	V _{IN} = 60, 70, 100 Volts, Note 2	0		40	W
Output current (I _{OUT}) (main) M3G700512T (aux.) M3G700515T (aux.)	1,2,3	V _{IN} = 60, 70, 100 Volts, Notes 2,3,4,5	400 83 67		4000 ±833 ±667	mA
Line regulation (VR _{LINE}) (main) M3G700512T (aux.) M3G700515T (aux.)	1,2,3	V _{IN} = 60, 70, 100 Volts I _{OUT} = 10%, 50%, 100% rated Note 5, 14	-10 -120 -150		10 120 150	mV
Load regulation (VR _{LOAD}) (main) M3G700512T (aux.) M3G700515T (aux.)	1,2,3	I _{OUT} = 10%, 50%, 100% rated V _{IN} = 60, 70, 100 Volts Notes 5,13	-50 -400 -500		50 400 500	mV
Cross regulation (VR _{CROSS}) M3G700512T (aux.) M3G700515T (aux.)	1,2,3	V _{IN} = 60, 70, 100 Volts I _{OUT} = 2.5A to 1A and 2.5A to 4A on main and ±half rated on aux. outputs	-3.5 -3.0		3.5 3.0	%
Input current (I _{IN})	1,2,3	I _{OUT} = 0, Pin 3 open Pin 3 shorted to pin 2		35 2.0	50 5.0	mA
Output ripple (V _{RIP}) (main) 700512T (aux.) 700515T (aux.)	1,2,3	V _{IN} = 60, 70, 100 Volts		25 30 30	50 60 75	mVp-p
Switching frequency (F _S)	1,2,3	Sync. Input (Pin 4) open	450	500	550	kHz

For Notes to Electrical Performance Characteristics, refer to page 5

Electrical Performance Characteristics (continued)

Parameter	Group A Subgroup	Conditions -55°C ≤ T _C ≤ +85°C V _{IN} = 70V DC ± 5%, C _L = 0 unless otherwise specified	Limits			Unit
			Min	Nom	Max	
Efficiency (E _{FF})	1,2,3	I _{OUT} = 100% rated load Note 5	78	82		%
Inhibit input open circuit voltage drive current (sink) voltage range		Note 1	3.0 -0.5		5.0 100 50	V μA V
Synchronization input frequency range pulse high level pulse low level pulse transition time pulse duty cycle		Ext. Clock on Sync. Input (Pin 4) Note 1	450 4.0 -0.5 40 20		600 10.0 0.5 80	kHz V V V/μs %
Current limit point Expressed as a percentage of full rated output power	1,2,3	V _{OUT} = 90% of Nominal, Note 5			135	%
Power dissipation, load fault (P _D)	1,2,3	Short Circuit, Overload, Note 8			18	W
Output response to step load changes (V _{TLD})	4,5,6	Half Load to/from Full Load, Notes 5,9	-300		300	mVpk
Recovery time, step load changes (T _{TLD})	4,5,6	Half Load to/from Full Load, Note 5,9,10		50	200	μs
Output response to step line changes (V _{TLN})		60V to/from 100V I _{OUT} = 100% rated load, Notes 1, 5, 11	-300		300	mVpk
Recovery time, step line changes (T _{TLN})		60V to/from 100V I _{OUT} = 100% rated load, Notes 1, 5, 10, 11		50	200	μs
Turn-on response Overshoot (V _{OS}) (main) (aux.) Turn-on delay (T _{DLY})	4,5,6	No Load, Full Load Notes 5, 12	1.0		500 750 5.0	mV mV ms
Capacitive load (C _L) (main) (Each aux. output)		I _{OUT} = 100% rated load, No effect on DC performance, Notes 1, 5, 7			1000 200	μF
Line rejection		DC to 50 kHz, Notes 1, 5 I _{OUT} = 100% rated load	40	60		dB
Isolation	1	Input to Output or Any Pin to Case except pin 10, test @ 500VDC	100			MΩ
Device weight					110	g
MTBF		MIL-HDBK-217F2, SF, 35°C	5 x 10 ⁶			Hrs

For Notes to Electrical Performance Characteristics, refer to page 5

Notes: Electrical Performance Characteristics Table

1. Parameter is tested as part of design characterization or after design changes. Thereafter, parameter shall be guaranteed to the limits specified..
2. Parameter verified during line and load regulation tests.
3. Although operation with no load is permissible, light loading on the main (+5 volt) output may cause the output voltage of the auxiliary outputs (± 12 volt or ± 15 volt) to drop out of regulation. It is therefore recommended that at least 200 mA or 20 percent of the total output power, whichever is greater, be taken from the main (+5 volt) output.
4. Although operation with no load is permissible, heavy loading on the main (+5 volt) output may cause the output voltage of the auxiliary outputs (± 12 volt or ± 15 volt) to rise out of regulation. It is therefore recommended that at least 50 mA or 20 percent of the total output power, whichever is greater, be taken from the auxiliary (± 12 volt or ± 15 volt) outputs.
5. Unless otherwise specified, "Rated" load is 20W on the main (+5 volt) output and 10 watts each on the auxiliary (± 12 volt or ± 15 volt) outputs. Load currents of up to 5A and $\pm 1A$ on the main and auxiliary outputs respectively are acceptable as long as the total output power does not to exceed 40 watts.
6. Guaranteed for a D.C. to 20 MHz bandwidth. Tested using a 20 kHz to 10 MHz bandwidth.
7. Capacitive load may be any value from 0 to the maximum limit without compromising dc performance. A capacitive load in excess of the maximum limit may interfere with the proper operation of the converter's overload protection, causing erratic behavior during turn-on.
8. Overload power dissipation is defined as the device power dissipation with the load set such that $V_{OUT} = 90\%$ of nominal.
9. Load step transition time $\geq 10 \mu s$.
10. Recovery time is measured from the initiation of the transient to where V_{OUT} has returned to within $\pm 1\%$ of its steady state value.
11. Line step transition time $\geq 100 \mu s$.
12. Turn-on delay time from either a step application of input power or a logic low to a logic high transition on the inhibit pin(pin3 to the point where $V_{OUT} = 90\%$ of nominal.
13. Load Regulation relative to output voltage at 50% rated load.
14. Line Regulation relative to output voltage at 70Vdc input.
15. Although operation at temperatures between $+85^{\circ}C$ and $+125^{\circ}C$ is guaranteed, no parametric limits are specified.

Radiation Performance Characteristics

Test	Conditions	Min	Typ	Unit
Total Ionizing Dose (Gamma)	MIL-STD-883, Method 1019 Operating bias applied during exposure, Full Rated Load, $V_{IN} = 70V$	200	300	kRads (Si)
Dose Rate (Gamma Dot) Temporary Saturation Survival	MIL-STD-883, Method 1023 Operating bias applied during exposure, Full Rated Load, $V_{IN} = 70V$	1E8 4E10	1E11	Rads (Si)/sec
Neutron Fluence	MIL-STD-883, Method 1017	8E12	1E13	Neutrons/cm ²
Single Event Effects SEU, SEL, SEGR, SEB	Heavy ions (LET) Operating bias applied during exposure, Full Rated Load, $V_{IN} = 70V$ Test lab: Brookhaven National Laboratory, Tandem Van de Graaff Generator	82		MeV.cm ² /mg

IR HiRel currently does not have a DLA Land and Maritime certified Radiation Hardness Assurance Program.

Fig 1. Block Diagram - Triple Output

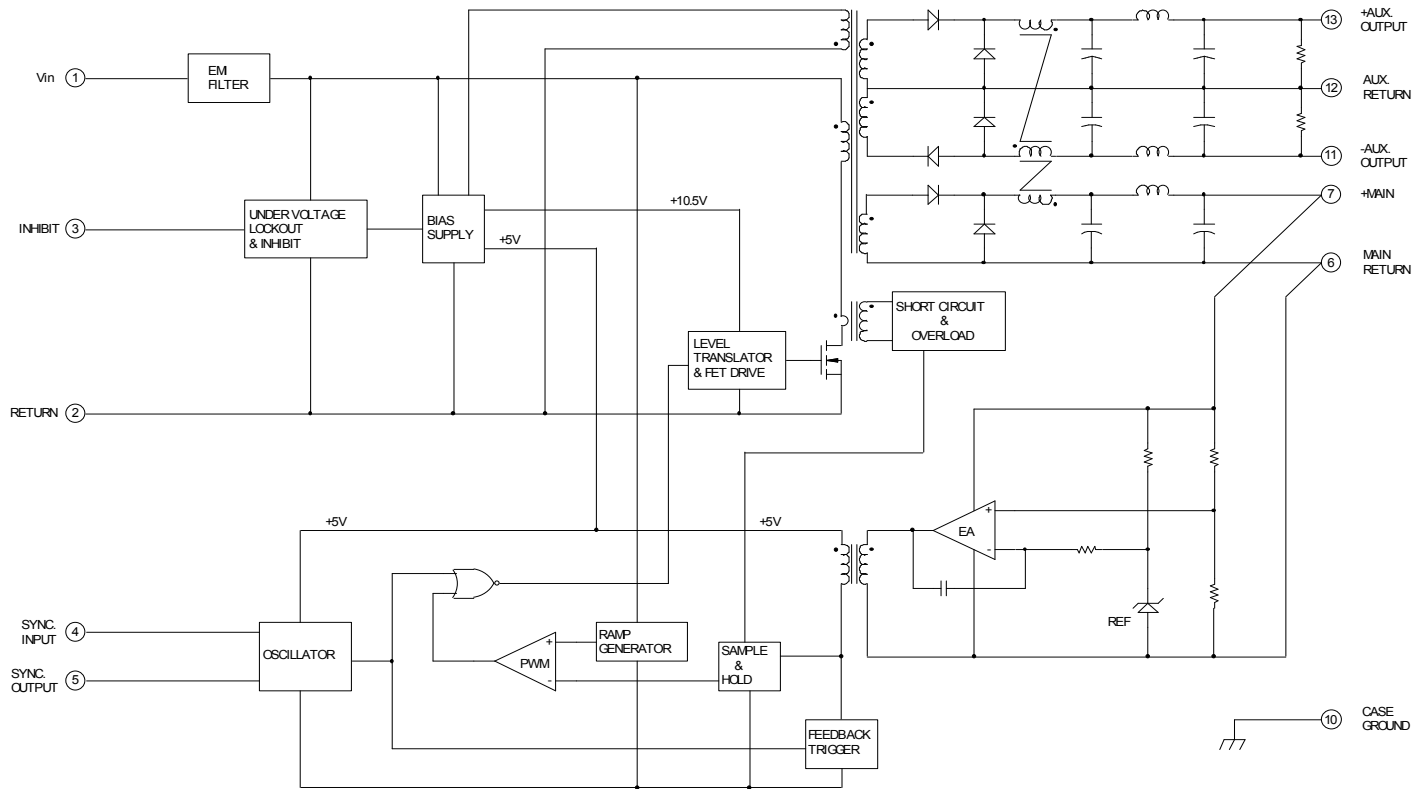

Fig 2. $\pm 12V$ Load Regulation vs 5V Load

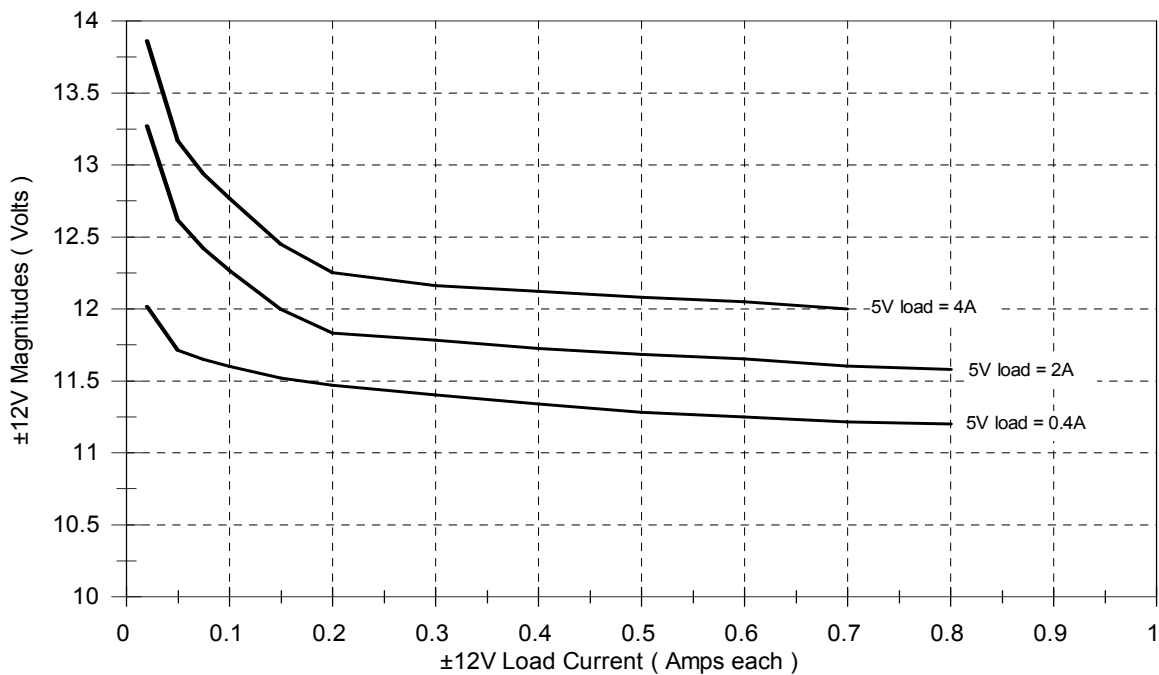

Fig 3. $\pm 15V$ Load Regulation vs 5V Load

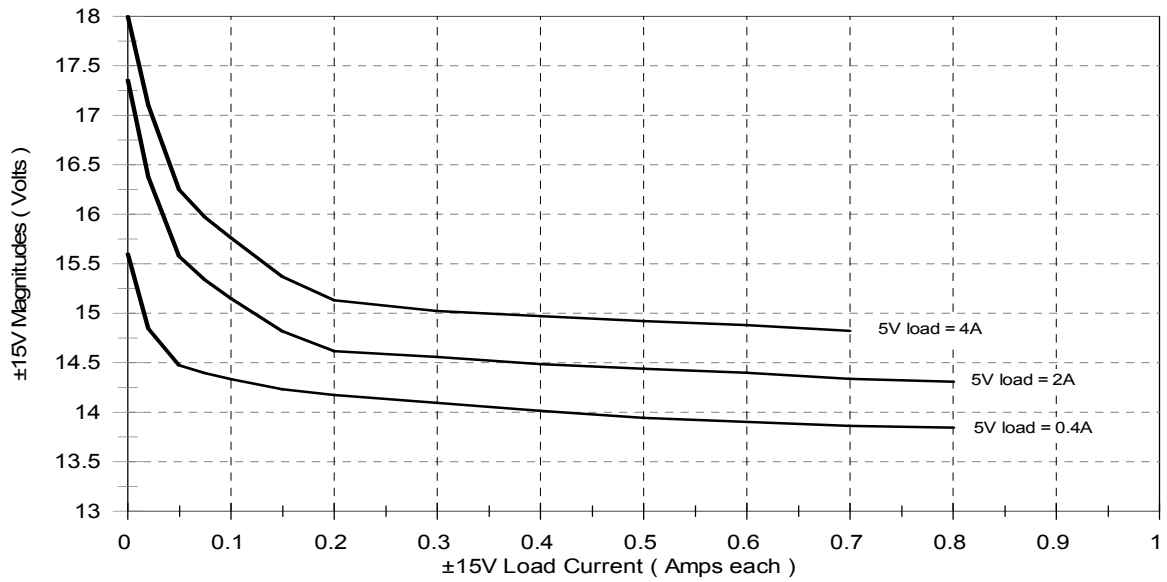

Fig 4. Line Rejection, Main Output

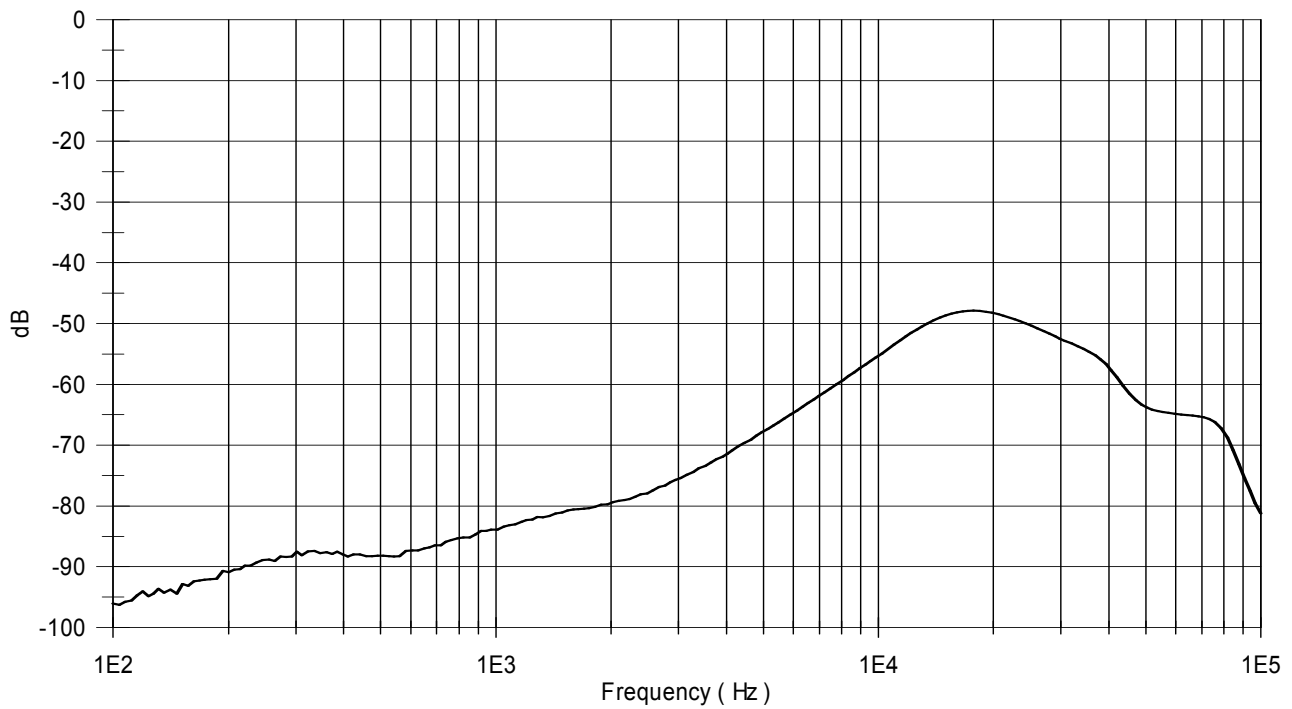

Fig 5. Line Rejection, Aux. Outputs

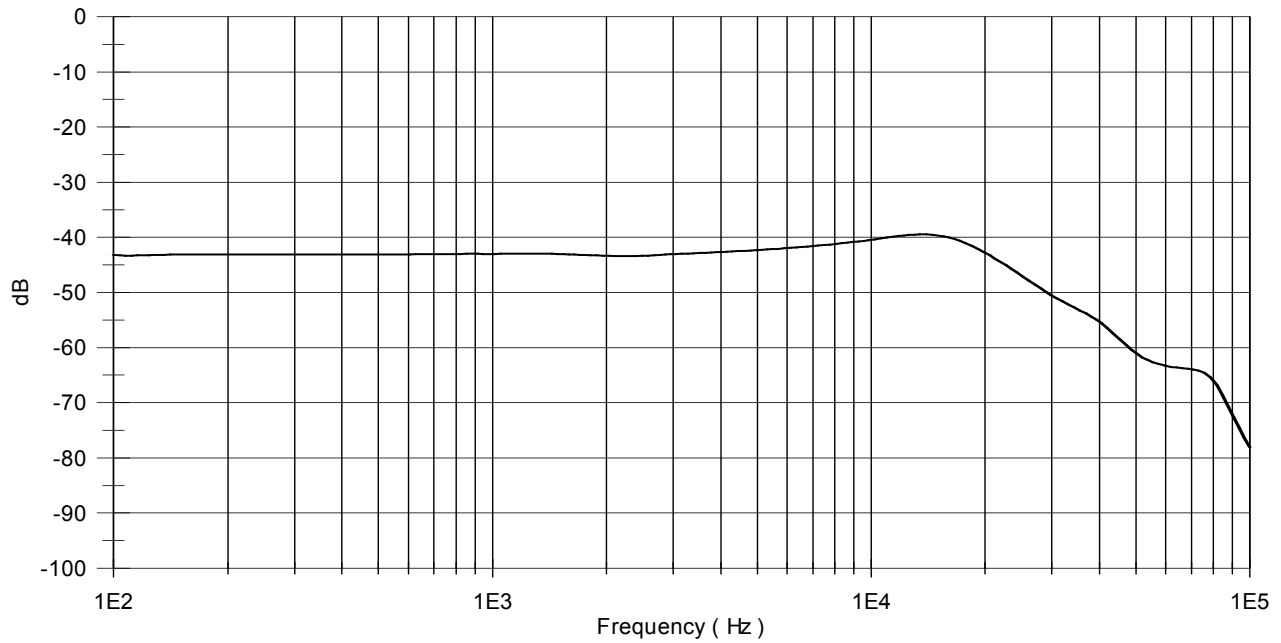

Fig 6. Conducted Emissions, Normal Mode

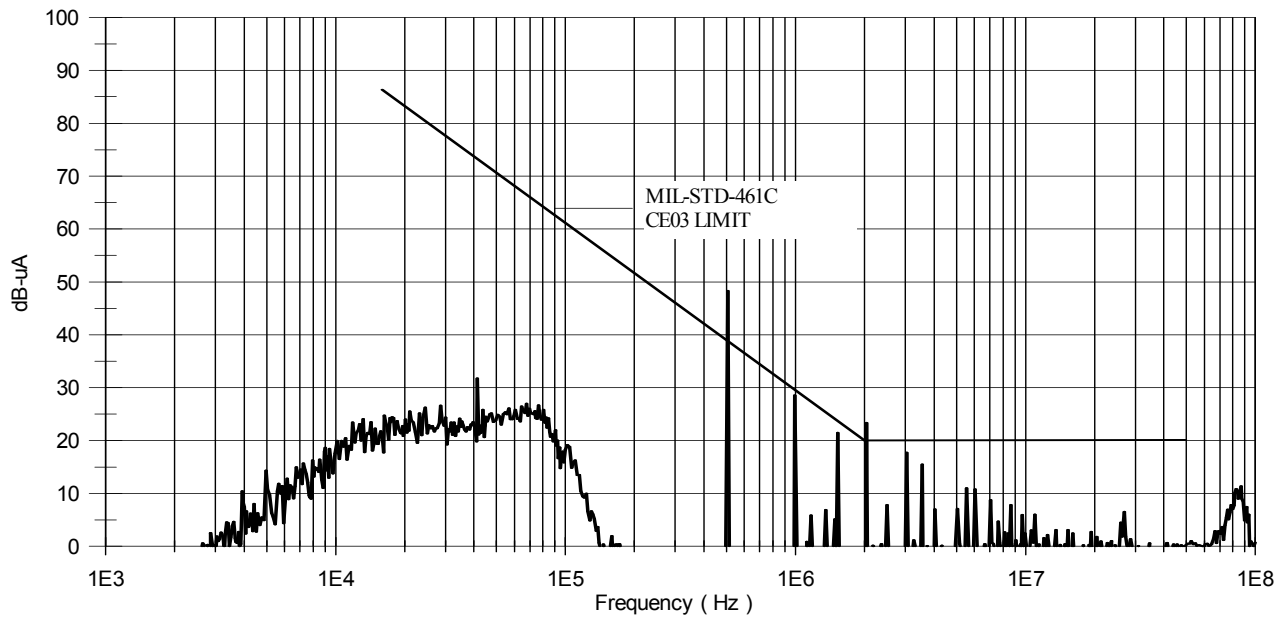
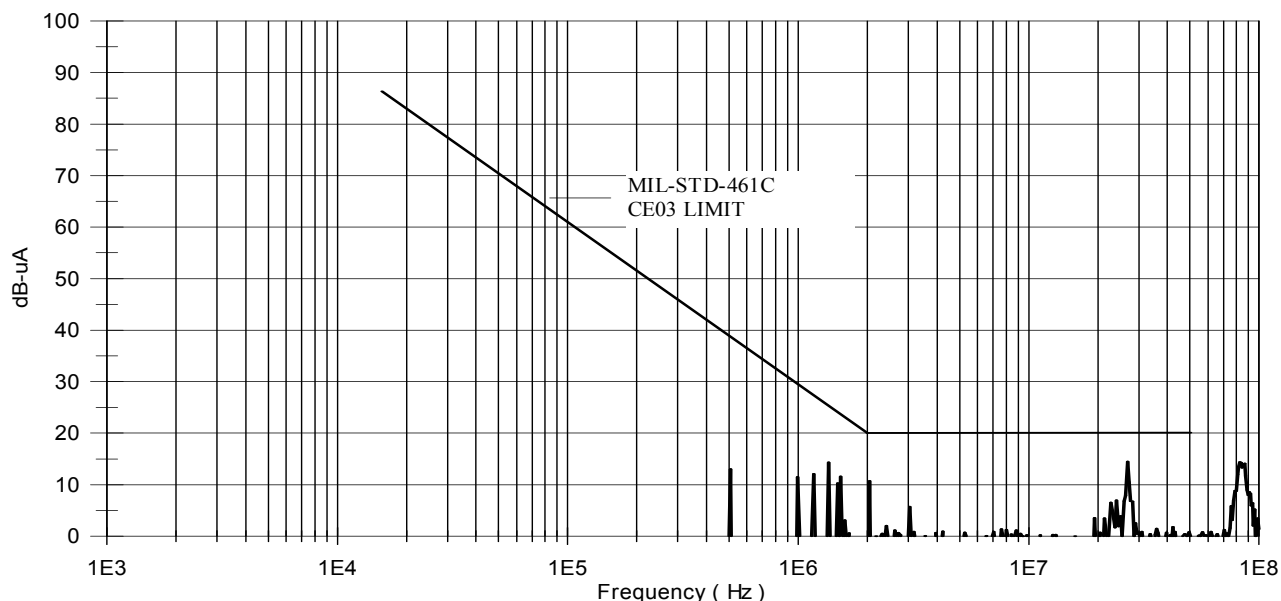

Fig 7. Conducted Emissions, Common Mode



Application Notes

A) Attachment of the Converter:

The following procedure is recommended for mounting the converter for optimum cooling and to circumvent any potential damage to the converter.

Ensure that flatness of the plate where M3G converter to be mounted is no greater than 0.003" per linear inch. It is recommended that a thermally conductive gasket is used to promote the thermal transfer and to fill any voids existing between the two surfaces. IR HiRel recommends Sil-Pad 2000 with the thickness of 0.010". The shape of the gasket should match the footprint of the converter including the mounting flanges. The gasket is available from IR HiRel. The M3G-Series converter requires either M3 or 4-40 size screws for attachment purposes.

The procedure for mounting the converter is as follows

1. Check the mounting surfaces and remove foreign material, burrs if any or anything that may interfere with the attachment of the converter.
2. Place the gasket on the surface reserved for the converter and line it up with the mounting holes.
3. Place the converter on the gasket and line both up with mounting holes.
4. Install screws using appropriate washers and tighten by hand (~ 4 in·oz) in the sequence shown below.

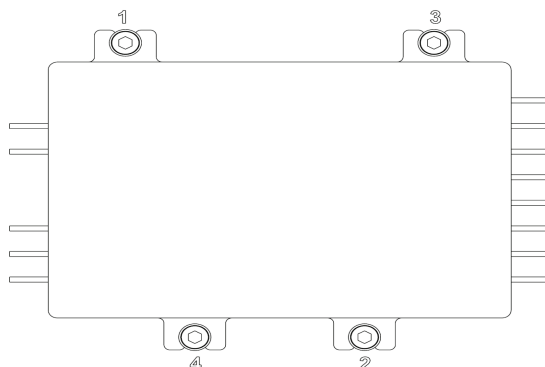

5. Tighten the screws with an appropriate torque driver. Torque the screws up to 6 in·lb in the sequence shown above.

Mechanical Outline

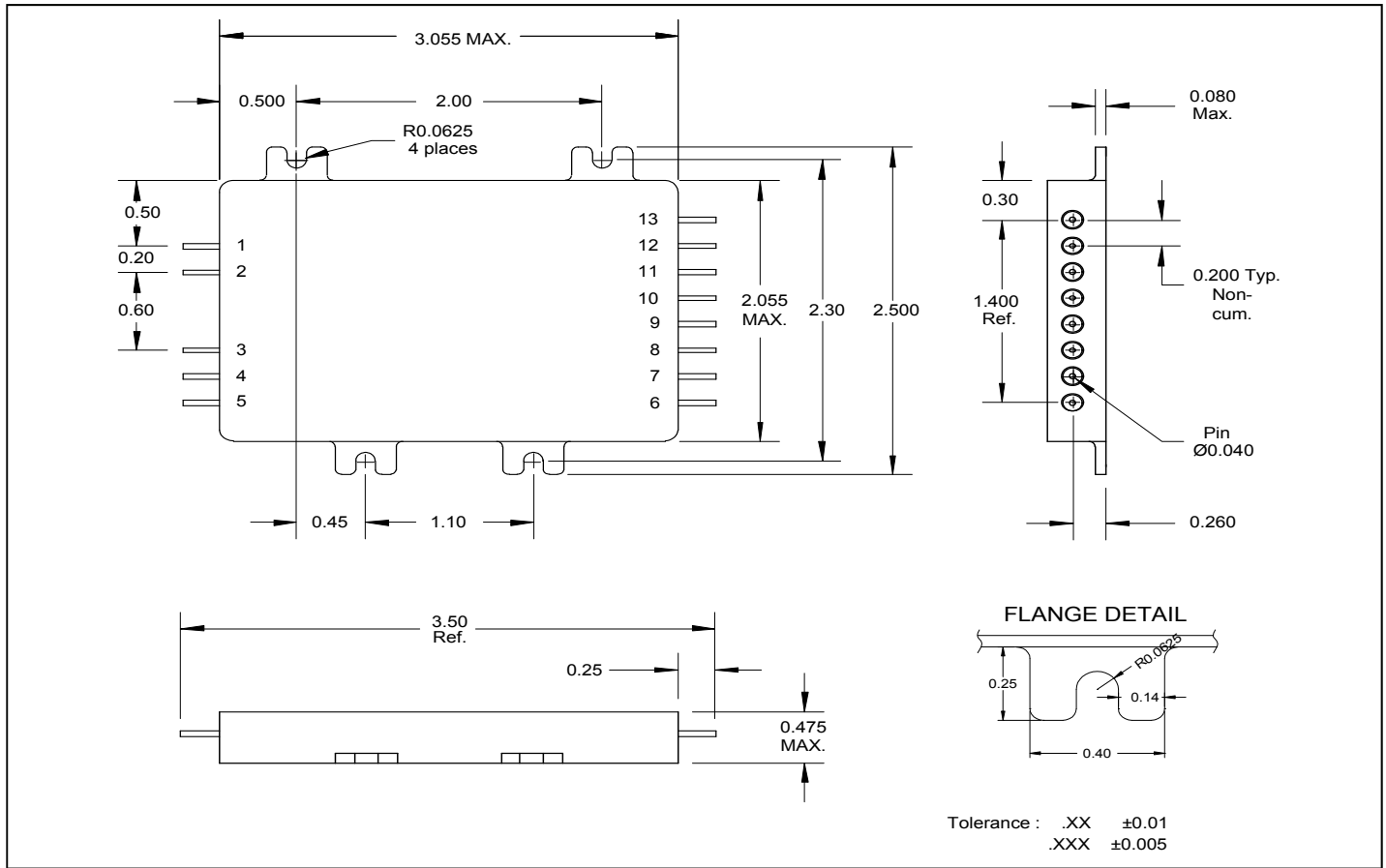

Pin Designation

Pin #	Designation	Pin #	Designation
1	+ Input	8	NC
2	Input Return	9	NC
3	Inhibit	10	Case Ground
4	Sync. Input	11	- Aux. Output
5	Sync. Output	12	Aux. Output Return
6	Main Return	13	+ Aux. Output
7	+ Main Output		

Device Screening

Requirement	MIL-STD-883 Method	No Suffix ②	CK ②	EM ③
Temperature Range	—	-55°C to +85°C	-55°C to +85°C	-55°C to +85°C
Element Evaluation	MIL-PRF-38534	Class K	Class K	N/A
Non-Destructive Bond Pull	2023	Yes	Yes	N/A
Internal Visual	2017	Yes	Yes	①
Temperature Cycle	1010	Cond C	Cond C	Cond C
Constant Acceleration	2001, Y1 Axis	3000 Gs	3000 Gs	3000 Gs
PIND	2020	Cond A	Cond A	N/A
Burn-In	1015	320 hrs @ 125°C (2 x 160 hrs)	320 hrs @ 125°C (2 x 160 hrs)	48 hrs @ 125°C
Final Electrical (Group A)	MIL-PRF-38534 & Specification	-55°C, +25°C, +85°C	-55°C, +25°C, +85°C	-55°C, +25°C, +85°C
PDA	MIL-PRF-38534	2%	2%	N/A
Seal, Fine and Gross	1014	Cond A, C	Cond A, C	Cond A
Radiographic	2012	Yes	Yes	N/A
External Visual	2009	Yes	Yes	①

Notes:

- ① Best commercial practice.
- ② CK is a DLA Land and Maritime (formerly DSCC) part marking used to designate a Class K compliant hybrid. The CK marking does not indicate the hybrid is radiation certified. No Suffix is a radiation rated device but not available as a DLA Land and Maritime qualified SMD per MIL-PRF-38534.
- ③ Any Engineering Model (EM) build with the “EM” Suffix shall only be form, fit and functional equivalent to its Flight Model (FM) counterpart, and it may not meet the radiation performance. The EM Model shall not be expected comply with MIL-PRF-38534 flight quality/workmanship standards, and configuration control. An EM build may use electrical equivalent commercial grade components. IR HiRel will provide a list of non-compliance items upon request.

Part Numbering

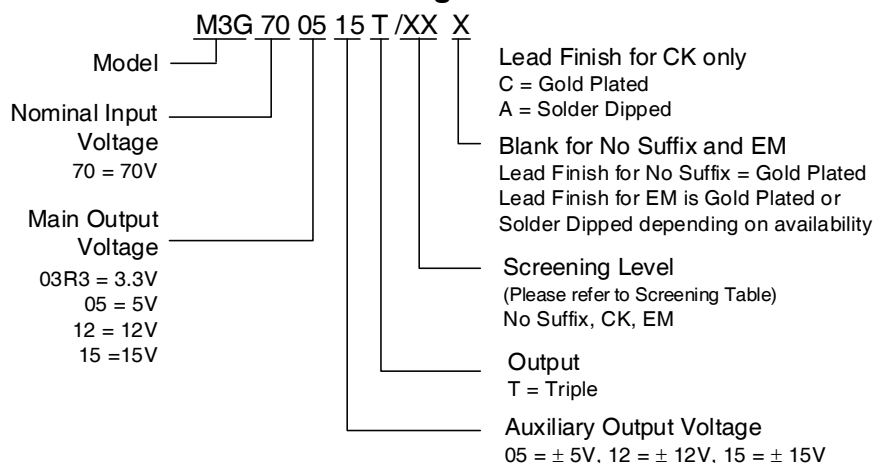

IMPORTANT NOTICE

The information given in this document shall be in no event regarded as guarantee of conditions or characteristic. The data contained herein is a characterization of the component based on internal standards and is intended to demonstrate and provide guidance for typical part performance. It will require further evaluation, qualification and analysis to determine suitability in the application environment to confirm compliance to your system requirements.

With respect to any example hints or any typical values stated herein and/or any information regarding the application of the product, Infineon Technologies hereby disclaims any and all warranties and liabilities of any kind including without limitation warranties on non- infringement of intellectual property rights and any third party.

In addition, any information given in this document is subject to customer's compliance with its obligations stated in this document and any applicable legal requirements, norms and standards concerning customer's product and any use of the product of Infineon Technologies in customer's applications.

The data contained in this document is exclusively intended for technically trained staff. It is the responsibility of any customer's technical departments to evaluate the suitability of the product for the intended applications and the completeness of the product information given in this document with respect to applications.

For further information on the product, technology, delivery terms and conditions and prices, please contact your local sales representative or go to (www.infineon.com/hirel).

WARNING

Due to technical requirements products may contain dangerous substances. For information on the types in question, please contact your nearest Infineon Technologies office.