

COM140T COM340T
COM240T COM440T

(COTS) COMMERCIAL OFF-THE-SHELF POWER MOSFETS IN TO-257AA PACKAGE

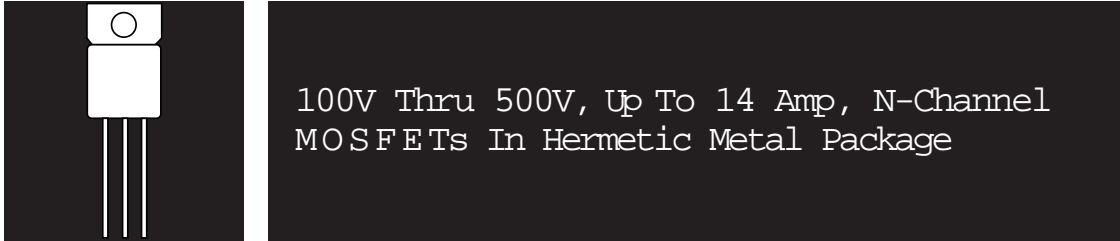

FEATURES

- Isolated Hermetic Metal Package
- Fast Switching
- Low $R_{DS(on)}$

DESCRIPTION

This series of hermetically packaged products feature the latest advanced MOS-FET and packaging technology. They are ideally suited for Military requirements where small size, high performance and high reliability are required, and in applications such as switching power supplies, motor controls, inverters, choppers, audio amplifiers and high energy pulse circuits.

MAXIMUM RATINGS @ 25°C

PART NUMBER	V_{DS}	$R_{DS(on)}$	$I_D(MAX)$
COM140T	100V	.12	14A
COM240T	200V	.21	14A
COM340T	400V	.59	10A
COM440T	500V	.90	7A

3.1

SCHEMATIC

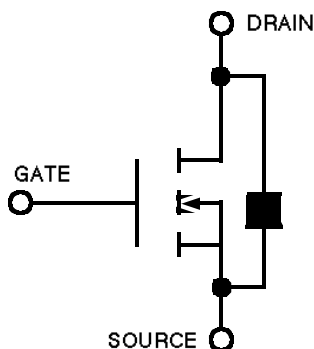

CONNECTION DIAGRAM

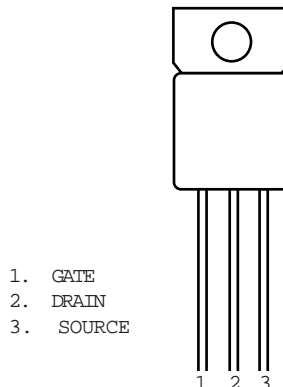

ELECTRICAL CHARACTERISTICS: $T_C = 25^\circ$ unless otherwise noted
STATIC P/N COM140T

ELECTRICAL CHARACTERISTICS: $T_C = 25^\circ$ unless otherwise noted
STATIC P/N COM240T

Parameter	Min.	Typ.	Max.	Units	Test Conditions
BV_{DSS} Drain-Source Breakdown Voltage	100			V	$V_{GS} = 0,$ $I_D = 250$ mA
$V_{GS(th)}$ Gate-Threshold Voltage	2.0		4.0	V	$V_{DS} = V_{GS}, I_D = 250$ mA
I_{GSSF} Gate-Body Leakage Forward			100	nA	$V_{GS} = 20$ V
I_{GSSR} Gate-Body Leakage Reverse			-100	nA	$V_{GS} = -20$ V
I_{GSS} Zero Gate Voltage Drain Current		0.1 0.2	0.25 1.0	mA	$V_{DS} = \text{Max. Rat.}, V_{GS} = 0$ $V_{DS} = 0.8 \text{ Max. Rat.}, V_{GS} = 0,$ $T_C = 125^\circ$ C
$I_{D(on)}$ On-State Drain Current ¹	14			A	$V_{DS} = 2 V_{DS(on)}, V_{GS} = 10$ V
$V_{DS(on)}$ Static Drain-Source On-State Voltage ¹		1.40	1.73	V	$V_{GS} = 10$ V, $I_D = 15$ A
$R_{DS(on)}$ Static Drain-Source On-State Resistance ¹			.12		$V_{GS} = 10$ V, $I_D = 15$ A
$R_{DS(on)}$ Static Drain-Source On-State Resistance ¹			.22		$V_{GS} = 10$ V, $I_D = 15$ A, $T_C = 125$ C

Parameter	Min.	Typ.	Max.	Units	Test Conditions
BV_{DSS} Drain-Source Breakdown Voltage	200			V	$V_{GS} = 0,$ $I_D = 250$ mA
$V_{GS(th)}$ Gate-Threshold Voltage	2.0		4.0	V	$V_{DS} = V_{GS}, I_D = 250$ mA
I_{GSSF} Gate-Body Leakage Forward			100	nA	$V_{GS} = 20$ V
I_{GSSR} Gate-Body Leakage Reverse			-100	nA	$V_{GS} = -20$ V
I_{GSS} Zero Gate Voltage Drain Current		0.1 0.2	0.25 1.0	mA	$V_{DS} = \text{Max. Rat.}, V_{GS} = 0$ $V_{DS} = 0.8 \text{ Max. Rat.}, V_{GS} = 0,$ $T_C = 125^\circ$ C
$I_{D(on)}$ On-State Drain Current ¹	14			A	$V_{DS} = 2 V_{DS(on)}, V_{GS} = 10$ V
$V_{DS(on)}$ Static Drain-Source On-State Voltage ¹		1.8	2.1	V	$V_{GS} = 10$ V, $I_D = 10$ A
$R_{DS(on)}$ Static Drain-Source On-State Resistance ¹			0.21		$V_{GS} = 10$ V, $I_D = 10$ A
$R_{DS(on)}$ Static Drain-Source On-State Resistance ¹			0.41		$V_{GS} = 10$ V, $I_D = 10$ A, $T_C = 125$ C

DYNAMIC

DYNAMIC

Parameter	Min.	Typ.	Max.	Units	Test Conditions
g_B Forward Transconductance ¹	10			S (M)	$V_{DS} = 2 V_{DS(on)}, I_D = 15$ A
C_{iss} Input Capacitance		1275		pF	$V_{GS} = 0$
C_{oss} Output Capacitance		550		pF	$V_{DS} = 25$ V
C_{rss} Reverse Transfer Capacitance		160		pF	$f = 1$ MHz
$T_{d(on)}$ Turn-On Delay Time		16		ns	$V_{DD} = 30$ V, $I_D @ 5$ A
t_r Rise Time		19		ns	$R_g = 5$ W, $V_{GS} = 10$ V
$T_{d(off)}$ Turn-Off Delay Time		42		ns	(MOSFET) switching times are essentially independent of operating temperature.
t_f Fall Time		24		ns	

Parameter	Min.	Typ.	Max.	Units	Test Conditions
g_B Forward Transconductance ¹	6.0			S (M)	$V_{DS} = 2 V_{DS(on)}, I_D = 10$ A
C_{iss} Input Capacitance		1000		pF	$V_{GS} = 0$
C_{oss} Output Capacitance		250		pF	$V_{DS} = 25$ V
C_{rss} Reverse Transfer Capacitance		100		pF	$f = 1$ MHz
$T_{d(on)}$ Turn-On Delay Time		17		ns	$V_{DD} = 75$ V, $I_D @ 18$ A
t_r Rise Time		52		ns	$R_g = 5$ W, $V_{GS} = 10$ V
$T_{d(off)}$ Turn-Off Delay Time		36		ns	(MOSFET) switching times are essentially independent of operating temperature.
t_f Fall Time		30		ns	

BODY-DRAIN DIODE RATINGS AND CHARACTERISTICS

BODY-DRAIN DIODE RATINGS AND CHARACTERISTICS

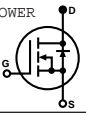
I_S Continuous Source Current (Body Diode)			-27	A	Modified MOSPOWER symbol showing the integral P-N Junction rectifier. 
I_{SM} Source Current ¹ (Body Diode)			-108	A	
V_{SD} Diode Forward Voltage ¹			-2.0	V	$T_C = 25$ C, $I_S = -24$ A, $V_{GS} = 0$
t_r Reverse Recovery Time		200		ns	$T_J = 150$ C, $I_F = I_S,$ $d_f/ds = 100$ A/ms

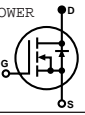
I_S Continuous Source Current (Body Diode)			-18	A	Modified MOSPOWER symbol showing the integral P-N Junction rectifier. 
I_{SM} Source Current ¹ (Body Diode)			-72	A	
V_{SD} Diode Forward Voltage ¹			-1.5	V	$T_C = 25$ C, $I_S = -18$ A, $V_{GS} = 0$
t_r Reverse Recovery Time		350		ns	$T_J = 150$ C, $I_F = I_S,$ $d_f/ds = 100$ A/ms

¹ Pulse Test: Pulse Width 300msec, Duty Cycle 2%.

¹ Pulse Test: Pulse Width 300msec, Duty Cycle 2%.

ELECTRICAL CHARACTERISTICS: $T_C = 25^\circ$ unless otherwise noted
 STATIC P/N COM340T

Parameter	Min.	Typ.	Max.	Units	Test Conditions
BV_{DSS} Drain-Source Breakdown Voltage	400			V	$V_{GS} = 0$, $I_D = 250$ mA
$V_{GS(th)}$ Gate-Threshold Voltage	2.0		4.0	V	$V_{DS} = V_{GS}$, $I_D = 250$ mA
I_{SSF} Gate-Body Leakage Forward			100	nA	$V_{GS} = 20$ V
I_{SSR} Gate-Body Leakage Reverse			-100	nA	$V_{GS} = -20$ V
I_{SS} Zero Gate Voltage Drain Current		0.1 0.2	0.25 1.0	m A	$V_{DS} = \text{Max. Rat.}$, $V_{GS} = 0$ $V_{DS} = 0.8 \text{ Max. Rat.}$, $V_{GS} = 0$, $T_C = 125^\circ$ C
$I_{D(on)}$ On-State Drain Current ¹	10			A	$V_{DS} = 2 V_{DS(on)}$, $V_{GS} = 10$ V
$V_{DS(on)}$ Static Drain-Source On-State Voltage ¹		2.5	2.9	V	$V_{GS} = 10$ V, $I_D = 5$ A
$R_{DS(on)}$ Static Drain-Source On-State Resistance ¹			0.59		$V_{GS} = 10$ V, $I_D = 5$ A
$R_{DS(on)}$ Static Drain-Source On-State Resistance ¹			1.2		$V_{GS} = 10$ V, $I_D = 5$ A, $T_C = 125$ C

DYNAMIC

g_b Forward Transconductance ¹	4.0	4.4		S(M)	$V_{DS} = 2 V_{DS(on)}$, $I_D = 5$ A
C_{iss} Input Capacitance		1150		pF	$V_{GS} = 0$
C_{oss} Output Capacitance		165		pF	$V_{DS} = 25$ V
C_{rss} Reverse Transfer Capacitance		70		pF	$f = 1$ MHz
$T_{d(on)}$ Turn-On Delay Time		17		ns	$V_{DD} = 175$ V, $I_D = 5$ A
t_r Rise Time		12		ns	$R_g = 5$ W, $V_{DS} = 10$ V
$T_{d(off)}$ Turn-Off Delay Time		45		ns	
t_f Fall Time		30		ns	

BODY-DRAIN DIODE RATINGS AND CHARACTERISTICS

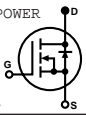
I_S Continuous Source Current (Body Diode)			-10	A	Modified MOSPOWER symbol showing the integral P-N Junction rectifier. 
I_{SM} Source Current ¹ (Body Diode)			-40	A	
V_{SD} Diode Forward Voltage ¹			-2	V	$T_C = 25$ C, $I_S = -10$ A, $V_{GS} = 0$
t_r Reverse Recovery Time		530		ns	$T_J = 150$ C, $I_F = I_S$, $d_F/ds = 100$ A/ms

¹ Pulse Test: Pulse Width 300msec, Duty Cycle 2%.

ELECTRICAL CHARACTERISTICS: $T_C = 25^\circ$ unless otherwise noted
 STATIC P/N COM440T

Parameter	Min.	Typ.	Max.	Units	Test Conditions
BV_{DSS} Drain-Source Breakdown Voltage	500			V	$V_{GS} = 0$, $I_D = 250$ mA
$V_{GS(th)}$ Gate-Threshold Voltage	2.0		4.0	V	$V_{DS} = V_{GS}$, $I_D = 250$ mA
I_{SSF} Gate-Body Leakage Forward			100	nA	$V_{GS} = 20$ V
I_{SSR} Gate-Body Leakage Reverse			-100	nA	$V_{GS} = -20$ V
I_{SS} Zero Gate Voltage Drain Current		0.1 0.2	0.25 1.0	m A	$V_{DS} = \text{Max. Rat.}$, $V_{GS} = 0$ $V_{DS} = 0.8 \text{ Max. Rat.}$, $V_{GS} = 0$, $T_C = 125^\circ$ C
$I_{D(on)}$ On-State Drain Current ¹	4.5			A	$V_{DS} = 2 V_{DS(on)}$, $V_{GS} = 10$ V
$V_{DS(on)}$ Static Drain-Source On-State Voltage ¹		3.2	3.52	V	$V_{GS} = 10$ V, $I_D = 4$ A
$R_{DS(on)}$ Static Drain-Source On-State Resistance ¹			0.90		$V_{GS} = 10$ V, $I_D = 4$ A
$R_{DS(on)}$ Static Drain-Source On-State Resistance ¹			1.8		$V_{GS} = 10$ V, $I_D = 4$ A, $T_C = 125$ C

DYNAMIC

g_b Forward Transconductance ¹	4.0	4.8		S(M)	$V_{DS} = 2 V_{DS(on)}$, $I_D = 4$ A
C_{iss} Input Capacitance		1225		pF	$V_{GS} = 0$
C_{oss} Output Capacitance		200		pF	$V_{DS} = 25$ V
C_{rss} Reverse Transfer Capacitance		85		pF	$f = 1$ MHz
$T_{d(on)}$ Turn-On Delay Time		17		ns	$V_{DD} = 200$ V, $I_D = 4$ A
t_r Rise Time		5		ns	$R_g = 5$ W, $V_{DS} = 10$ V
$T_{d(off)}$ Turn-Off Delay Time		42		ns	(MOSFET) switching times are essentially independent of operating temperature.
t_f Fall Time		14		ns	

BODY-DRAIN DIODE RATINGS AND CHARACTERISTICS

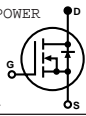
I_S Continuous Source Current (Body Diode)			-8	A	Modified MOSPOWER symbol showing the integral P-N Junction rectifier. 
I_{SM} Source Current ¹ (Body Diode)			-32	A	
V_{SD} Diode Forward Voltage ¹			-2	V	$T_C = 25$ C, $I_S = -18$ A, $V_{GS} = 0$
t_r Reverse Recovery Time		700		ns	$T_J = 150$ C, $I_F = I_S$, $d_F/ds = 100$ A/ms

¹ Pulse Test: Pulse Width 300msec, Duty Cycle 2%.

COM140T - COM440T

ABSOLUTE MAXIMUM RATINGS ($T_C = 25^\circ\text{C}$ unless otherwise noted)

Parameter	COM140T	COM240T	COM340T	COM440T	Units
V_{DS} Drain-Source Voltage	100	200	400	500	V
V_{DGR} Drain-Gate Voltage ($R_{GS} = 1\text{ M}$)	100	200	400	500	V
$I_D @ T_C = 25^\circ\text{C}$ Continuous Drain Current ²	± 14	± 14	± 10	± 8	A
$I_D @ T_C = 100^\circ\text{C}$ Continuous Drain Current ²	± 14	± 11	± 6	± 5	A
I_{DM} Pulsed Drain Current ¹	± 56	± 56	± 40	± 32	A
V_{GS} Gate-Source Voltage	± 20	± 20	± 20	± 20	V
$P_D @ T_C = 25^\circ\text{C}$ Maximum Power Dissipation	125	125	125	125	W
$P_D @ T_C = 100^\circ\text{C}$ Maximum Power Dissipation	50	50	50	50	W
Junction To Case Linear Derating Factor	1.0	1.0	1.0	1.0	W/ $^\circ\text{C}$
Junction To Ambient Linear Derating Factor	.015	.015	.015	.015	W/ $^\circ\text{C}$
T_J Operating and T_{stg} Storage Temperature Range	-55 to 150	-55 to 150	-55 to 150	-55 to 150	$^\circ\text{C}$
Lead Temperature (1/16" from case for 10 secs.)	300	300	300	300	$^\circ\text{C}$

- 1 Pulse Test: Pulse width 300 μsec . Duty Cycle 2%.
- 2 Package pin limitation = 10 Amps

THERMAL RESISTANCE

R_{thJC} Junction-to-Case	1.00	$^\circ\text{C}/\text{W}$	
R_{thJA} Junction-to-Ambient	65	$^\circ\text{C}/\text{W}$	Free Air Operation

POWER DERATING

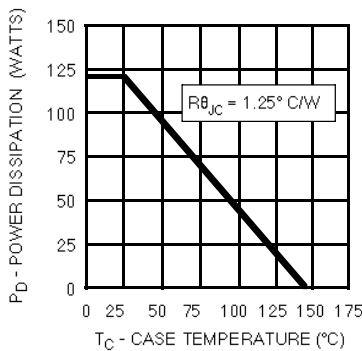

MECHANICAL OUTLINE

TO-257

