

**HEXFET® POWER MOSFET
 SURFACE MOUNT (SMD-0.5)**

**IRL7NJ3802
 12V, N-CHANNEL**

Product Summary

Part Number	BV _{DSS}	R _{DS(on)}	I _D
IRL7NJ3802	12V	0.0085	22A*



Seventh Generation HEXFET® power MOSFETs from International Rectifier utilize advanced processing techniques to achieve the lowest possible on-resistance per silicon unit area. This benefit, combined with the fast switching speed and ruggedized device design that HEXFET power MOSFETs are well known for, provides the designer with an extremely efficient device for use in a wide variety of applications.

These devices are well-suited for applications such as switching power supplies, motor controls, inverters, choppers, audio amplifiers and high-energy pulse circuits.

Features:

- Low R_{DS(on)}
- Avalanche Energy Ratings
- Simple Drive Requirements
- Ease of Paralleling
- Hermetically Sealed
- Surface Mount
- Light Weight

Absolute Maximum Ratings

	Parameter		Units
I _D @ V _{GS} = 4.5V, T _C = 25°C	Continuous Drain Current	22*	A
I _D @ V _{GS} = 4.5V, T _C = 100°C	Continuous Drain Current	22*	
I _{DM}	Pulsed Drain Current ①	88	
P _D @ T _C = 25°C	Max. Power Dissipation	50	W
	Linear Derating Factor	0.4	W/°C
V _{GS}	Gate-to-Source Voltage	±12	V
EAS	Single Pulse Avalanche Energy ②	130	mJ
I _{AR}	Avalanche Current ①	22	A
EAR	Repetitive Avalanche Energy ①	5.0	mJ
T _J	Operating Junction	-55 to 150	°C
T _{STG}	Storage Temperature Range		
	Package Mounting Surface Temperature	300 (for 5 s)	
	Weight	1.0	g

* Current is limited by package

For footnotes refer to the last page

Electrical Characteristics @ T_j = 25°C (Unless Otherwise Specified)

	Parameter	Min	Typ	Max	Units	Test Conditions
B _V DSS	Drain-to-Source Breakdown Voltage	12	—	—	V	V _{GS} = 0V, I _D = 250μA
ΔB _V DSS/ΔT _J	Temperature Coefficient of Breakdown Voltage	—	0.009	—	V/°C	Reference to 25°C, I _D = 1.0mA
R _{DS(on)}	Static Drain-to-Source On-State Resistance	—	—	0.0085	Ω	V _{GS} = 4.5V, I _D = 22A ③
		—	—	0.03		V _{GS} = 2.8V, I _D = 22A
V _{GS(th)}	Gate Threshold Voltage	0.6	—	1.9	V	V _{DS} = V _{GS} , I _D = 250μA
g _{fs}	Forward Transconductance	42	—	—	S (r)	V _{DS} = 6.0V, I _{DS} = 22A ③
I _{DSS}	Zero Gate Voltage Drain Current	—	—	100	μA	V _{DS} = 9.6V, V _{GS} = 0V
		—	—	250		V _{DS} = 9.6V, V _{GS} = 0V, T _J = 125°C
I _{GSS}	Gate-to-Source Leakage Forward	—	—	100	nA	V _{GS} = 12V
I _{GSS}	Gate-to-Source Leakage Reverse	—	—	-100		V _{GS} = -12V
Q _g	Total Gate Charge	—	—	41	nC	V _{GS} = 4.5V, I _D = 22A
Q _{gs}	Gate-to-Source Charge	—	—	12		V _{DS} = 6.0V
Q _{gd}	Gate-to-Drain ('Miller') Charge	—	—	10.5		
t _{d(on)}	Turn-On Delay Time	—	—	15	ns	V _{DD} = 6.0V, I _D = 22A, V _{GS} = 4.5V, R _G = 6.0Ω
t _r	Rise Time	—	—	115		
t _{d(off)}	Turn-Off Delay Time	—	—	30		
t _f	Fall Time	—	—	25		
L _S + L _D	Total Inductance	—	4.0	—	nH	Measured from the center of drain pad to center of source pad
C _{iss}	Input Capacitance	—	2470	—	pF	V _{GS} = 0V, V _{DS} = 6.0V f = 1.0MHz
C _{oss}	Output Capacitance	—	2130	—		
C _{rss}	Reverse Transfer Capacitance	—	500	—		
R _g	Gate Resistance	—	1.9	—		

Source-Drain Diode Ratings and Characteristics

	Parameter	Min	Typ	Max	Units	Test Conditions
I _S	Continuous Source Current (Body Diode)	—	—	22*	A	
I _{SM}	Pulse Source Current (Body Diode) ①	—	—	88		
V _{SD}	Diode Forward Voltage	—	—	1.2	V	T _j = 25°C, I _S = 22A, V _{GS} = 0V ③
t _{rr}	Reverse Recovery Time	—	—	40	nS	T _j = 25°C, I _F = 22A, di/dt ≤ 100A/μs
Q _R R	Reverse Recovery Charge	—	—	40	nC	V _{DD} ≤ 6.0V ③
t _{on}	Forward Turn-On Time	Intrinsic turn-on time is negligible. Turn-on speed is substantially controlled by L _S + L _D .				

* Current is limited by package

Thermal Resistance

	Parameter	Min	Typ	Max	Units	Test Conditions
R _{thJC}	Junction-to-Case	—	—	2.5	°C/W	

Note: Corresponding Spice and Saber models are available on International Rectifier Website.

For footnotes refer to the last page

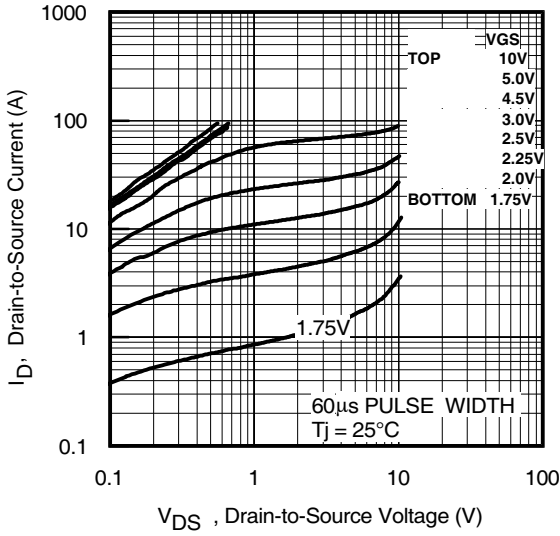

Fig 1. Typical Output Characteristics

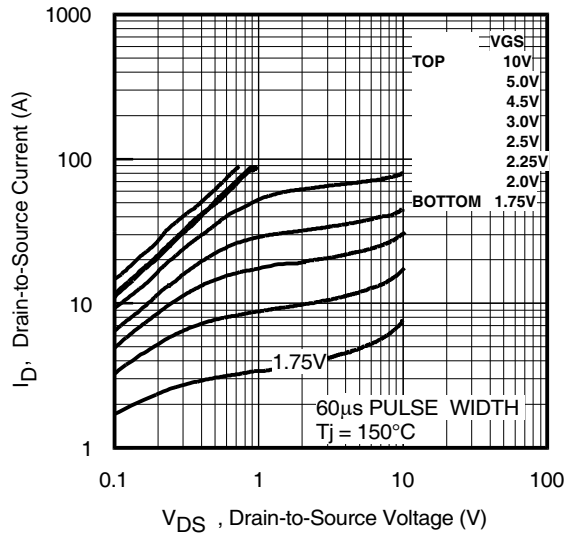

Fig 2. Typical Output Characteristics

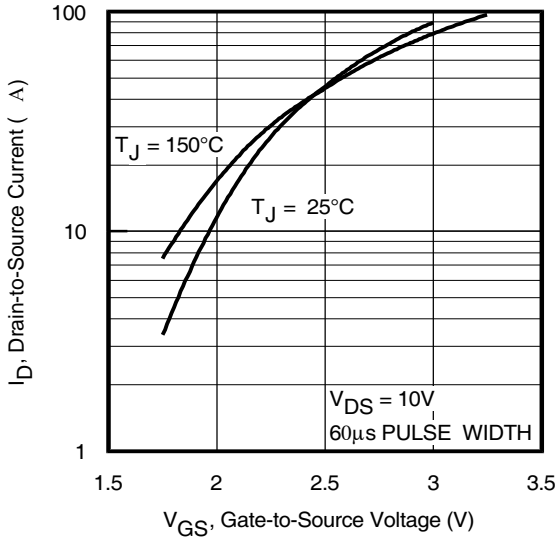

Fig 3. Typical Transfer Characteristics

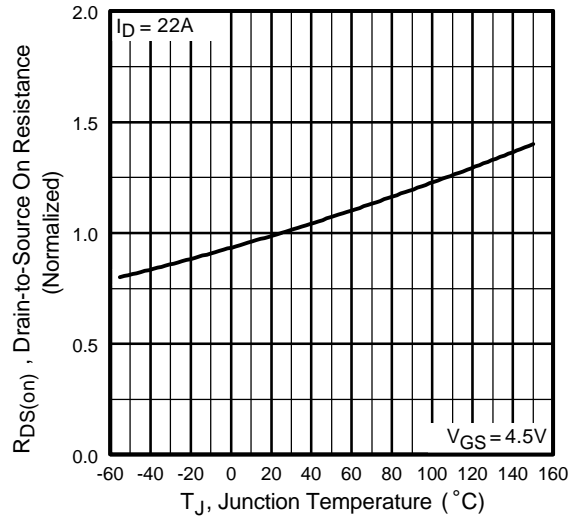

Fig 4. Normalized On-Resistance Vs. Temperature

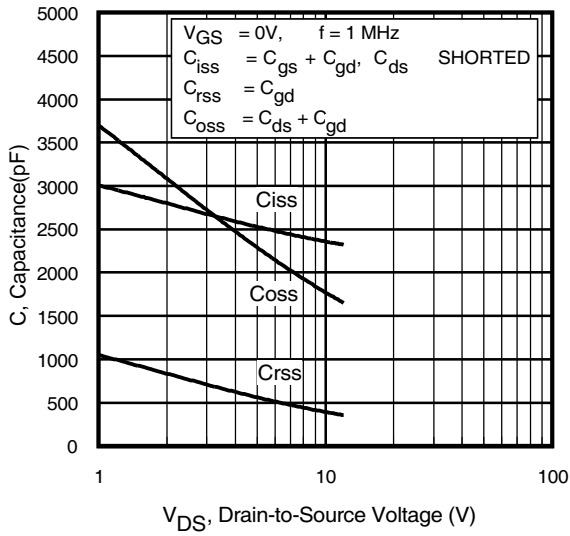

Fig 5. Typical Capacitance Vs. Drain-to-Source Voltage

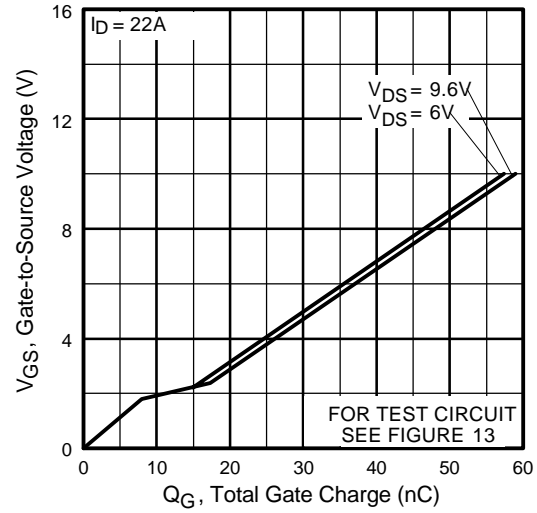

Fig 6. Typical Gate Charge Vs. Gate-to-Source Voltage

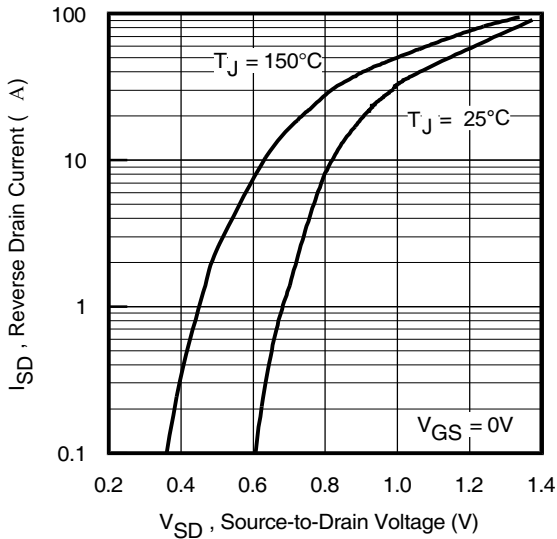

Fig 7. Typical Source-Drain Diode Forward Voltage

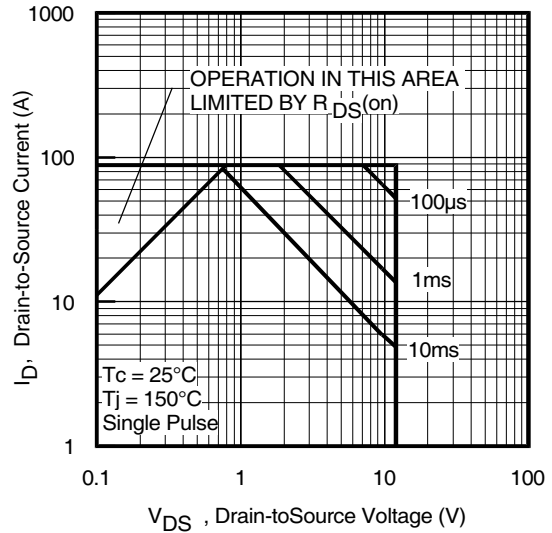

Fig 8. Maximum Safe Operating Area

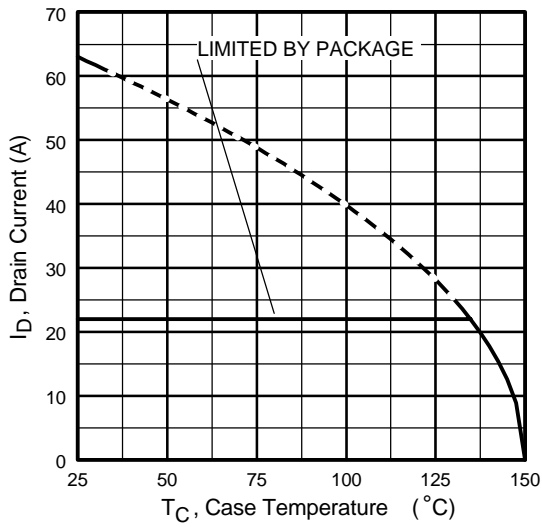

Fig 9. Maximum Drain Current Vs. Case Temperature

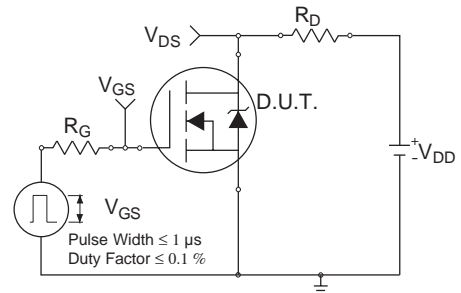

Fig 10a. Switching Time Test Circuit

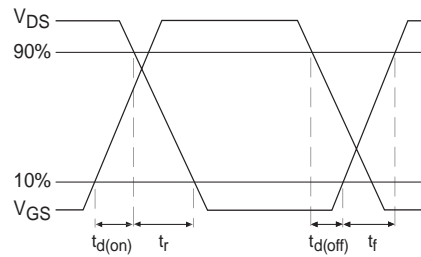

Fig 10b. Switching Time Waveforms

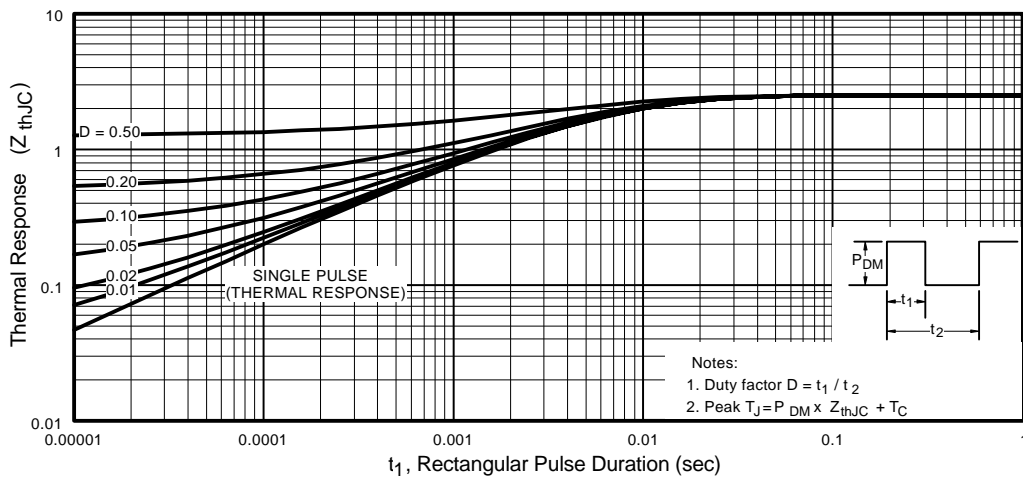

Fig 11. Maximum Effective Transient Thermal Impedance, Junction-to-Case

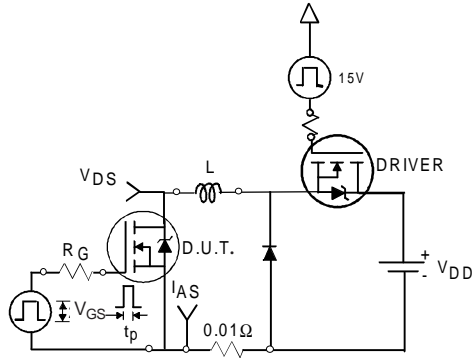

Fig 12a. Unclamped Inductive Test Circuit

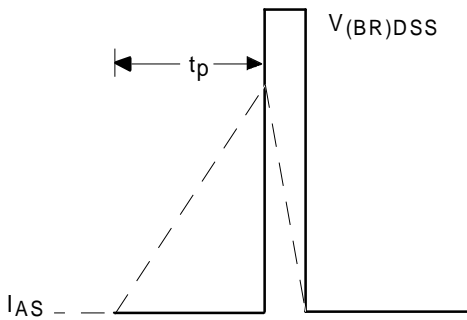

Fig 12b. Unclamped Inductive Waveforms

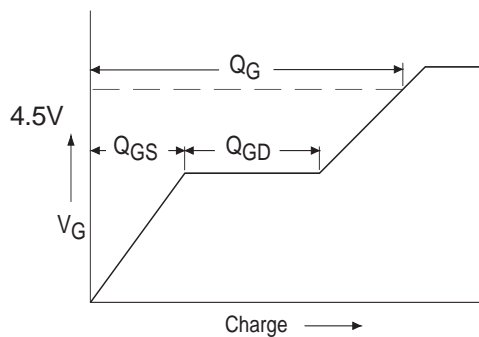

Fig 13a. Basic Gate Charge Waveform

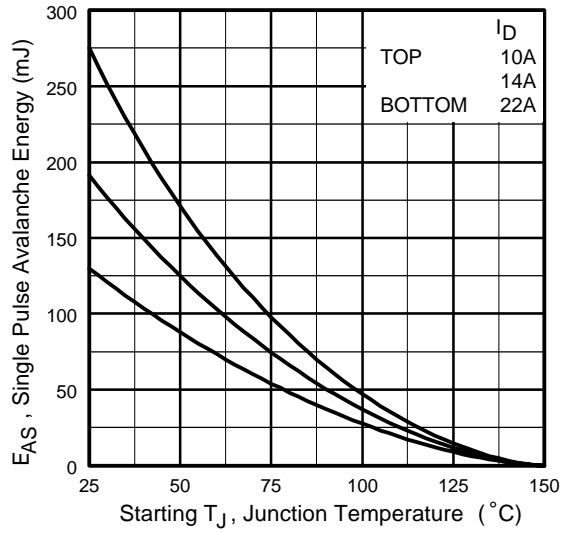

Fig 12c. Maximum Avalanche Energy Vs. Drain Current

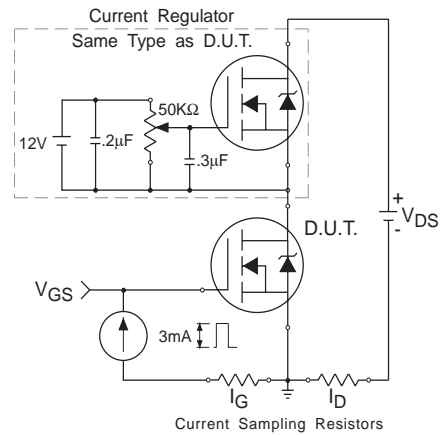
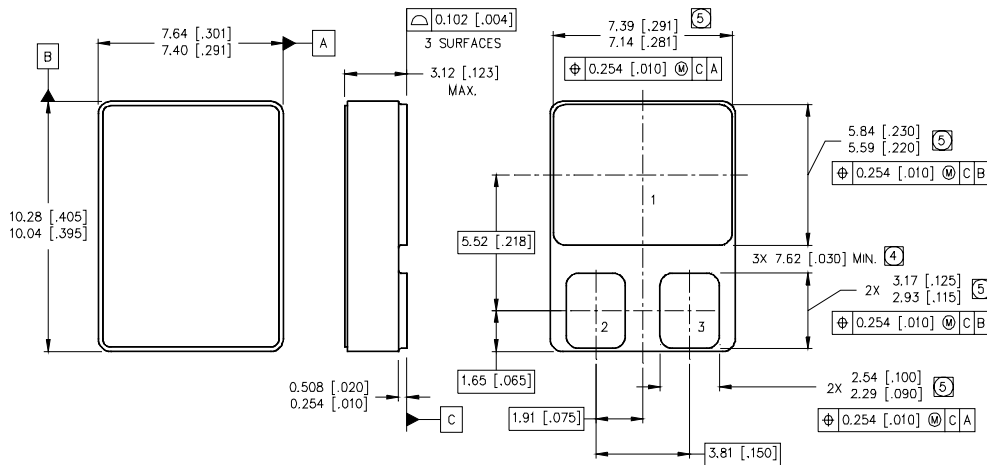

Fig 13b. Gate Charge Test Circuit

Footnotes:

- ① Repetitive Rating; Pulse width limited by maximum junction temperature.
- ② $V_{DD} = 25\text{ V}$, Starting $T_J = 25^\circ\text{C}$, $L=0.5\text{mH}$
 Peak $I_{AS} = 22\text{A}$, $R_G = 25\Omega$
- ③ Pulse width $\leq 300\ \mu\text{s}$; Duty Cycle $\leq 2\%$

Case Outline and Dimensions — SMD-0.5



NOTES:

1. DIMENSIONING & TOLERANCING PER ASME Y14.5M-1994.
2. CONTROLLING DIMENSION: INCH.
3. DIMENSIONS ARE SHOWN IN MILLIMETERS [INCHES].
- ④ DIMENSION INCLUDES METALLIZATION FLASH.
- ⑤ DIMENSION DOES NOT INCLUDE METALLIZATION FLASH.

PAD ASSIGNMENTS

- 1 = DRAIN
- 2 = GATE
- 3 = SOURCE