

Description/ Features

The IRKCS203.. Schottky rectifier Common Cathode has been optimized for low reverse leakage at high temperature. The proprietary barrier technology allows for reliable operation up to 150°C junction temperature. Typical applications are in high current switching power supplies, plating power supplies, UPS systems, converters, free-wheeling diodes, welding, and reverse battery protection.

- 150°C T_J operation
- Low forward voltage drop
- High frequency operation
- Guard ring for enhanced ruggedness and long term reliability
- UL pending
- TOTALLY LEAD-FREE, RoHS Compliant

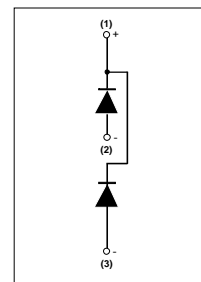

Mechanical Description

The Generation V of Add-A-pak module combine the excellent thermal performance obtained by the usage of Direct Bonded Copper substrate with superior mechanical ruggedness, thanks to the insertion of a solid Copper baseplate at the bottom side of the device. The Cu baseplate allow an easier mounting on the majority of heatsink with increased tolerance of surface roughness and improve thermal spread.

The Generation V of AAP module is manufactured without hard mold, eliminating in this way any possible direct stress on the leads.

The electrical terminals are secured against axial pull-out: they are fixed to the module housing via a click-stop feature already tested and proved as reliable on other IR modules.

Major Ratings and Characteristics

Characteristics	Values	Units
$I_{F(AV)}$ Rectangular waveform	200	A
V_{RRM}	100	V
I_{FSM} @tp = 5 μ s sine	12800	A
V_F @100Apk, $T_J=125^\circ\text{C}$	0.76	V
T_J range	-55 to 175	$^\circ\text{C}$



Voltage Ratings

Parameters	IRKCS203/100P
V_R Max. DC Reverse Voltage (V)	100
V_{RWM} Max. Working Peak Reverse Voltage (V)	

Absolute Maximum Ratings

Parameters	Values	Units	Conditions
$I_{F(AV)}$ Max. Average Forward Current	Per Module	200	50% duty cycle @ $T_C = 119^\circ\text{C}$, rectangular wave form
	Per Leg	100	
I_{FSM} Max. Peak One Cycle Non-Repetitive Surge Current	12800	A	5 μs Sine or 3 μs Rect. pulse
	1700		10ms Sine or 6ms Rect. pulse
E_{AS} Non-Repetitive Avalanche Energy	15	mJ	$T_J = 25^\circ\text{C}$, $I_{AS} = 5.5\text{Amps}$, $L = 1\text{mH}$
I_{AR} Repetitive Avalanche Current	1	A	Current decaying linearly to zero in 1 μsec Frequency limited by T_J max. $V_A = 1.5 \times V_R$ typical

Electrical Specifications

Parameters	Values	Units	Conditions
V_{FM} Max. Forward Voltage Drop (1)	0.9	V	@ 100A
	1.19	V	@ 200A
	0.76	V	@ 100A
	0.98	V	@ 200A
I_{RM} Max. Reverse Leakage Current (1)	3	mA	$T_J = 25^\circ\text{C}$
	40	mA	$T_J = 125^\circ\text{C}$
C_T Max. Junction Capacitance	2750	pF	$V_R = 5V_{DC}$ (test signal range 100Khz to 1Mhz) 25°C
L_S Typical Series Inductance	7.0	nH	From top of terminal hole to mounting plane
dv/dt Max. Voltage Rate of Change	10000	V/ μs	(Rated V_R)
V_{INS} RMS isolation voltage (1 sec)	3500	V	50 Hz, circuit to base, all terminals shorted

(1) Pulse Width < 500 μs

Thermal-Mechanical Specifications

Parameters	Values	Units	Conditions
T_J Max. Junction Temperature Range	-55 to 175	$^\circ\text{C}$	
T_{stg} Max. Storage Temperature Range	-55 to 175	$^\circ\text{C}$	
R_{thJC} Max. Thermal Resistance, Junction to Case (Per Leg)	0.6	$^\circ\text{C/W}$	DC operation
R_{thCS} Max. Thermal Resistance, case to Heatsink	0.1	$^\circ\text{C/W}$	Mounting Surface, smooth and greased
wt Approximate Weight	110 (4)	gr (oz)	
T Mounting Torque $\pm 10\%$	to heatsink	5	Nm
	busbar	4	
Case Style	TO-240AA		JEDEC

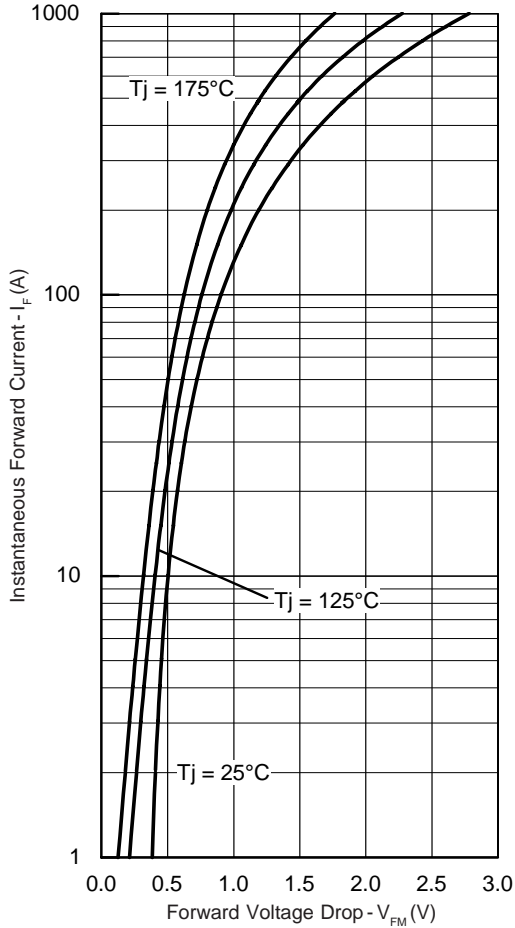

Fig. 1 - Max. Forward Voltage Drop Characteristics

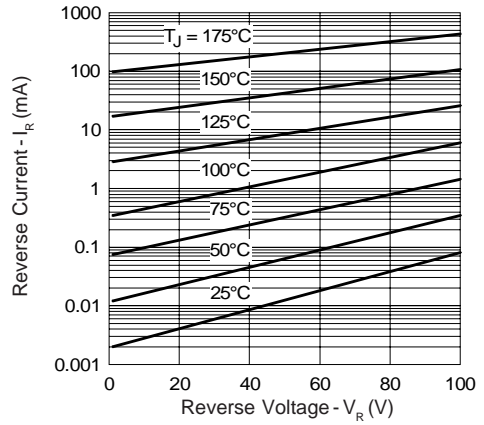

Fig. 2 - Typical Values Of Reverse Current Vs. Reverse Voltage

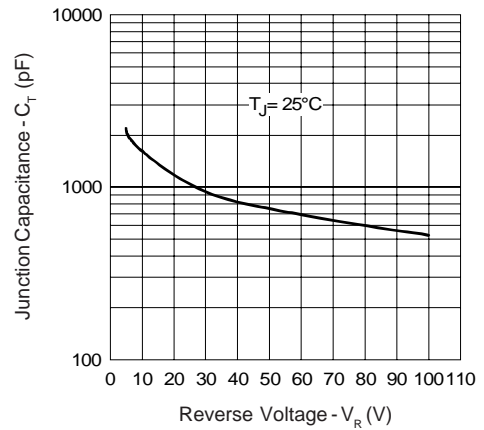

Fig. 3 - Typical Junction Capacitance Vs. Reverse Voltage

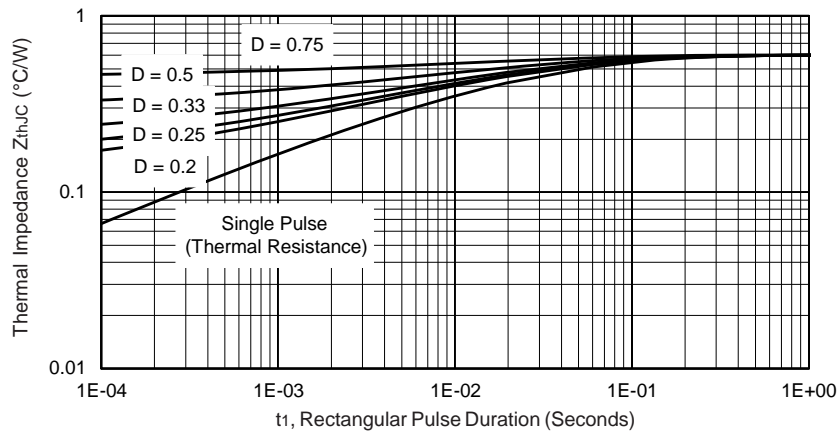

Fig. 4 - Max. Thermal Impedance Z_{thJC} Characteristics

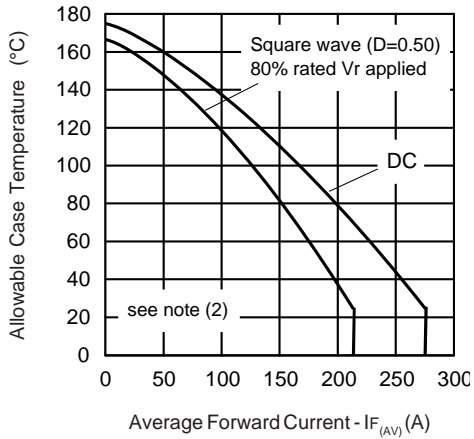

Fig.5 - Max. Allowable Case Temperature Vs. Average Forward Current

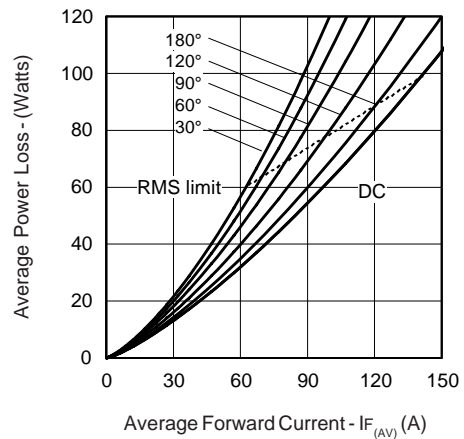

Fig.6 - Forward Power Loss Characteristics

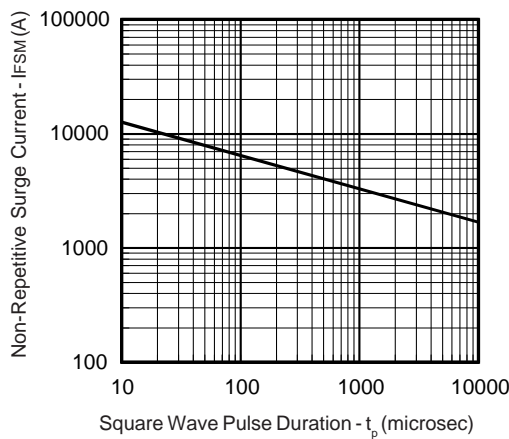

Fig.7 - Max. Non-Repetitive Surge Current

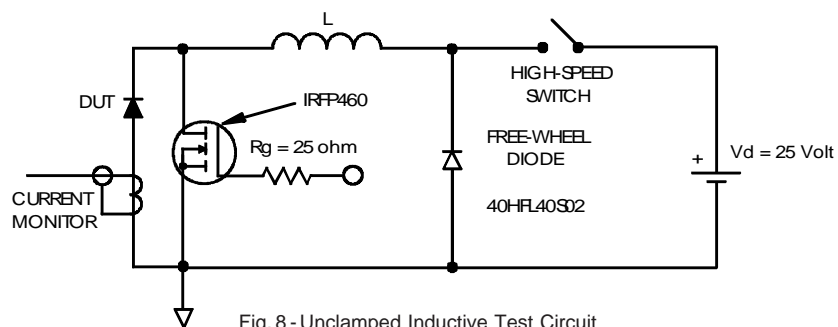
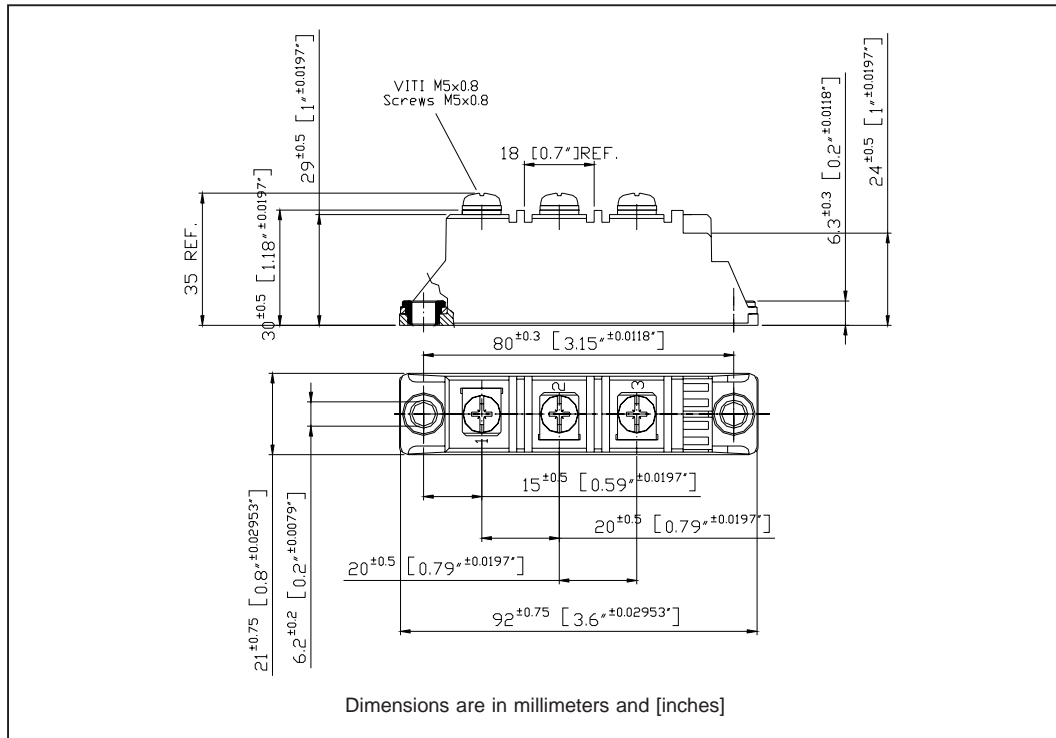

Fig.8 - Unclamped Inductive Test Circuit

- (2) Formula used: $T_c = T_j - (Pd + Pd_{REV}) \times R_{thJC}$;
 $Pd = \text{Forward Power Loss} = I_{F(AV)} \times V_{FM} @ (I_{F(AV)} / D)$ (see Fig. 6);
 $Pd_{REV} = \text{Inverse Power Loss} = V_{R1} \times I_R (1 - D)$; $I_R @ V_{R1} = 80\% \text{ rated } V_R$

Outline Table



Ordering Information Table

Device Code						
IR	KC	S	20	3	/	100 P
①	②	③	④	⑤	⑥	⑦
1	-	International Rectifier				
2	-	Circuit Configuration				
		KC = Add-A-Pak - 2 diodes/common cathode				
3	-	S = Schottky Diode				
4	-	Average Rating (x10)				
5	-	Product Silicon Identification				
6	-	Voltage Rating (100 = 100V)				
7	-	Lead-Free				

IRKCS203/100P

Bulletin I27268 rev. A 12/06

International
IOR Rectifier

Data and specifications subject to change without notice.
This product has been designed and qualified for Industrial Level and Lead-Free.
Qualification Standards can be found on IR's Web site.

International
IOR Rectifier

IR WORLD HEADQUARTERS: 233 Kansas St., El Segundo, California 90245, USA Tel: (310) 252-7105
TAC Fax: (310) 252-7309
Visit us at www.irf.com for sales contact information. 12/06