

#### Description/ Features

The IRKCS201.. Schottky rectifier Common Cathode has been optimized for low reverse leakage at high temperature. The proprietary barrier technology allows for reliable operation up to 175°C junction temperature. Typical applications are in high current switching power supplies, plating power supplies, UPS systems, converters, free-wheeling diodes, welding, and reverse battery protection.

- 175°C  $T_J$  operation
- Low forward voltage drop
- High frequency operation
- Guard ring for enhanced ruggedness and long term reliability
- UL pending
- TOTALLY LEAD-FREE, RoHS Compliant

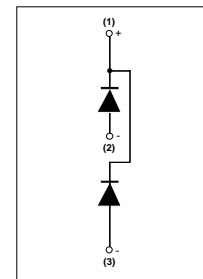

#### Mechanical Description

The Generation V of Add-A-pak module combine the excellent thermal performance obtained by the usage of Direct Bonded Copper substrate with superior mechanical ruggedness, thanks to the insertion of a solid Copper baseplate at the bottom side of the device. The Cu baseplate allow an easier mounting on the majority of heatsink with increased tolerance of surface roughness and improve thermal spread.

The Generation V of AAP module is manufactured without hard mold, eliminating in this way any possible direct stress on the leads.

The electrical terminals are secured against axial pull-out: they are fixed to the module housing via a click-stop feature already tested and proved as reliable on other IR modules.

#### Major Ratings and Characteristics

Characteristics	Values	Units
$I_{F(AV)}$ Rectangular waveform	200	A
$V_{RRM}$	45	V
$I_{FSM}$ @tp = 5 $\mu$ s sine	8600	A
$V_F$ @100Apk, $T_J=125^\circ\text{C}$	0.65	V
$T_J$ range	-55 to 175	$^\circ\text{C}$



## Voltage Ratings

Parameters	IRKCS201/045P
$V_R$ Max. DC Reverse Voltage (V)	45
$V_{RWM}$ Max. Working Peak Reverse Voltage (V)	

## Absolute Maximum Ratings

Parameters	Values	Units	Conditions
$I_{F(AV)}$ Max. Average Forward Current	Per Module	200	50% duty cycle @ $T_C = 120^\circ\text{C}$ , rectangular wave form
	Per Leg	100	
$I_{FSM}$ Max. Peak One Cycle Non-Repetitive Surge Current	8600	A	5 $\mu\text{s}$ Sine or 3 $\mu\text{s}$ Rect. pulse
	1850		10ms Sine or 6ms Rect. pulse
$E_{AS}$ Non-Repetitive Avalanche Energy	270	mJ	$T_J = 25^\circ\text{C}$ , $I_{AS} = 24$ Amps, $L = 1\text{mH}$
$I_{AR}$ Repetitive Avalanche Current (Per Leg)	20	A	Current decaying linearly to zero in 1 $\mu\text{sec}$ Frequency limited by $T_J$ max. $V_A = 1.5 \times V_R$ typical

## Electrical Specifications

Parameters	Values	Units	Conditions
$V_{FM}$ Max. Forward Voltage Drop (1)	0.7	V	@ 100A
	0.92	V	@ 200A
	0.65	V	@ 100A
	0.86	V	@ 200A
$I_{RM}$ Max. Reverse Leakage Current (1)	10	mA	$T_J = 25^\circ\text{C}$
	90	mA	$T_J = 125^\circ\text{C}$
$C_T$ Max. Junction Capacitance	5200	pF	$V_R = 5V_{DC}$ (test signal range 100Khz to 1Mhz) $25^\circ\text{C}$
$L_S$ Typical Series Inductance	7.0	nH	From top of terminal hole to mounting plane
dv/dt Max. Voltage Rate of Change	10000	V/ $\mu\text{s}$	(Rated $V_R$ )
$V_{INS}$ RMS isolation voltage (1 sec)	3500	V	50 Hz, circuit to base, all terminals shorted

(1) Pulse Width < 500 $\mu\text{s}$ 

## Thermal-Mechanical Specifications

Parameters	Values	Units	Conditions
$T_J$ Max. Junction Temperature Range	-55 to 175	$^\circ\text{C}$	
$T_{stg}$ Max. Storage Temperature Range	-55 to 175	$^\circ\text{C}$	
$R_{thJC}$ Max. Thermal Resistance, Junction to Case (Per Leg)	0.6	$^\circ\text{C/W}$	DC operation
$R_{thCS}$ Max. Thermal Resistance, case to Heatsink	0.1	$^\circ\text{C/W}$	Mounting Surface, smooth and greased
wt Approximate Weight	110 (4)	gr (oz)	
T Mounting Torque $\pm 10\%$	to heatsink	5	Nm
	busbar	4	
Case Style	TO - 240AA		JEDEC

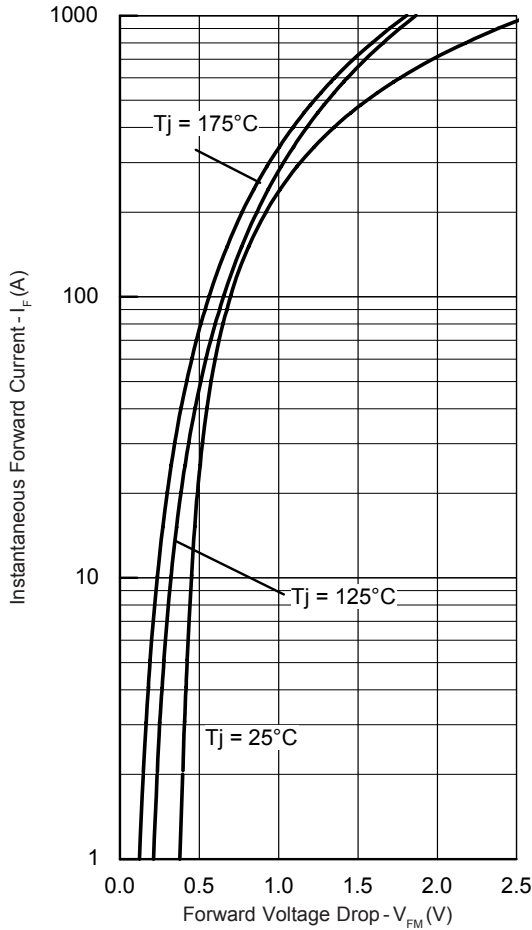

Fig. 1 - Max. Forward Voltage Drop Characteristics

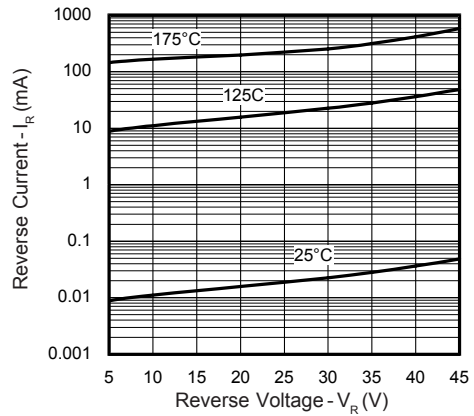

Fig. 2 - Typical Values Of Reverse Current Vs. Reverse Voltage

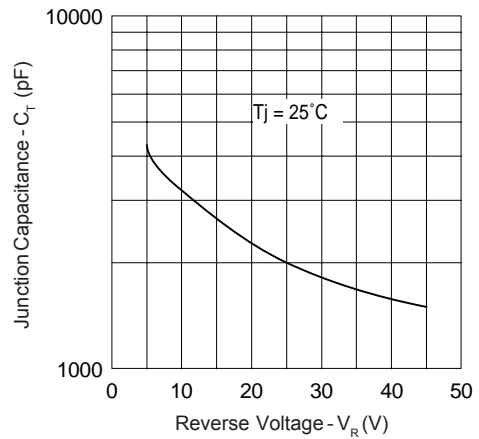

Fig. 3 - Typical Junction Capacitance Vs. Reverse Voltage

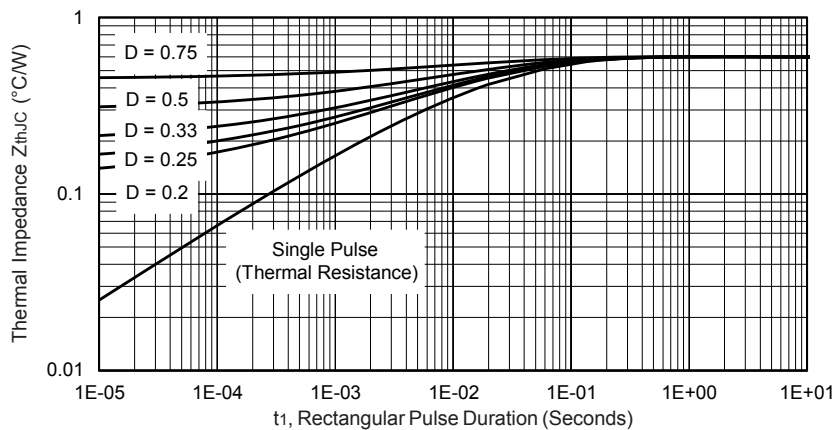

Fig. 4 - Max. Thermal Impedance  $Z_{thJC}$  Characteristics

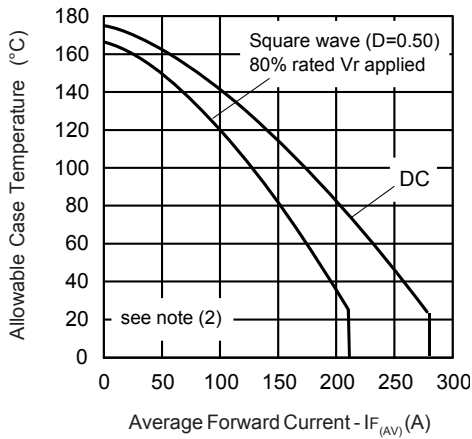

Fig.5 - Max. Allowable Case Temperature Vs. Average Forward Current

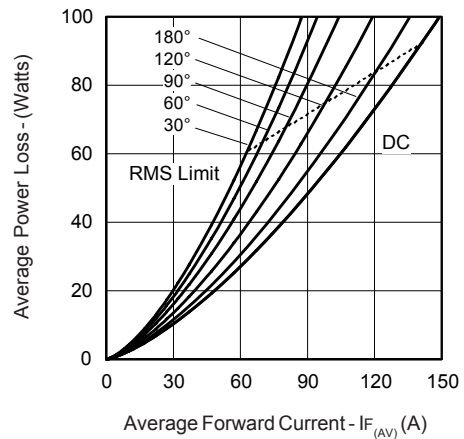

Fig.6 - Forward Power Loss Characteristics

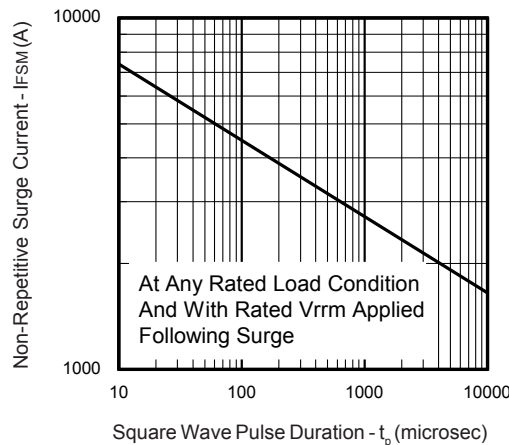

Fig.7 - Max. Non-Repetitive Surge Current

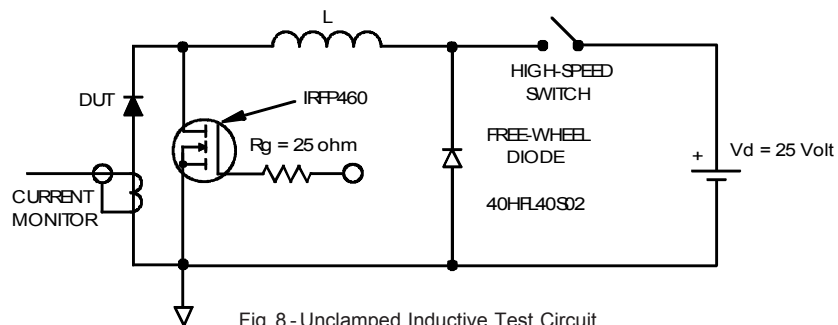

Fig.8 - Unclamped Inductive Test Circuit

(2) Formula used:  $T_C = T_J - (Pd + Pd_{REV}) \times R_{thJC}$ ;

$Pd$  = Forward Power Loss =  $I_{F(AV)} \times V_{FM} @ (I_{F(AV)} / D)$  (see Fig. 6);

$Pd_{REV}$  = Inverse Power Loss =  $V_{R1} \times I_R (1 - D)$ ;  $I_R @ V_{R1} = 80\%$  rated  $V_R$



Data and specifications subject to change without notice.  
This product has been designed and qualified for Industrial Level and Lead-Free.  
Qualification Standards can be found on IR's Web site.

International  
**IOR** Rectifier

**IR WORLD HEADQUARTERS:** 233 Kansas St., El Segundo, California 90245, USA Tel: (310) 252-7105  
TAC Fax: (310) 252-7309  
Visit us at [www.irf.com](http://www.irf.com) for sales contact information. 12/06