

**RADIATION HARDENED  
POWER MOSFET  
SURFACE MOUNT (SMD-0.5)**

**IRHNJ57130  
JANSR2N7481U3  
100V, N-CHANNEL  
REF: MIL-PRF-19500/703**



**Product Summary**

Part Number	Radiation Level	RDS(on)	Id	QPL Part Number
IRHNJ57130	100K Rads (Si)	0.06Ω	22A*	JANSR2N7481U3
IRHNJ53130	300K Rads (Si)	0.06Ω	22A*	JANSF2N7481U3
IRHNJ54130	500K Rads (Si)	0.06Ω	22A*	JANSG2N7481U3
IRHNJ58130	1000K Rads(Si)	0.075Ω	22A*	JANSH2N7481U3

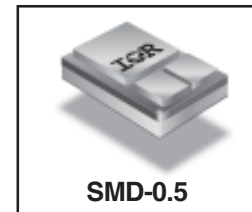

International Rectifier's R5™ technology provides high performance power MOSFETs for space applications. These devices have been characterized for Single Event Effects (SEE) with useful performance up to an LET of 80 (MeV/(mg/cm<sup>2</sup>)). The combination of low RDS(on) and low gate charge reduces the power losses in switching applications such as DC to DC converters and motor control. These devices retain all of the well established advantages of MOSFETs such as voltage control, fast switching, ease of paralleling and temperature stability of electrical parameters.

**Features:**

- Single Event Effect (SEE) Hardened
- Ultra Low RDS(on)
- Low Total Gate Charge
- Simple Drive Requirements
- Ease of Paralleling
- Hermetically Sealed
- Surface Mount
- Ceramic Package
- Light Weight

**Absolute Maximum Ratings**

**Pre-Irradiation**

	Parameter		Units
Id @ VGS = 12V, TC = 25°C	Continuous Drain Current	22*	A
Id @ VGS = 12V, TC = 100°C	Continuous Drain Current	16	
IDM	Pulsed Drain Current ①	88	
PD @ TC = 25°C	Max. Power Dissipation	75	W
	Linear Derating Factor	0.6	W/°C
VGS	Gate-to-Source Voltage	±20	V
EAS	Single Pulse Avalanche Energy ②	70	mJ
IAR	Avalanche Current ①	22	A
EAR	Repetitive Avalanche Energy ①	7.5	mJ
dv/dt	Peak Diode Recovery dv/dt ③	1.4	V/ns
TJ	Operating Junction	-55 to 150	°C
TSTG	Storage Temperature Range		
	Pckg. Mounting Surface Temp.	300 (for 5s)	
	Weight	1.0 (Typical)	g

\* Current is limited by package

For footnotes refer to the last page

www.irf.com

**Electrical Characteristics @ T<sub>j</sub> = 25°C (Unless Otherwise Specified)**

	Parameter	Min	Typ	Max	Units	Test Conditions
BV <sub>DSS</sub>	Drain-to-Source Breakdown Voltage	100	—	—	V	V <sub>GS</sub> = 0V, I <sub>D</sub> = 1.0mA
ΔBV <sub>DSS</sub> /ΔT <sub>J</sub>	Temperature Coefficient of Breakdown Voltage	—	0.11	—	V/°C	Reference to 25°C, I <sub>D</sub> = 1.0mA
R <sub>DS(on)</sub>	Static Drain-to-Source On-State Resistance	—	—	0.06	Ω	V <sub>GS</sub> = 12V, I <sub>D</sub> = 16A ④
V <sub>GS(th)</sub>	Gate Threshold Voltage	2.0	—	4.0	V	V <sub>DS</sub> = V <sub>GS</sub> , I <sub>D</sub> = 1.0mA
g <sub>fs</sub>	Forward Transconductance	13	—	—	S	V <sub>DS</sub> ≥ 15V, I <sub>DS</sub> = 16A ④
I <sub>DSS</sub>	Zero Gate Voltage Drain Current	—	—	10	μA	V <sub>DS</sub> = 80V, V <sub>GS</sub> = 0V
		—	—	25		V <sub>DS</sub> = 80V, V <sub>GS</sub> = 0V, T <sub>J</sub> = 125°C
I <sub>GSS</sub>	Gate-to-Source Leakage Forward	—	—	100	nA	V <sub>GS</sub> = 20V
I <sub>GSS</sub>	Gate-to-Source Leakage Reverse	—	—	-100		V <sub>GS</sub> = -20V
Q <sub>g</sub>	Total Gate Charge	—	—	50	nC	V <sub>GS</sub> = 12V, I <sub>D</sub> = 22A V <sub>DS</sub> = 50V
Q <sub>gs</sub>	Gate-to-Source Charge	—	—	7.4		
Q <sub>gd</sub>	Gate-to-Drain ('Miller') Charge	—	—	20		
t <sub>d(on)</sub>	Turn-On Delay Time	—	—	25	ns	V <sub>DD</sub> = 50V, I <sub>D</sub> = 22A, V <sub>GS</sub> = 12V, R <sub>G</sub> = 7.5Ω
t <sub>r</sub>	Rise Time	—	—	100		
t <sub>d(off)</sub>	Turn-Off Delay Time	—	—	35		
t <sub>f</sub>	Fall Time	—	—	30		
L <sub>S</sub> + L <sub>D</sub>	Total Inductance	—	4.0	—	nH	Measured from the center of drain pad to center of source pad
C <sub>iss</sub>	Input Capacitance	—	1005	—	pF	V <sub>GS</sub> = 0V, V <sub>DS</sub> = 25V f = 1.0MHz
C <sub>oss</sub>	Output Capacitance	—	365	—		
C <sub>rss</sub>	Reverse Transfer Capacitance	—	50	—		

**Source-Drain Diode Ratings and Characteristics**

	Parameter	Min	Typ	Max	Units	Test Conditions
I <sub>S</sub>	Continuous Source Current (Body Diode)	—	—	22*	A	
I <sub>SM</sub>	Pulse Source Current (Body Diode) ①	—	—	88		
V <sub>SD</sub>	Diode Forward Voltage	—	—	1.2	V	T <sub>j</sub> = 25°C, I <sub>S</sub> = 22A, V <sub>GS</sub> = 0V ④
t <sub>rr</sub>	Reverse Recovery Time	—	—	250	ns	T <sub>j</sub> = 25°C, I <sub>F</sub> = 22A, di/dt ≤ 100A/μs
Q <sub>RR</sub>	Reverse Recovery Charge	—	—	850	nC	V <sub>DD</sub> ≤ 25V ④
t <sub>on</sub>	Forward Turn-On Time	Intrinsic turn-on time is negligible. Turn-on speed is substantially controlled by L <sub>S</sub> + L <sub>D</sub> .				

\* Current is limited by package

**Thermal Resistance**

	Parameter	Min	Typ	Max	Units	Test Conditions
R <sub>thJC</sub>	Junction-to-Case	—	—	1.67	°C/W	soldered to a 2" square copper-clad board
R <sub>thJ-PCB</sub>	Junction-to-PC board	—	6.9	—		

**Note:** Corresponding Spice and Saber models are available on International Rectifier Web site.

For footnotes refer to the last page

## Radiation Characteristics

## IRH NJ57130, JANSR2N7481U3

International Rectifier Radiation Hardened MOSFETs are tested to verify their radiation hardness capability. The hardness assurance program at International Rectifier is comprised of two radiation environments. Every manufacturing lot is tested for total ionizing dose (per notes 5 and 6) using the TO-3 package. Both pre- and post-irradiation performance are tested and specified using the same drive circuitry and test conditions in order to provide a direct comparison.

**Table 1. Electrical Characteristics @ Tj = 25°C, Post Total Dose Irradiation** ⑤⑥

	Parameter	Up to 500K Rads(Si) <sup>1</sup>		1000K Rads (Si) <sup>2</sup>		Units	Test Conditions
		Min	Max	Min	Max		
BV <sub>DSS</sub>	Drain-to-Source Breakdown Voltage	100	—	100	—	V	V <sub>GS</sub> = 0V, I <sub>D</sub> = 1.0mA
V <sub>GS(th)</sub>	Gate Threshold Voltage	2.0	4.0	1.5	4.0		V <sub>GS</sub> = V <sub>DS</sub> , I <sub>D</sub> = 1.0mA
I <sub>GSS</sub>	Gate-to-Source Leakage Forward	—	100	—	100	nA	V <sub>GS</sub> = 20V
I <sub>GSS</sub>	Gate-to-Source Leakage Reverse	—	-100	—	-100		V <sub>GS</sub> = -20 V
I <sub>DSS</sub>	Zero Gate Voltage Drain Current	—	10	—	25	μA	V <sub>DS</sub> = 80V, V <sub>GS</sub> = 0V
R <sub>DS(on)</sub>	Static Drain-to-Source <sup>④</sup> On-State Resistance (TO-3)	—	0.064	—	0.08	Ω	V <sub>GS</sub> = 12V, I <sub>D</sub> = 16A
R <sub>DS(on)</sub>	Static Drain-to-Source <sup>④</sup> On-State Resistance (SMD-.5)	—	0.06	—	0.075	Ω	V <sub>GS</sub> = 12V, I <sub>D</sub> = 16A
V <sub>SD</sub>	Diode Forward Voltage <sup>④</sup>	—	1.2	—	1.2	V	V <sub>GS</sub> = 0V, I <sub>S</sub> = 22A

1. Part numbers IRH NJ57130 (JANSR2N7481U3), IRH NJ53130 (JANSF2N7481U3) and IRH NJ54130 (JANS G2N7481U3)

2. Part number IRH NJ58130 (JANS H2N7481U3)

International Rectifier radiation hardened MOSFETs have been characterized in heavy ion environment for Single Event Effects (SEE). Single Event Effects characterization is illustrated in Fig. a and Table 2.

**Table 2. Typical Single Event Effect Safe Operating Area**

LET (MeV/(mg/cm <sup>2</sup> ))	Energy (MeV)	Range (μm)	VDS (V)				
			@VGS = 0V	@VGS = -5V	@VGS = -10V	@VGS = -15V	@VGS = -20V
38 ± 5%	300 ± 7.5%	38 ± 7.5%	100	100	100	100	100
61 ± 5%	330 ± 7.5%	31 ± 10%	100	100	100	35	25
84 ± 5%	350 ± 10%	28 ± 7.5%	100	100	80	25	-

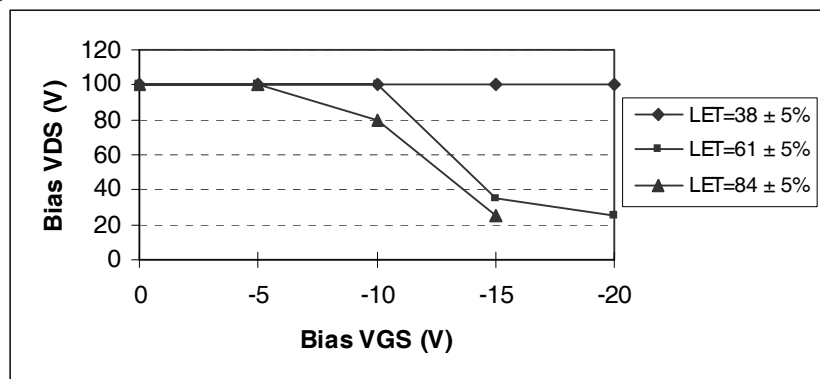

**Fig a. Typical Single Event Effect, Safe Operating Area**

For footnotes refer to the last page

www.irf.com

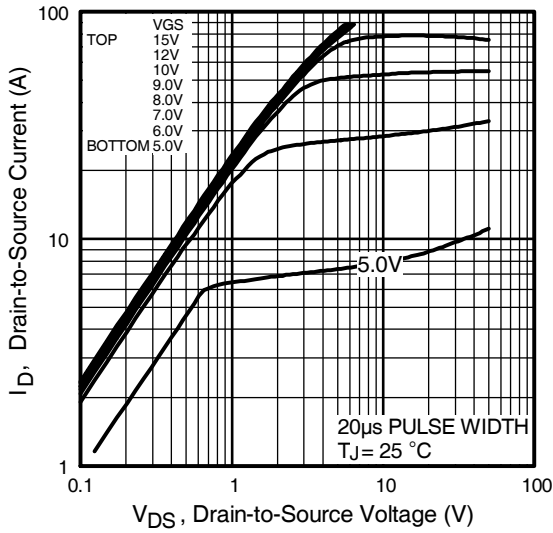

Fig 1. Typical Output Characteristics

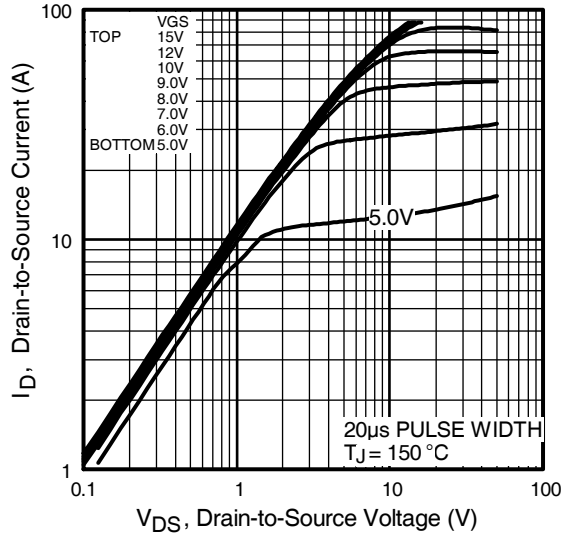

Fig 2. Typical Output Characteristics

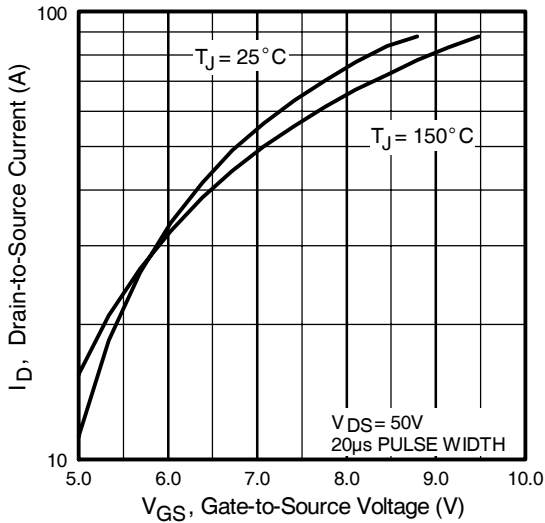

Fig 3. Typical Transfer Characteristics

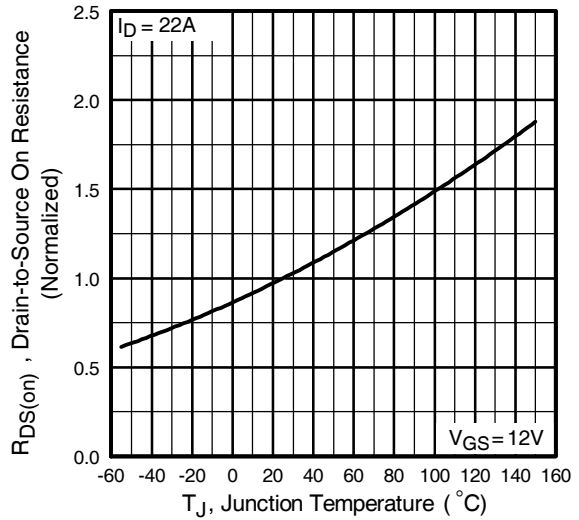

Fig 4. Normalized On-Resistance Vs. Temperature

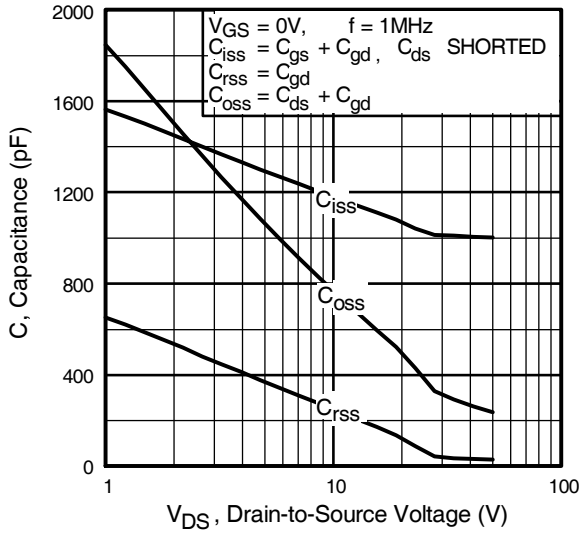

Fig 5. Typical Capacitance Vs. Drain-to-Source Voltage

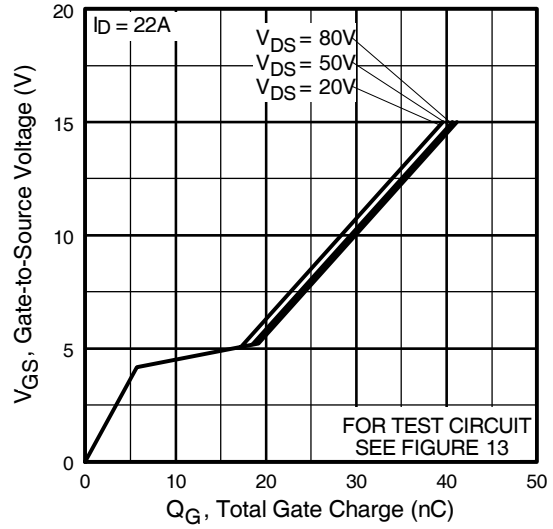

Fig 6. Typical Gate Charge Vs. Gate-to-Source Voltage

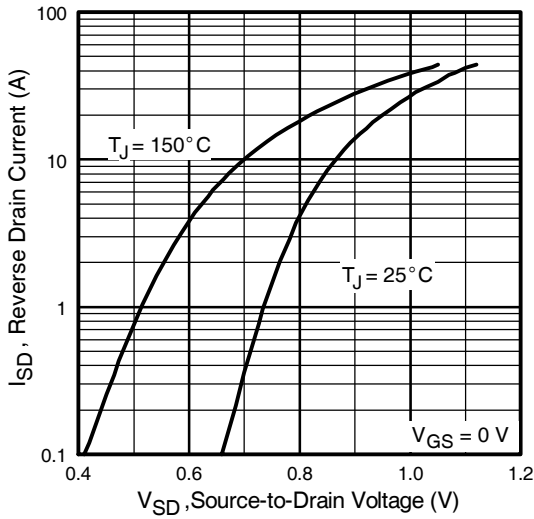

Fig 7. Typical Source-Drain Diode Forward Voltage

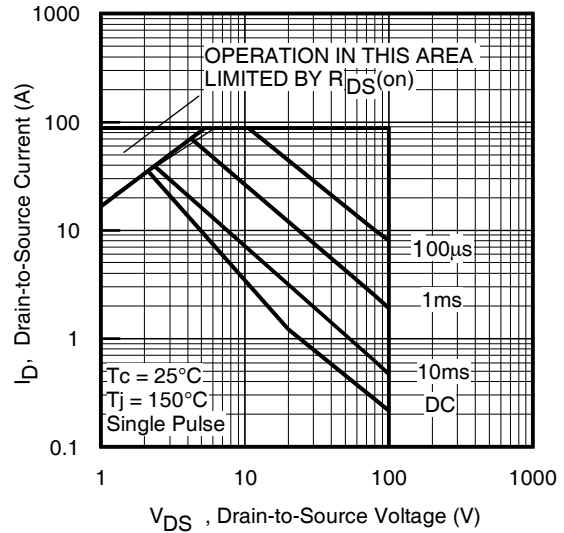
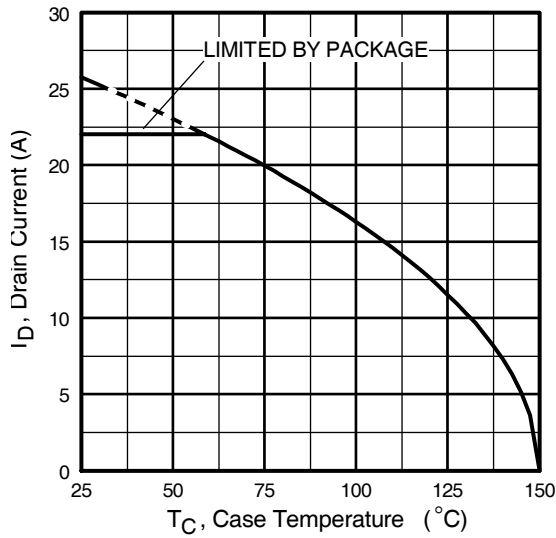
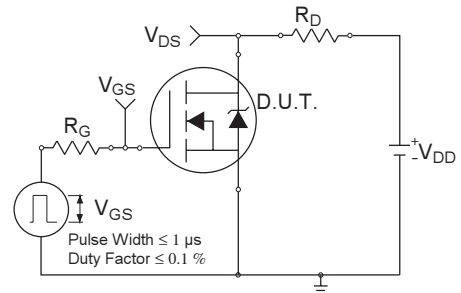

Fig 8. Maximum Safe Operating Area



**Fig 9.** Maximum Drain Current Vs. Case Temperature



**Fig 10a.** Switching Time Test Circuit

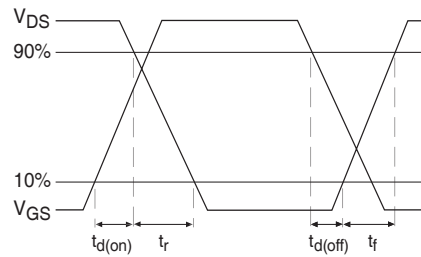

**Fig 10b.** Switching Time Waveforms

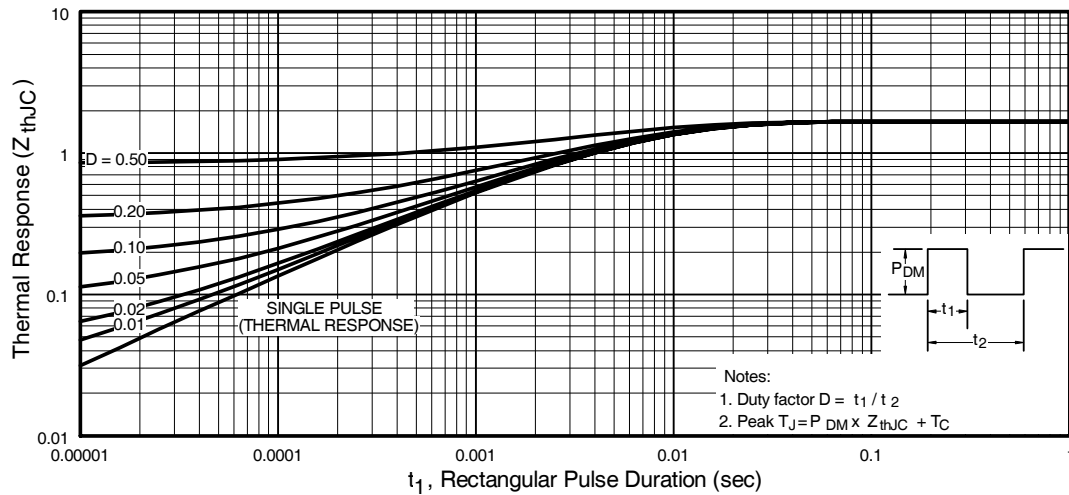

**Fig 11.** Maximum Effective Transient Thermal Impedance, Junction-to-Case

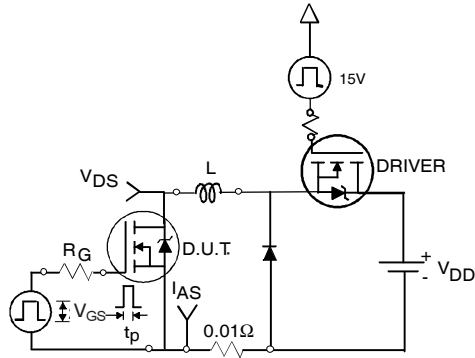

Fig 12a. Unclamped Inductive Test Circuit



Fig 12b. Unclamped Inductive Waveforms

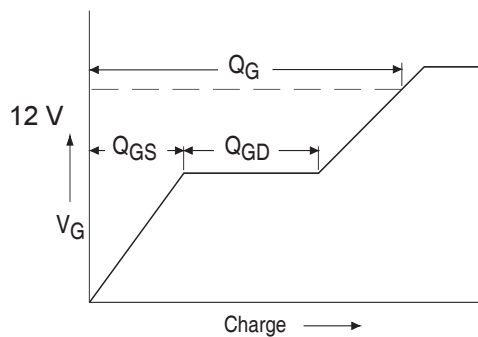

Fig 13a. Basic Gate Charge Waveform

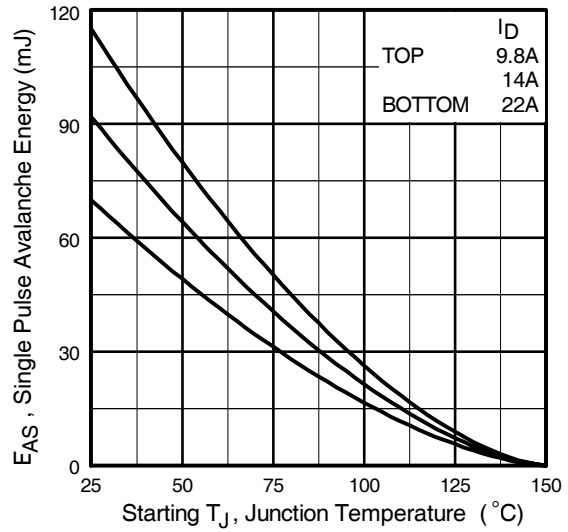

Fig 12c. Maximum Avalanche Energy Vs. Drain Current

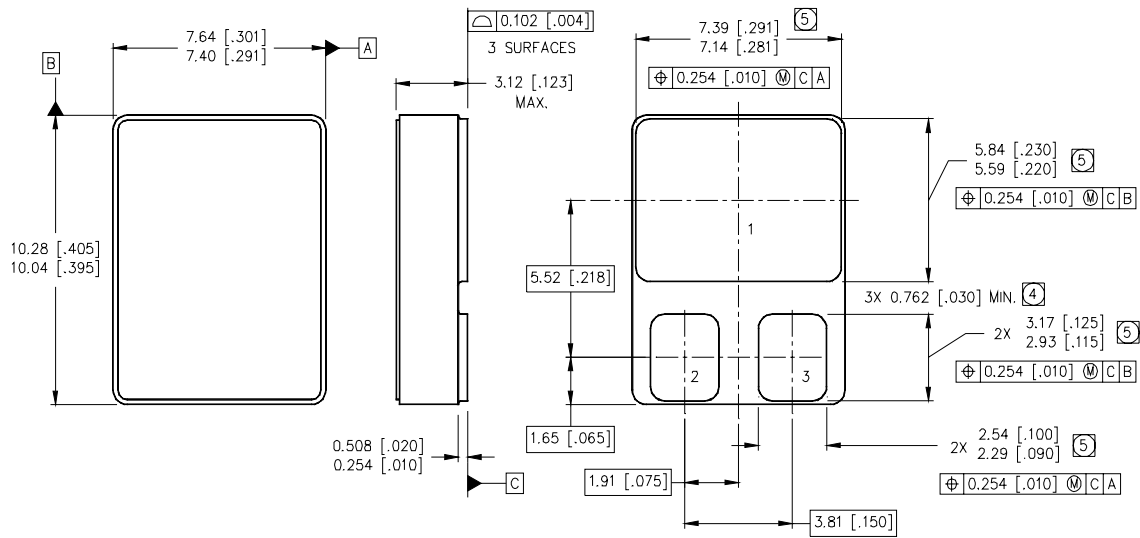

Fig 13b. Gate Charge Test Circuit

**Footnotes:**

- ① Repetitive Rating; Pulse width limited by maximum junction temperature.
- ②  $V_{DD} = 50V$ , starting  $T_J = 25^\circ C$ ,  $L = 0.3\text{ mH}$   
Peak  $I_L = 22A$ ,  $V_{GS} = 12V$
- ③  $I_{SD} \leq 22A$ ,  $di/dt \leq 155A/\mu s$ ,  
 $V_{DD} \leq 100V$ ,  $T_J \leq 150^\circ C$
- ④ Pulse width  $\leq 300\ \mu s$ ; Duty Cycle  $\leq 2\%$
- ⑤ **Total Dose Irradiation with  $V_{GS}$  Bias.**  
12 volt  $V_{GS}$  applied and  $V_{DS} = 0$  during irradiation per MIL-STD-750, method 1019, condition A.
- ⑥ **Total Dose Irradiation with  $V_{DS}$  Bias.**  
80 volt  $V_{DS}$  applied and  $V_{GS} = 0$  during irradiation per MIL-STD-750, method 1019, condition A.

**Case Outline and Dimensions — SMD-0.5**



NOTES:

- 1. DIMENSIONING & TOLERANCING PER ASME Y14.5M-1994.
- 2. CONTROLLING DIMENSION: INCH.
- 3. DIMENSIONS ARE SHOWN IN MILLIMETERS [INCHES].
- ④ DIMENSION INCLUDES METALLIZATION FLASH.
- ⑤ DIMENSION DOES NOT INCLUDE METALLIZATION FLASH.

PAD ASSIGNMENTS

- 1 = DRAIN
- 2 = GATE
- 3 = SOURCE

International  
**IOR** Rectifier

**IR WORLD HEADQUARTERS:** 233 Kansas St., El Segundo, California 90245, USA Tel: (310) 252-7105  
**IR LEOMINSTER :** 205 Crawford St., Leominster, Massachusetts 01453, USA Tel: (978) 534-5776  
 TAC Fax: (310) 252-7903

Visit us at [www.irf.com](http://www.irf.com) for sales contact information.  
 Data and specifications subject to change without notice. 10/2011