

## RADIATION HARDENED POWER MOSFET SURFACE MOUNT (SMD-1)

## IRHN7450SE 500V, N-CHANNEL RAD Hard™ HEXFET® TECHNOLOGY

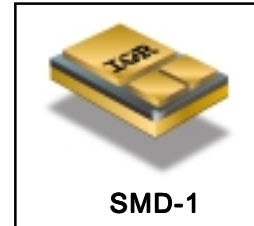

### Product Summary

Part Number	Radiation Level	RDS(on)	ID
IRHN7450SE	100K Rads (Si)	0.51Ω	12A

International Rectifier's RADHard™ HEXFET® MOSFET technology provides high performance power MOSFETs for space applications. This technology has over a decade of proven performance and reliability in satellite applications. These devices have been characterized for both Total Dose and Single Event Effects (SEE). The combination of low RDS(on) and low gate charge reduces the power losses in switching applications such as DC to DC converters and motor control. These devices retain all of the well established advantages of MOSFETs such as voltage control, fast switching, ease of paralleling and temperature stability of electrical parameters.

### Features:

- Single Event Effect (SEE) Hardened
- Ultra Low RDS(on)
- Low Total Gate Charge
- Proton Tolerant
- Simple Drive Requirements
- Ease of Paralleling
- Hermetically Sealed
- Surface Mount
- Light Weight

### Absolute Maximum Ratings

### Pre-Irradiation

	Parameter		Units
ID @ VGS = 12V, TC = 25°C	Continuous Drain Current	12	A
ID @ VGS = 12V, TC = 100°C	Continuous Drain Current	7.0	
IDM	Pulsed Drain Current ①	48	
PD @ TC = 25°C	Max. Power Dissipation	151	W
	Linear Derating Factor	1.2	W/°C
VGS	Gate-to-Source Voltage	±20	V
EAS	Single Pulse Avalanche Energy ②	500	mJ
IAR	Avalanche Current ①	12	A
EAR	Repetitive Avalanche Energy ①	15	mJ
dv/dt	Peak Diode Recovery dv/dt ③	4.2	V/ns
TJ	Operating Junction	-55 to 150	°C
TSTG	Storage Temperature Range		
	Package Mounting Surface Temperature	300 (for 5 sec.)	
	Weight	2.6 (Typical)	g

For footnotes refer to the last page

Electrical Characteristics @ T<sub>j</sub> = 25°C (Unless Otherwise Specified)

	Parameter	Min	Typ	Max	Units	Test Conditions
BVDSS	Drain-to-Source Breakdown Voltage	500	—	—	V	V <sub>GS</sub> = 0V, I <sub>D</sub> = 1.0mA
ΔBVDSS/ΔT <sub>J</sub>	Temperature Coefficient of Breakdown Voltage	—	0.6	—	V/°C	Reference to 25°C, I <sub>D</sub> = 1.0mA
RDS(on)	Static Drain-to-Source On-State Resistance	—	—	0.51	Ω	V <sub>GS</sub> = 12V, I <sub>D</sub> = 7.0A ④
		—	—	0.57		V <sub>GS</sub> = 12V, I <sub>D</sub> = 12A
VGS(th)	Gate Threshold Voltage	2.5	—	4.5	V	V <sub>DS</sub> = V <sub>GS</sub> , I <sub>D</sub> = 1.0mA
gfs	Forward Transconductance	3.0	—	—	S (τ)	V <sub>DS</sub> > 15V, I <sub>DS</sub> = 7.0A ④
IDSS	Zero Gate Voltage Drain Current	—	—	50	μA	V <sub>DS</sub> = 400V, V <sub>GS</sub> = 0V
		—	—	250		V <sub>DS</sub> = 400V, V <sub>GS</sub> = 0V, T <sub>J</sub> = 125°C
IGSS	Gate-to-Source Leakage Forward	—	—	100	nA	V <sub>GS</sub> = 20V
IGSS	Gate-to-Source Leakage Reverse	—	—	-100		V <sub>GS</sub> = -20V
Qg	Total Gate Charge	—	—	140	nC	V <sub>GS</sub> = 12V, I <sub>D</sub> = 12A V <sub>DS</sub> = 250V
Qgs	Gate-to-Source Charge	—	—	35		
Qgd	Gate-to-Drain ('Miller') Charge	—	—	75		
td(on)	Turn-On Delay Time	—	—	35	ns	V <sub>DD</sub> = 250V, I <sub>D</sub> = 12A, V <sub>GS</sub> = 12V, R <sub>G</sub> = 2.35Ω
tr	Rise Time	—	—	60		
td(off)	Turn-Off Delay Time	—	—	75		
tf	Fall Time	—	—	60		
LS + LD	Total Inductance	—	4.0	—	nH	Measured from the center of drain pad to center of source pad
Ciss	Input Capacitance	—	2800	—	pF	V <sub>GS</sub> = 0V, V <sub>DS</sub> = 25V f = 1.0MHz
Coss	Output Capacitance	—	640	—		
Crss	Reverse Transfer Capacitance	—	250	—		

## Source-Drain Diode Ratings and Characteristics

	Parameter	Min	Typ	Max	Units	Test Conditions
IS	Continuous Source Current (Body Diode)	—	—	12	A	
ISM	Pulse Source Current (Body Diode) ①	—	—	48		
VSD	Diode Forward Voltage	—	—	1.6	V	T <sub>J</sub> = 25°C, I <sub>S</sub> = 12A, V <sub>GS</sub> = 0V ④
trr	Reverse Recovery Time	—	—	500	nS	T <sub>J</sub> = 25°C, I <sub>F</sub> = 12A, di/dt ≤ 100A/μs
QRR	Reverse Recovery Charge	—	—	9.6	μC	V <sub>DD</sub> ≤ 50V ④
ton	Forward Turn-On Time	Intrinsic turn-on time is negligible. Turn-on speed is substantially controlled by LS + LD.				

## Thermal Resistance

	Parameter	Min	Typ	Max	Units	Test Conditions
RthJC	Junction-to-Case	—	—	0.83	°C/W	Soldered to a 1 inch square clad PC board
RthJ-PCB	Junction-to-PC board	—	6.6	—		

Note: Corresponding Spice and Saber models are available on the G&S Website.

For footnotes refer to the last page

International Rectifier Radiation Hardened MOSFETs are tested to verify their radiation hardness capability. The hardness assurance program at International Rectifier is comprised of two radiation environments. Every manufacturing lot is tested for total ionizing dose (per notes 5 and 6) using the TO-3 package. Both pre- and post-irradiation performance are tested and specified using the same drive circuitry and test conditions in order to provide a direct comparison.

**Table 1. Electrical Characteristics @ Tj = 25°C, Post Total Dose Irradiation ⑤⑥**

	Parameter	100K Rads (Si)		Units	Test Conditions ⑧
		Min	Max		
BV <sub>DSS</sub>	Drain-to-Source Breakdown Voltage	500	—	V	V <sub>GS</sub> = 0V, I <sub>D</sub> = 1.0mA
V <sub>GS(th)</sub>	Gate Threshold Voltage	2.0	4.5		V <sub>GS</sub> = V <sub>DS</sub> , I <sub>D</sub> = 1.0mA
I <sub>GSS</sub>	Gate-to-Source Leakage Forward	—	100	nA	V <sub>GS</sub> = 20V
I <sub>GSS</sub>	Gate-to-Source Leakage Reverse	—	-100		V <sub>GS</sub> = -20V
I <sub>DSS</sub>	Zero Gate Voltage Drain Current	—	50	μA	V <sub>DS</sub> = 400V, V <sub>GS</sub> = 0V
R <sub>DS(on)</sub>	Static Drain-to-Source ④ On-State Resistance (TO-3)	—	0.51	Ω	V <sub>GS</sub> = 12V, I <sub>D</sub> = 7.0A
R <sub>DS(on)</sub>	Static Drain-to-Source ④ On-State Resistance (SMD-1)	—	0.51	Ω	V <sub>GS</sub> = 12V, I <sub>D</sub> = 7.0A
V <sub>SD</sub>	Diode Forward Voltage ④	—	1.6	V	V <sub>GS</sub> = 0V, I <sub>D</sub> = 12A

International Rectifier radiation hardened MOSFETs have been characterized in heavy ion environment for Single Event Effects (SEE). Single Event Effects characterization is illustrated in Fig. a and Table 2.

**Table 2. Single Event Effect Safe Operating Area**

Ion	LET MeV/(mg/cm <sup>2</sup> )	Energy (MeV)	Range (μm)	V <sub>DS</sub> (V)				
				@V <sub>GS</sub> =0V	@V <sub>GS</sub> =-5V	@V <sub>GS</sub> =-10V	@V <sub>GS</sub> =-15V	@V <sub>GS</sub> =-20V
Cu	28	285	43	375	375	375	375	375
Br	36.8	305	39	350	350	350	325	300
Ni	26.6	265	42	—	375	—	—	—

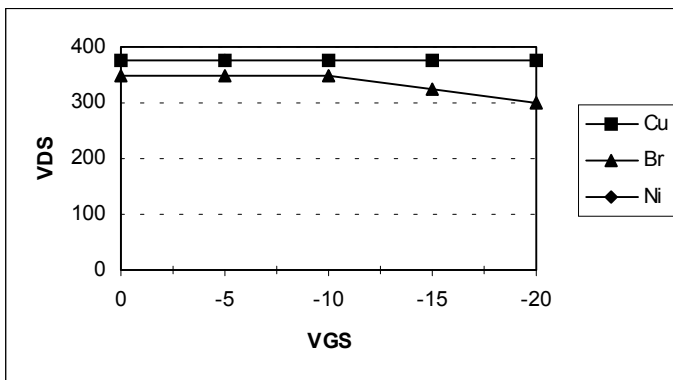

**Fig a. Single Event Effect, Safe Operating Area**

For footnotes refer to the last page

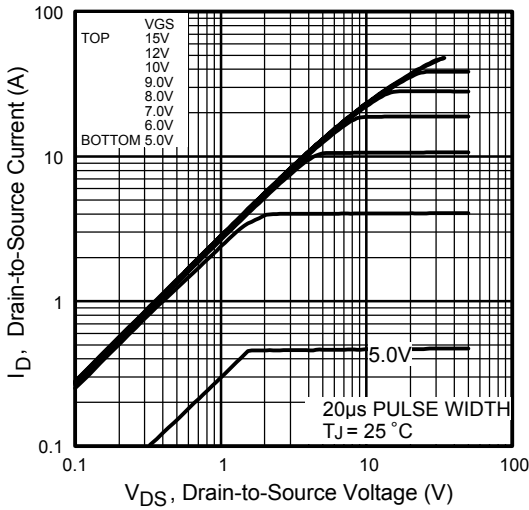

Fig 1. Typical Output Characteristics

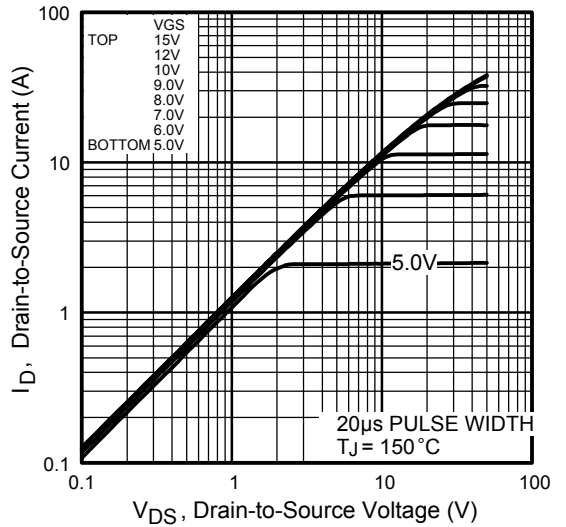

Fig 2. Typical Output Characteristics

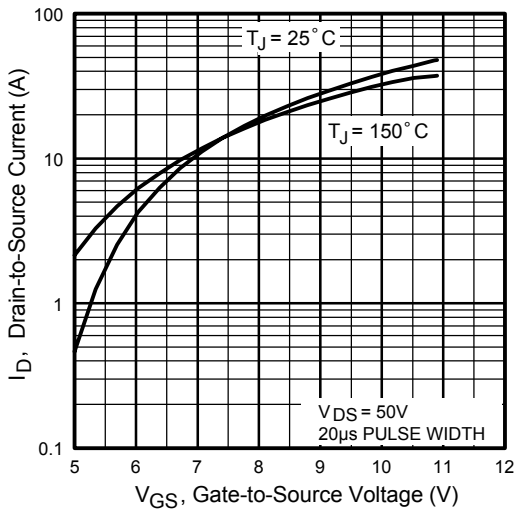

Fig 3. Typical Transfer Characteristics

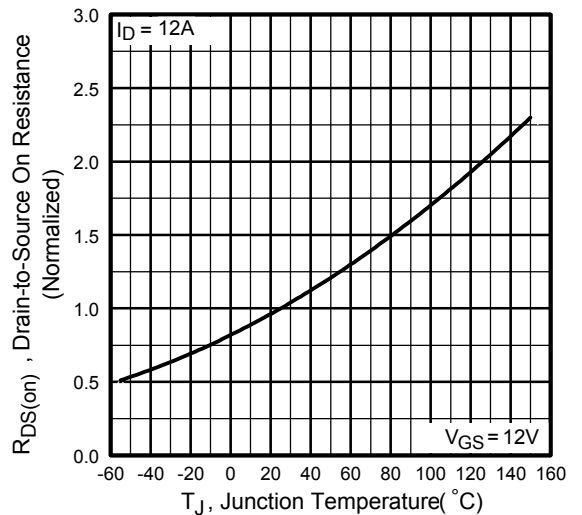

Fig 4. Normalized On-Resistance Vs. Temperature

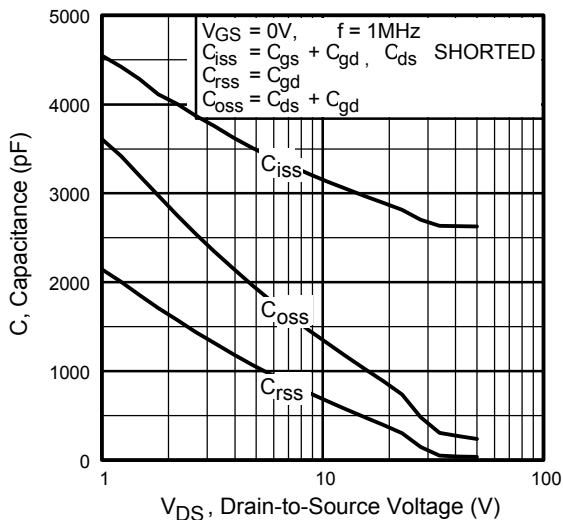

Fig 5. Typical Capacitance Vs. Drain-to-Source Voltage

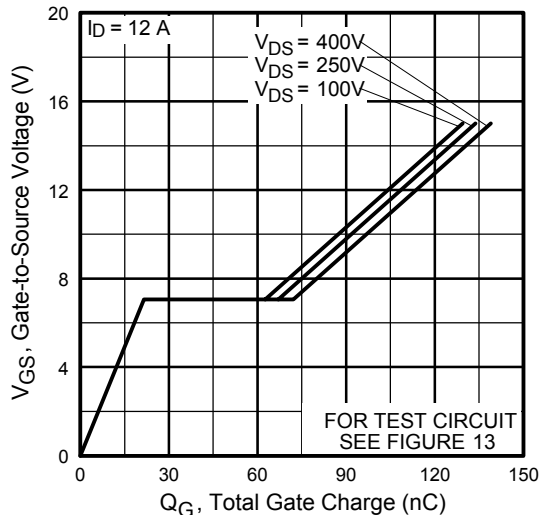

Fig 6. Typical Gate Charge Vs. Gate-to-Source Voltage

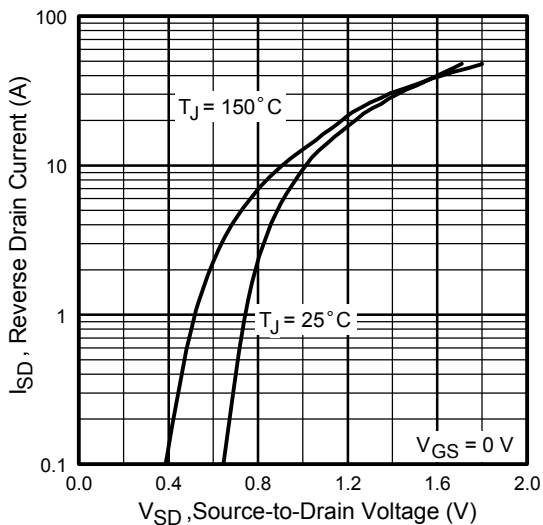

Fig 7. Typical Source-Drain Diode Forward Voltage

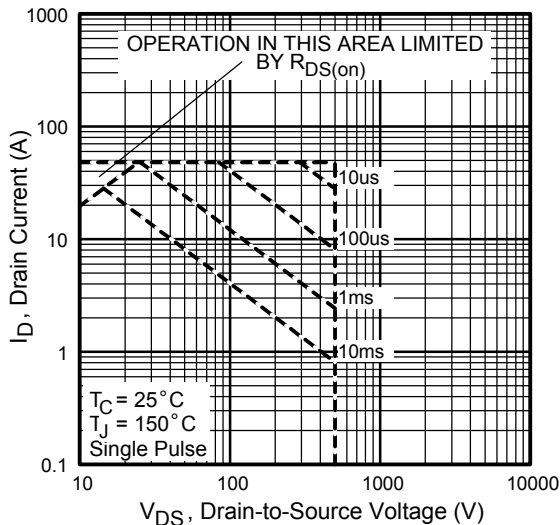

Fig 8. Maximum Safe Operating Area

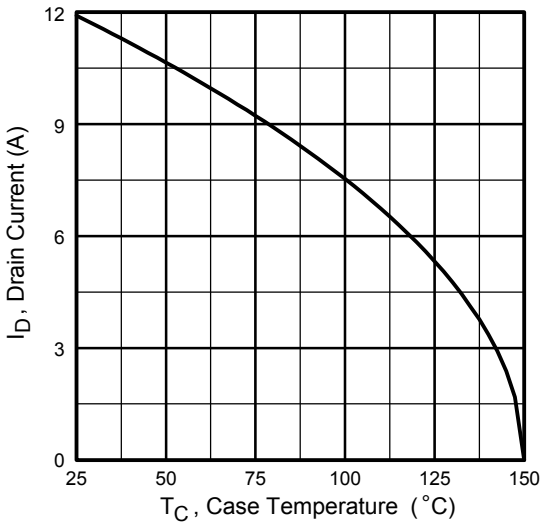

Fig 9. Maximum Drain Current Vs. Case Temperature

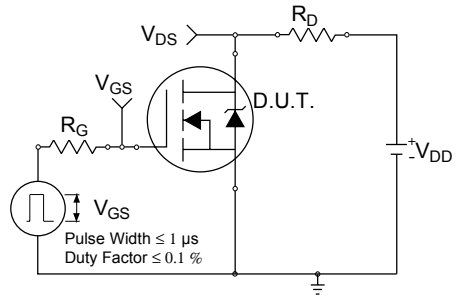

Fig 10a. Switching Time Test Circuit

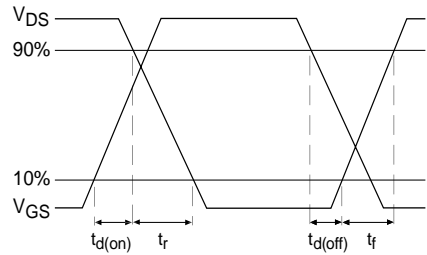

Fig 10b. Switching Time Waveforms

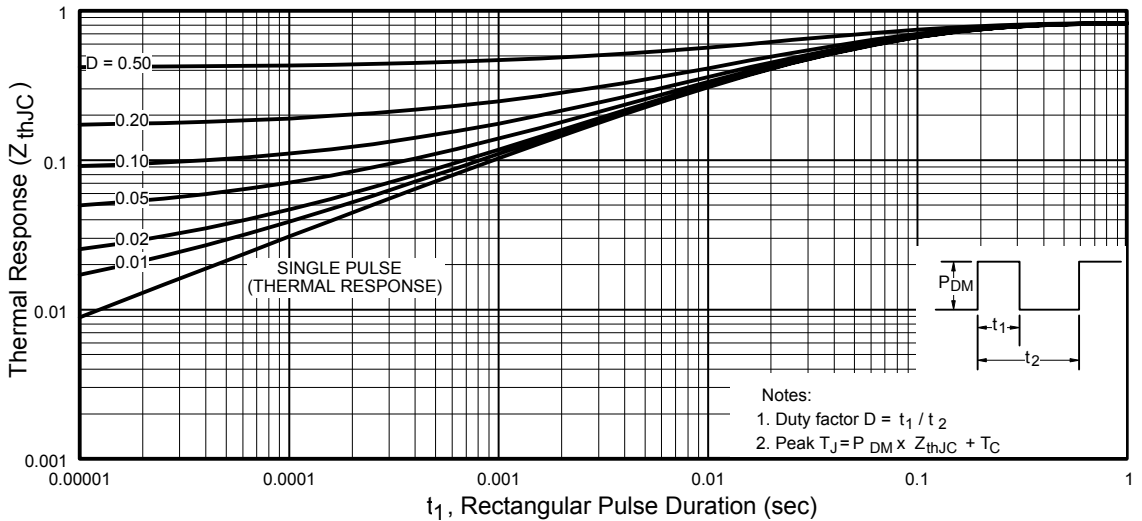

Fig 11. Maximum Effective Transient Thermal Impedance, Junction-to-Case

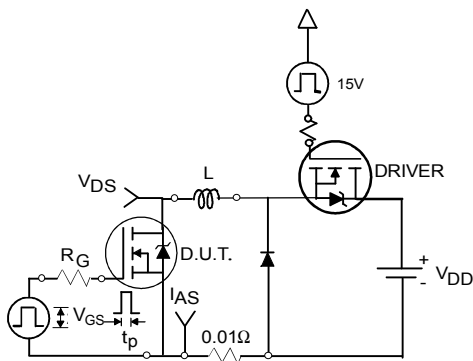

Fig 12a. Unclamped Inductive Test Circuit

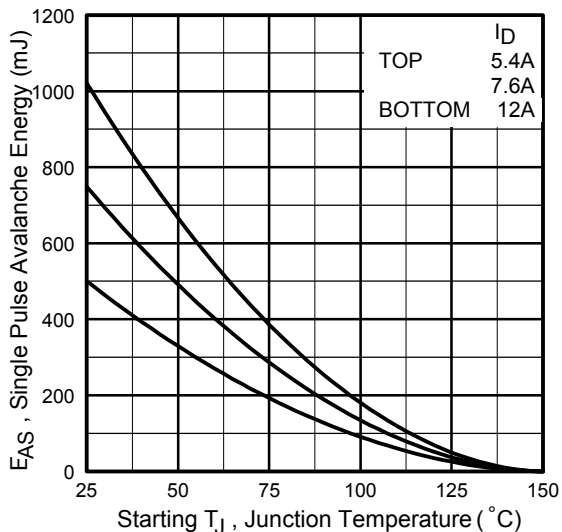

Fig 12c. Maximum Avalanche Energy Vs. Drain Current

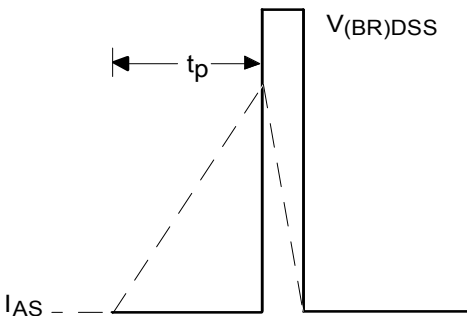

Fig 12b. Unclamped Inductive Waveforms

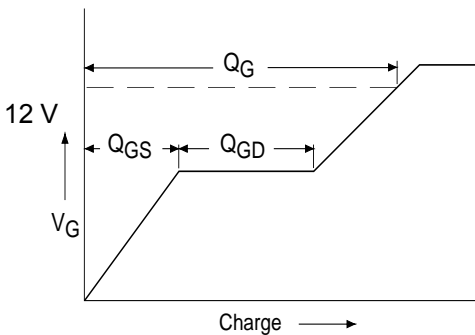

Fig 13a. Basic Gate Charge Waveform

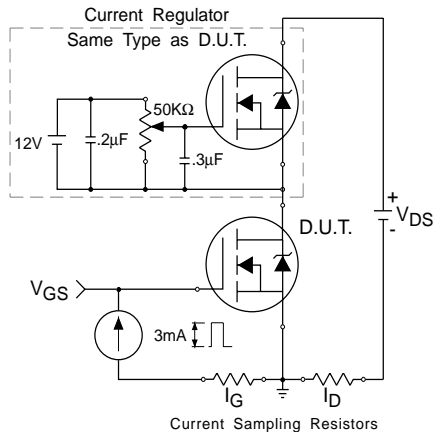
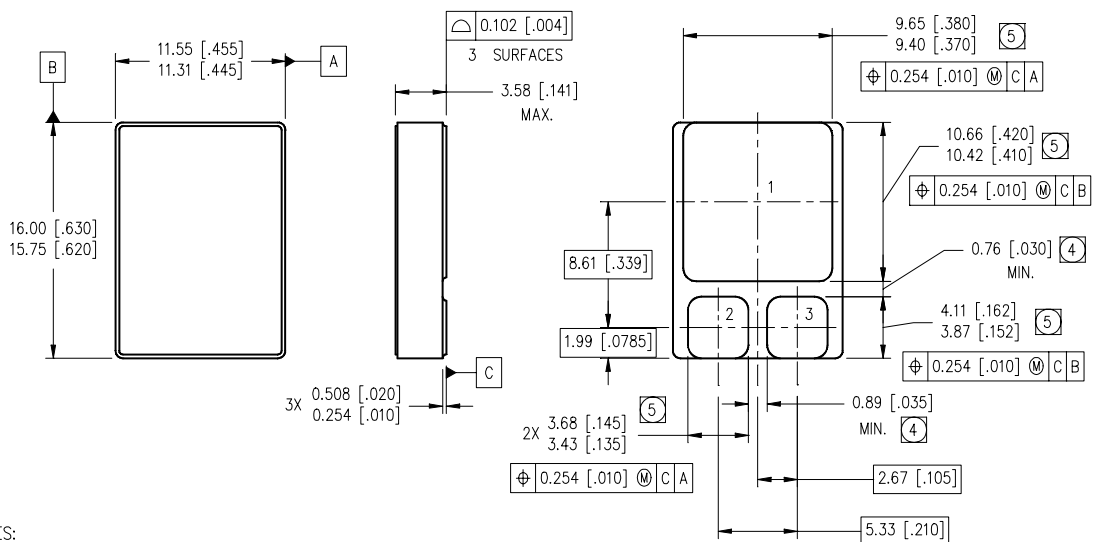

Fig 13b. Gate Charge Test Circuit

Footnotes:

- ① Repetitive Rating; Pulse width limited by maximum junction temperature.
- ②  $V_{DD} = 50V$ , starting  $T_J = 25^{\circ}C$ ,  $L = 6.9\text{ mH}$   
Peak  $I_L = 12A$ ,  $V_{GS} = 12V$
- ③  $I_{SD} \leq 12A$ ,  $di/dt \leq 400A/\mu s$ ,  
 $V_{DD} \leq 500V$ ,  $T_J \leq 150^{\circ}C$
- ④ Pulse width  $\leq 300\ \mu s$ ; Duty Cycle  $\leq 2\%$
- ⑤ **Total Dose Irradiation with  $V_{GS}$  Bias.**  
12 volt  $V_{GS}$  applied and  $V_{DS} = 0$  during irradiation per MIL-STD-750, method 1019, condition A.
- ⑥ **Total Dose Irradiation with  $V_{DS}$  Bias.**  
400 volt  $V_{DS}$  applied and  $V_{GS} = 0$  during irradiation per MIL-STD-750, method 1019, condition A.

Case Outline and Dimensions —SMD-1



NOTES:

- 1. DIMENSIONING & TOLERANCING PER ASME Y14.5M-1994.
- 2. CONTROLLING DIMENSION: INCH.
- 3. DIMENSIONS ARE SHOWN IN MILLIMETERS [INCHES].
- ④ DIMENSION INCLUDES METALLIZATION FLASH.
- ⑤ DIMENSION DOES NOT INCLUDE METALLIZATION FLASH.

PAD ASSIGNMENTS

- 1 = DRAIN
- 2 = GATE
- 3 = SOURCE

International  
**IR** Rectifier

IR WORLD HEADQUARTERS: 233 Kansas St., El Segundo, California 90245, USA Tel: (310) 252-7105  
 TAC Fax: (310) 252-7903

Visit us at [www.irf.com](http://www.irf.com) for sales contact information.  
 Data and specifications subject to change without notice. 05/01