

**RADIATION HARDENED
LOGIC LEVEL POWER MOSFET
SURFACE-MOUNT (SMD-2)**

60V, P-CHANNEL
R7 TECHNOLOGY

Product Summary

Part Number	Radiation Level	RDS(on)	I _D
IRHLNA797064	100 kRads(Si)	0.017Ω	-56A*
IRHLNA793064	300 kRads(Si)	0.017Ω	-56A*

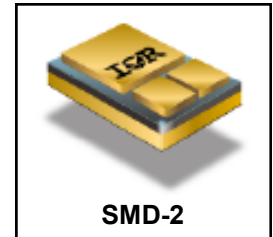

Description

IR HiRel R7 Logic Level Power MOSFETs provide simple solution to interfacing CMOS and TTL control circuits to power devices in space and other radiation environments. The threshold voltage remains within acceptable operating limits over the full operating temperature and post radiation. This is achieved while maintaining single event gate rupture and single event burnout immunity.

The device is ideal when used to interface directly with most logic gates, linear IC's, micro-controllers, and other device types that operate from a 3.3-5V source. It may also be used to increase the output current of a PWM, voltage comparator or an operational amplifier where the logic level drive signal is available.

Features

- Low RDS(on)
- Fast Switching
- Single Event Effect (SEE) Hardened
- Low Total Gate Charge
- Simple Drive Requirements
- Hermetically Sealed
- Ceramic Package
- Surface Mount
- Light Weight
- ESD Rating: Class 3B per MIL-STD-750, Method 1020

Absolute Maximum Ratings

Pre-Irradiation

Symbol	Parameter	Value	Units
I _{D1} @ V _{GS} = 4.5V, T _C = 25°C	Continuous Drain Current	-56*	A
I _{D2} @ V _{GS} = 4.5V, T _C = 100°C	Continuous Drain Current	-56*	
I _{DM} @ T _C = 25°C	Pulsed Drain Current ①	-224	
P _D @ T _C = 25°C	Maximum Power Dissipation	250	W
	Linear Derating Factor	1.67	W/°C
V _{GS}	Gate-to-Source Voltage	±10	V
E _{AS}	Single Pulse Avalanche Energy ②	1060	mJ
I _{AR}	Avalanche Current ①	-56	A
E _{AR}	Repetitive Avalanche Energy ①	25	mJ
dv/dt	Peak Diode Recovery dv/dt ③	-3.7	V/ns
T _J T _{STG}	Operating Junction and Storage Temperature Range	-55 to +150	°C
	Package Mounting Surface Temp.	300 (for 5s)	
	Weight	3.3 (Typical)	

*Current is limited by package
For footnotes refer to the page 2.

Electrical Characteristics @ T_j = 25°C (Unless Otherwise Specified)

Symbol	Parameter	Min.	Typ.	Max.	Units	Test Conditions
BV _{DSS}	Drain-to-Source Breakdown Voltage	-60	—	—	V	V _{GS} = 0V, I _D = -250μA
ΔBV _{DSS} /ΔT _J	Breakdown Voltage Temp. Coefficient	—	-0.06	—	V/°C	Reference to 25°C, I _D = -1.0mA
R _{DS(on)}	Static Drain-to-Source On-Resistance	—	—	0.017	Ω	V _{GS} = -4.5V, I _{D2} = -56A ④
V _{GS(th)}	Gate Threshold Voltage	-1.0	—	-2.0	V	V _{DS} = V _{GS} , I _D = -250μA
ΔV _{GS(th)} /ΔT _J	Gate Threshold Voltage Coefficient	—	4.1	—	mV/°C	
g _{fs}	Forward Transconductance	65	—	—	S	V _{DS} = -15V, I _{D2} = -56A ④
I _{DSS}	Zero Gate Voltage Drain Current	—	—	-1.0	μA	V _{DS} = -48V, V _{GS} = 0V
		—	—	-25		V _{DS} = -48V, V _{GS} = 0V, T _J = 125°C
I _{GSS}	Gate-to-Source Leakage Forward	—	—	-100	nA	V _{GS} = -10V
	Gate-to-Source Leakage Reverse	—	—	100		V _{GS} = 10V
Q _G	Total Gate Charge	—	—	130	nC	I _{D1} = -56A
Q _{GS}	Gate-to-Source Charge	—	—	35		V _{DS} = -30V
Q _{GD}	Gate-to-Drain ('Miller') Charge	—	—	55		V _{GS} = -4.5V
t _{d(on)}	Turn-On Delay Time	—	—	38	ns	V _{DD} = -30V
t _r	Rise Time	—	—	265		I _{D1} = -56A
t _{d(off)}	Turn-Off Delay Time	—	—	210		R _G = 2.35Ω
t _f	Fall Time	—	—	70		V _{GS} = -4.5V
L _S + L _D	Total Inductance	—	4.0	—	nH	Measured from center of Drain pad to center of Source pad
C _{iss}	Input Capacitance	—	10520	—	pF	V _{GS} = 0V
C _{oss}	Output Capacitance	—	2780	—		V _{DS} = -25V
C _{rss}	Reverse Transfer Capacitance	—	310	—		f = 1.0MHz
R _G	Gate Resistance	—	2.3	—	Ω	f = 1.0MHz, open drain

Source-Drain Diode Ratings and Characteristics

Symbol	Parameter	Min.	Typ.	Max.	Units	Test Conditions
I _S	Continuous Source Current (Body Diode)	—	—	-56*	A	
I _{SM}	Pulsed Source Current (Body Diode) ①	—	—	-224		
V _{SD}	Diode Forward Voltage	—	—	-5.0	V	T _J = 25°C, I _S = -56A, V _{GS} = 0V ④
t _{rr}	Reverse Recovery Time	—	—	150	ns	T _J = 25°C, I _F = -56A, V _{DD} ≤ -25V
Q _{rr}	Reverse Recovery Charge	—	—	430	μC	di/dt = -100A/μs ④
t _{on}	Forward Turn-On Time	Intrinsic turn-on time is negligible (turn-on is dominated by L _S +L _D)				

* Current is limited by package

Thermal Resistance

Symbol	Parameter	Min.	Typ.	Max.	Units
R _{θJC}	Junction-to-Case	—	—	0.5	°C/W
R _{θJ-PCB}	Case -to-PC Board	—	—	1.6	

Footnotes:

- ① Repetitive Rating; Pulse width limited by maximum junction temperature.
- ② V_{DD} = -50V, starting T_J = 25°C, L = 0.67mH, Peak I_L = -56A, V_{GS} = -10V
- ③ I_{SD} ≤ -56A, di/dt ≤ -380A/μs, V_{DD} ≤ -60V, T_J ≤ 150°C
- ④ Pulse width ≤ 300 μs; Duty Cycle ≤ 2%
- ⑤ Total Dose Irradiation with V_{GS} Bias. -10 volt V_{GS} applied and V_{DS} = 0 during irradiation per MIL-STD-750, Method 1019, condition A.
- ⑥ Total Dose Irradiation with V_{DS} Bias. -48 volt V_{DS} applied and V_{GS} = 0 during irradiation per MIL-STD-750, Method 1019, condition A.

Radiation Characteristics

IR HiRel Radiation Hardened MOSFETs are tested to verify their radiation hardness capability. The hardness assurance program at International Rectifier is comprised of two radiation environments. Every manufacturing lot is tested for total ionizing dose (per notes 5 and 6) using the TO-3 package. Both pre- and post-irradiation performance are tested and specified using the same drive circuitry and test conditions in order to provide a direct comparison.

Table 1. Electrical Characteristics @ Tj = 25°C, Post Total Dose Irradiation ⑤⑥

Symbol	Parameter	Up to 300 kRads(Si) ¹		Units	Test Conditions
		Min.	Max.		
BV _{DSS}	Drain-to-Source Breakdown Voltage	-60	—	V	V _{GS} = 0V, I _D = -250μA
V _{GS(th)}	Gate Threshold Voltage	-1.0	-2.0	V	V _{DS} = V _{GS} , I _D = -250μA
I _{GSS}	Gate-to-Source Leakage Forward	—	-100	nA	V _{GS} = -10V
I _{GSS}	Gate-to-Source Leakage Reverse	—	100	nA	V _{GS} = 10V
I _{DSS}	Zero Gate Voltage Drain Current	—	-10	μA	V _{DS} = -48V, V _{GS} = 0V
R _{DS(on)}	Static Drain-to-Source On-State Resistance (TO-3) ④	—	0.019	Ω	V _{GS} = -4.5V, I _{D2} = -56A
R _{DS(on)}	Static Drain-to-Source On-State Resistance (SMD-2) ④	—	0.017	Ω	V _{GS} = -4.5V, I _{D2} = -56A
V _{SD}	Diode Forward Voltage	—	-5.0	V	V _{GS} = 0V, I _S = -56A

1. Part numbers IRHLNA797064 and IRHLNA793064

IR HiRel radiation hardened MOSFETs have been characterized in heavy ion environment for Single Event Effects (SEE). Single Event Effects characterization is illustrated in Fig. a and Table 2.

Table 2. Typical Single Event Effect Safe Operating Area

LET (MeV/(mg/cm ²))	Energy (MeV)	Range (μm)	V _{DS} (V)					
			@VGS= 0V	@VGS= 2V	@VGS= 3V	@VGS= 4V	@VGS= 5V	@VGS= 6V
39.0 ± 5%	312 ± 7.5%	38.6 ± 7.5%	-60	-60	-60	-60	-60	-60
61.7 ± 5%	584 ± 7.5%	48.7 ± 7.5%	-60	-60	-60	-60	—	—
91.5 ± 5%	1262 ± 7.5%	70.1 ± 7.5%	-40	—	—	—	—	—

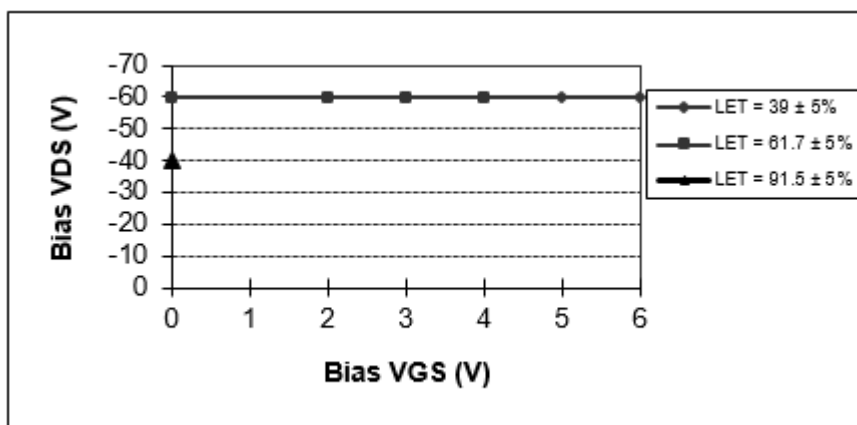

Fig a. Typical Single Event Effect, Safe Operating Area

For footnotes refer to the page 2.

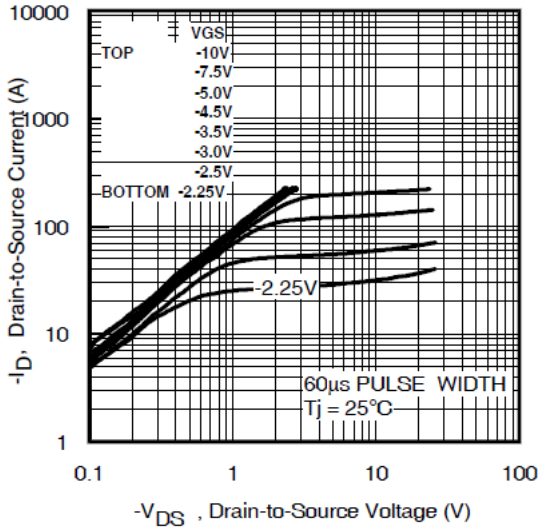

Fig 1. Typical Output Characteristics

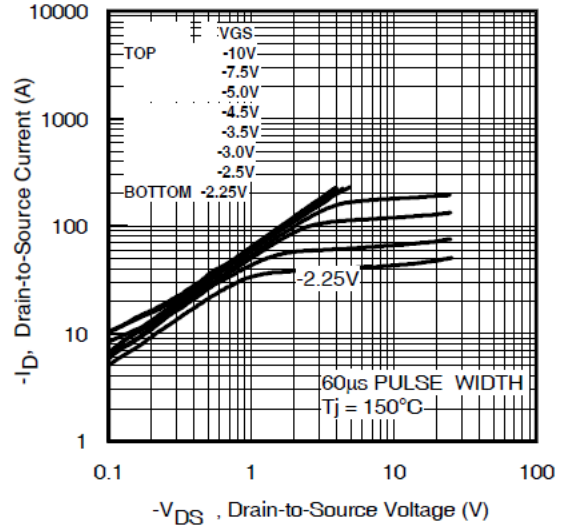

Fig 2. Typical Output Characteristics

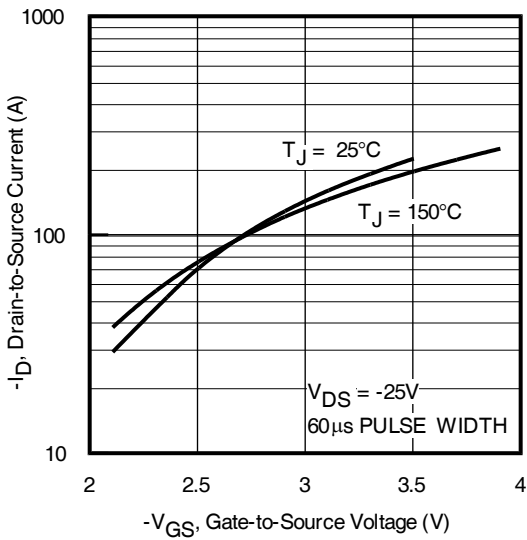

Fig 3. Typical Transfer Characteristics

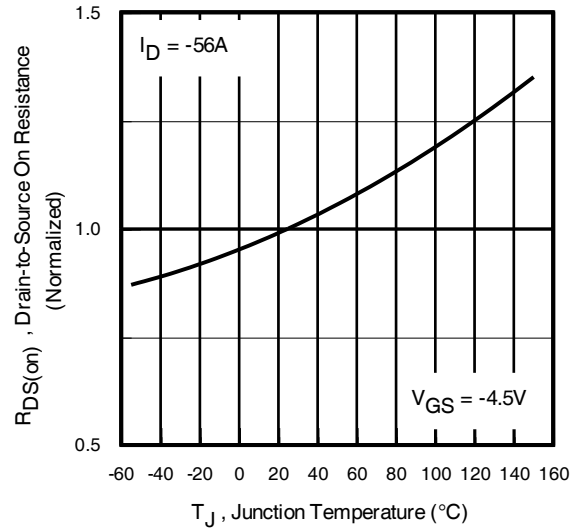

Fig 4. Normalized On-Resistance Vs. Temperature

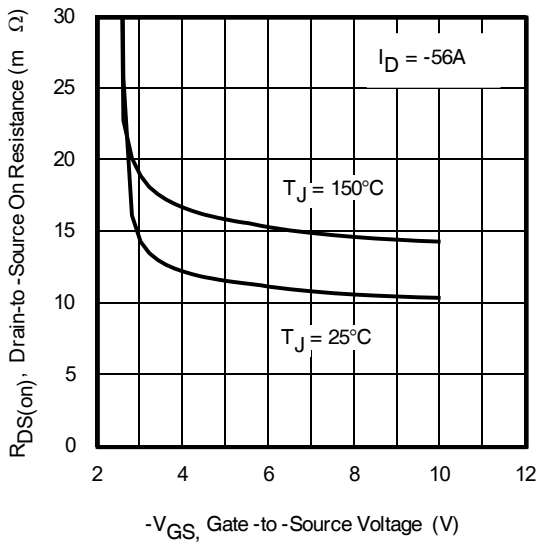

Fig 5. Typical On-Resistance Vs Gate Voltage

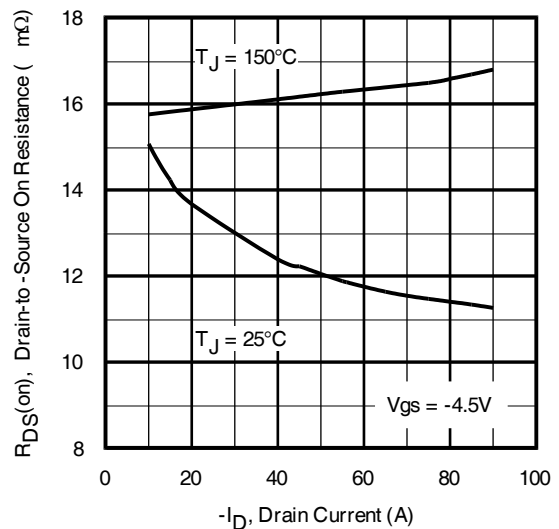

Fig 6. Typical On-Resistance Vs Drain Current

Pre-Irradiation

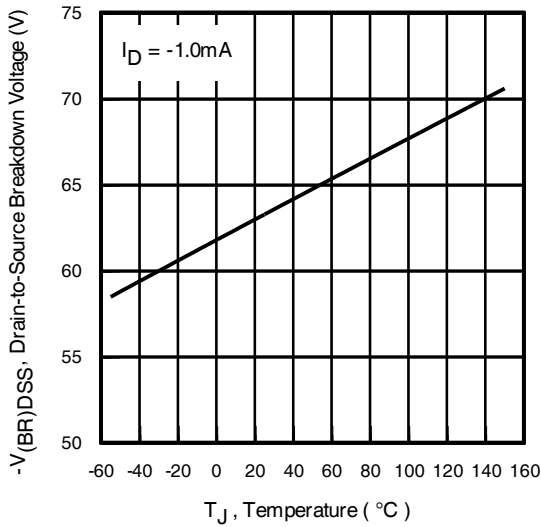

Fig 7. Typical Drain-to-Source Breakdown Voltage Vs Temperature

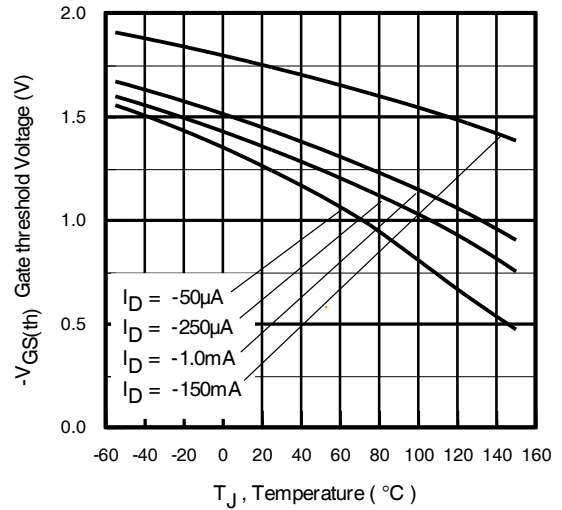

Fig 8. Typical Threshold Voltage Vs Temperature

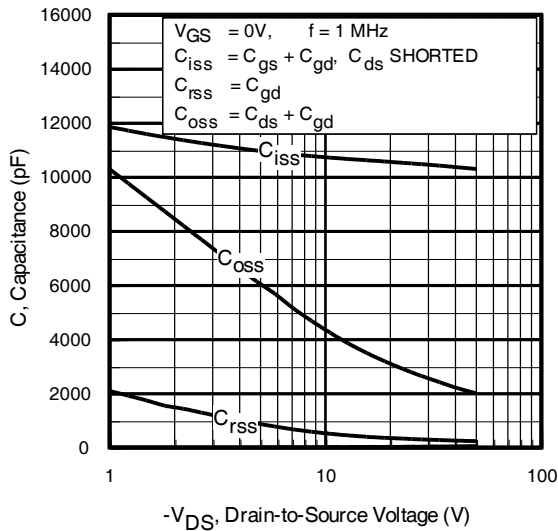

Fig 9. Typical Capacitance Vs. Drain-to-Source Voltage

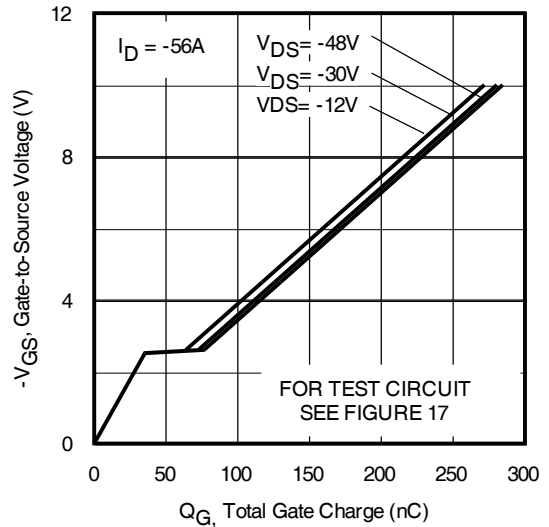

Fig 10. Typical Gate Charge Vs. Gate-to-Source Voltage

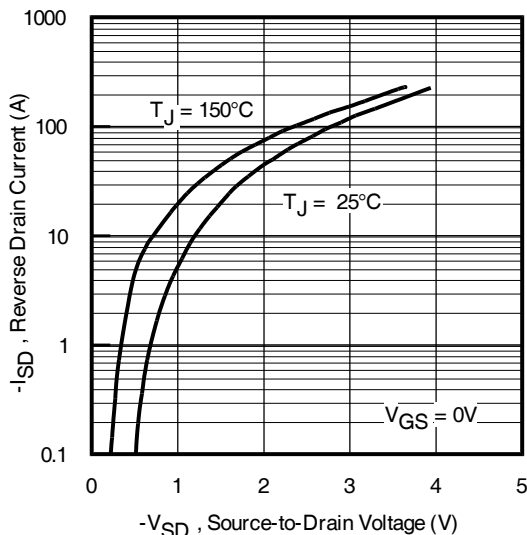

Fig 11. Typical Source-Drain Diode Forward Voltage

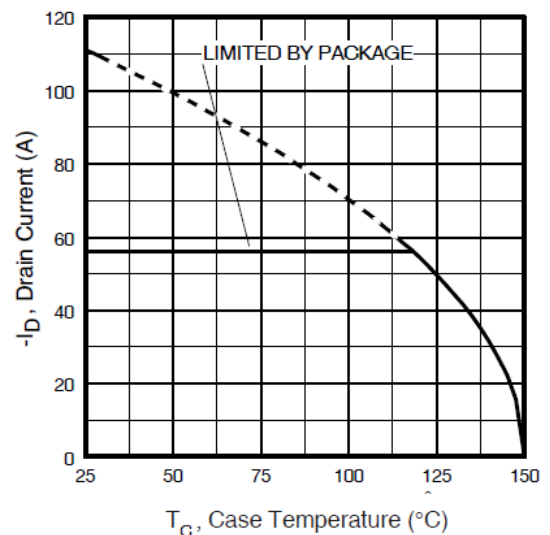

Fig 12. Maximum Drain Current Vs. Case Temperature

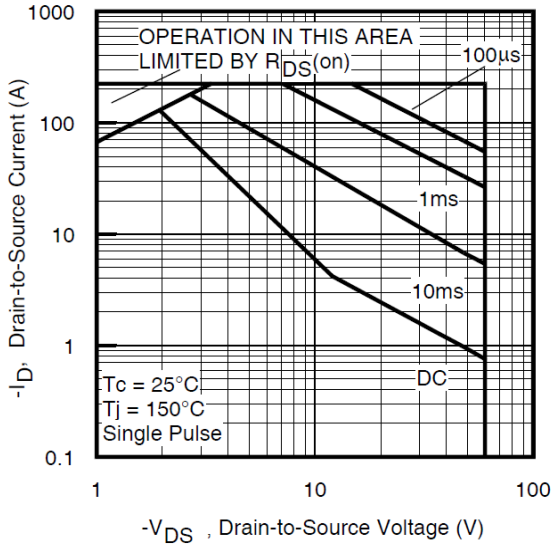

Fig 13. Maximum Safe Operating Area

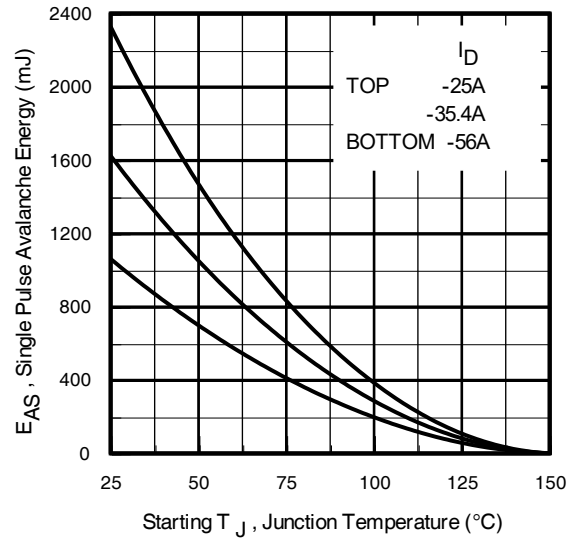

Fig 14. Maximum Avalanche Energy Vs. Drain Current

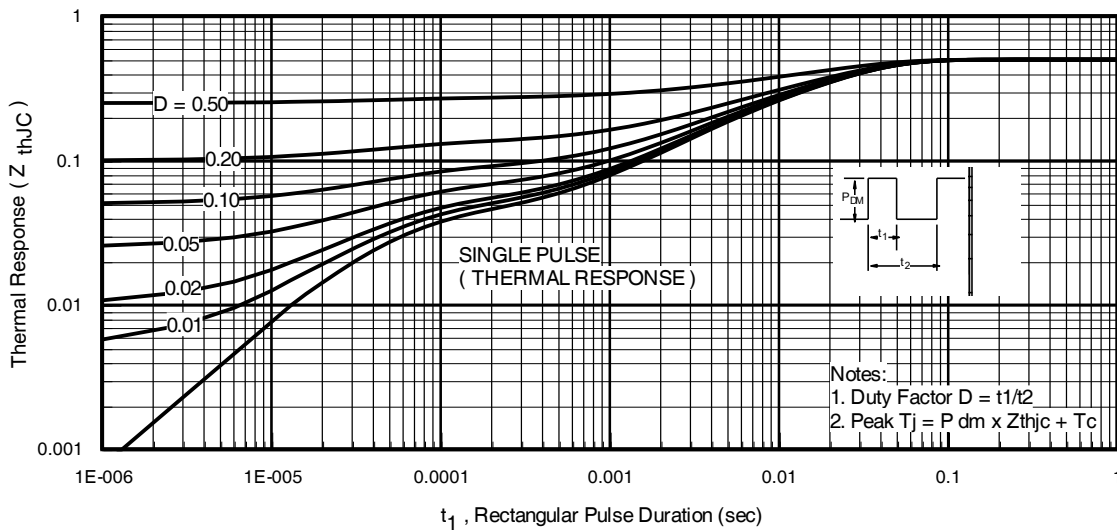

Fig 15. Maximum Effective Transient Thermal Impedance, Junction-to-Case

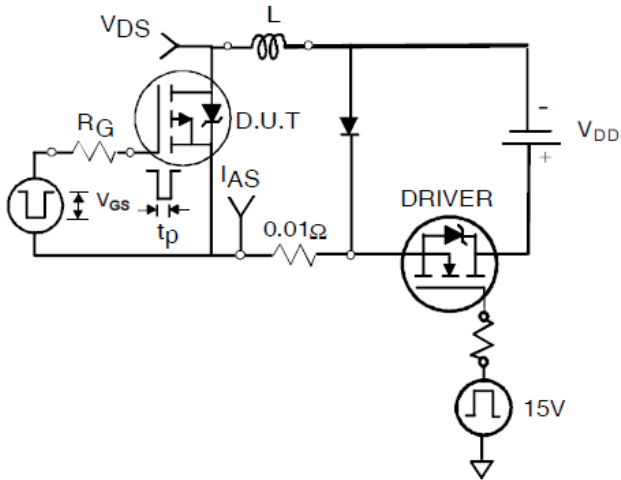

Fig 16a. Unclamped Inductive Test Circuit

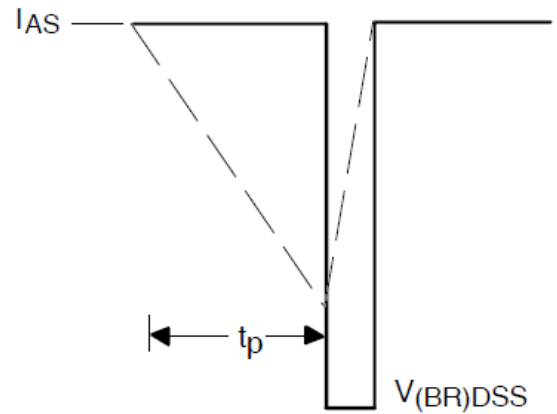

Fig 16b. Unclamped Inductive Wave-

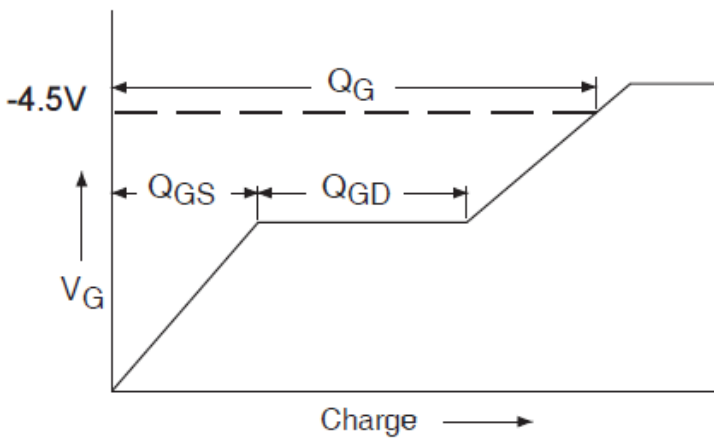

Fig 17a. Gate Charge Waveform

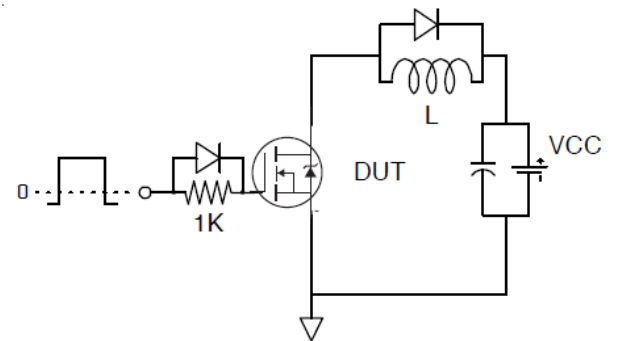

Fig 17b. Gate Charge Test Circuit

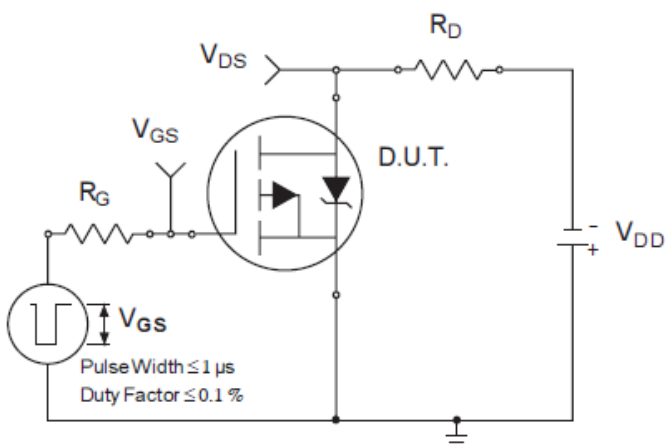

Fig 18a. Switching Time Test Circuit

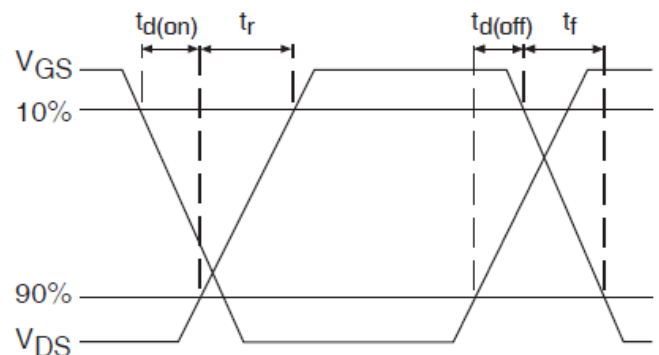
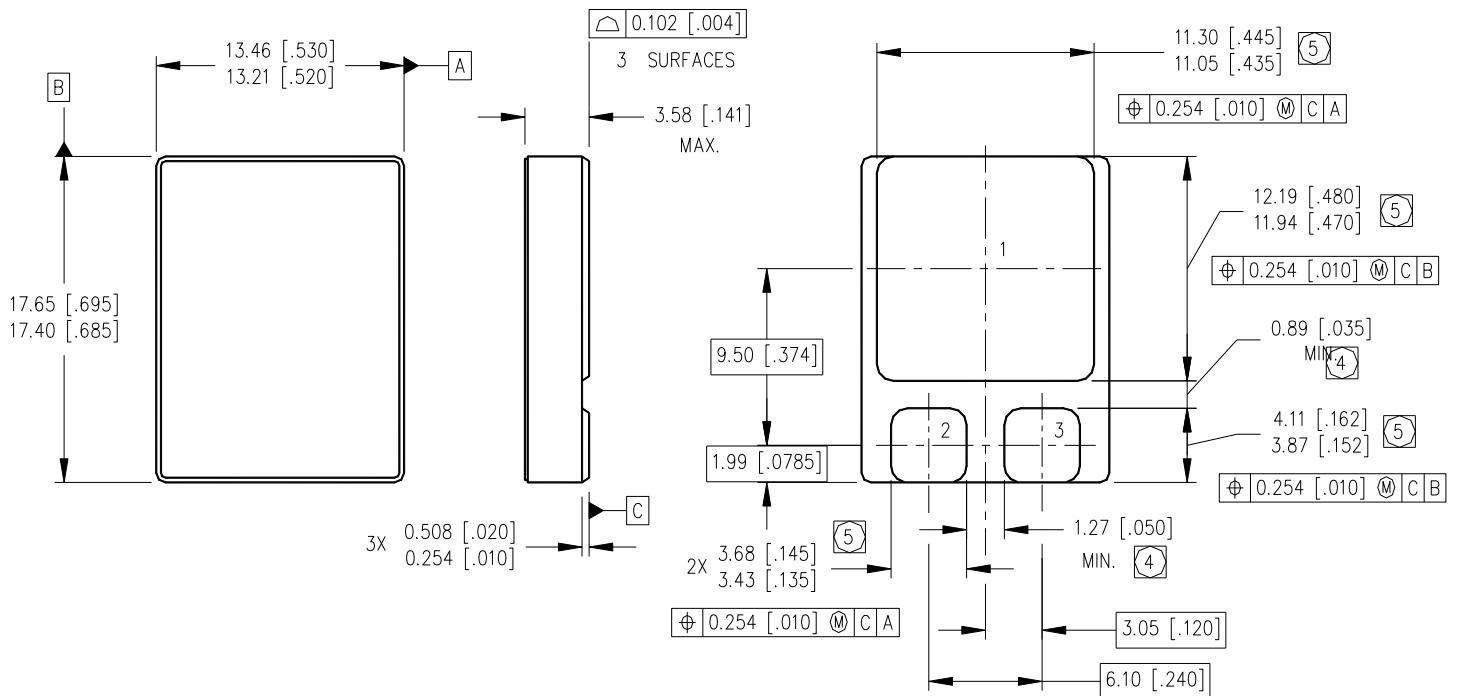

Fig 18b. Switching Time Waveforms

Case Outline and Dimensions - SMD-2



NOTES:

1. DIMENSIONING & TOLERANCING PER ASME Y14.5M-1994.
2. CONTROLLING DIMENSION: INCH.
3. DIMENSIONS ARE SHOWN IN MILLIMETERS [INCHES].



- 4 DIMENSION INCLUDES METALLIZATION FLASH.
- 5 DIMENSION DOES NOT INCLUDE METALLIZATION FLASH.

PAD ASSIGNMENTS

MOSFET

- 1 = DRAIN
- 2 = GATE
- 3 = SOURCE

IMPORTANT NOTICE

The information given in this document shall be in no event regarded as guarantee of conditions or characteristic. The data contained herein is a characterization of the component based on internal standards and is intended to demonstrate and provide guidance for typical part performance. It will require further evaluation, qualification and analysis to determine suitability in the application environment to confirm compliance to your system requirements.

With respect to any example hints or any typical values stated herein and/or any information regarding the application of the product, Infineon Technologies hereby disclaims any and all warranties and liabilities of any kind including without limitation warranties on non- infringement of intellectual property rights and any third party.

In addition, any information given in this document is subject to customer's compliance with its obligations stated in this document and any applicable legal requirements, norms and standards concerning customer's product and any use of the product of Infineon Technologies in customer's applications.

The data contained in this document is exclusively intended for technically trained staff. It is the responsibility of any customer's technical departments to evaluate the suitability of the product for the intended applications and the completeness of the product information given in this document with respect to applications.

For further information on the product, technology, delivery terms and conditions and prices, please contact your local sales representative or go to (www.infineon.com/hirel).

WARNING

Due to technical requirements products may contain dangerous substances. For information on the types in question, please contact your nearest Infineon Technologies office.