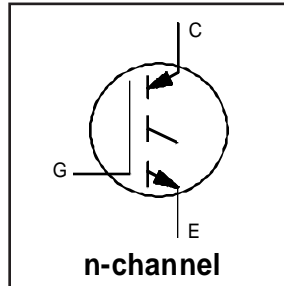


**Features**

- Switching-loss rating includes all "tail" losses
- Optimized for medium operating frequency (1 to 10kHz) See Fig. 1 for Current vs. Frequency curve



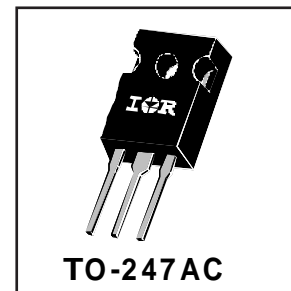
$V_{CES} = 600V$

$V_{CE(sat)} \leq 2.0V$

@  $V_{GE} = 15V, I_C = 27A$

**Description**

Insulated Gate Bipolar Transistors (IGBTs) from International Rectifier have higher usable current densities than comparable bipolar transistors, while at the same time having simpler gate-drive requirements of the familiar power MOSFET. They provide substantial benefits to a host of high-voltage, high-current applications.



**Absolute Maximum Ratings**

	Parameter	Max.	Units
$V_{CES}$	Collector-to-Emitter Voltage	600	V
$I_C @ T_C = 25^\circ C$	Continuous Collector Current	49	A
$I_C @ T_C = 100^\circ C$	Continuous Collector Current	27	
$I_{CM}$	Pulsed Collector Current ①	200	
$I_{LM}$	Clamped Inductive Load Current ②	200	
$V_{GE}$	Gate-to-Emitter Voltage	$\pm 20$	V
$E_{ARV}$	Reverse Voltage Avalanche Energy ③	15	mJ
$P_D @ T_C = 25^\circ C$	Maximum Power Dissipation	160	W
$P_D @ T_C = 100^\circ C$	Maximum Power Dissipation	65	
$T_J$	Operating Junction and Storage Temperature Range	-55 to +150	$^\circ C$
$T_{STG}$			
	Mounting torque, 6-32 or M3 screw.	10 lbf•in (1.1N•m)	

**Thermal Resistance**

	Parameter	Min.	Typ.	Max.	Units
$R_{\theta JC}$	Junction-to-Case	-----	-----	0.77	$^\circ C/W$
$R_{\theta CS}$	Case-to-Sink, flat, greased surface	-----	0.24	-----	
$R_{\theta JA}$	Junction-to-Ambient, typical socket mount	-----	-----	40	
Wt	Weight	-----	6 (0.21)	-----	g (oz)

## Electrical Characteristics @ $T_J = 25^\circ\text{C}$ (unless otherwise specified)

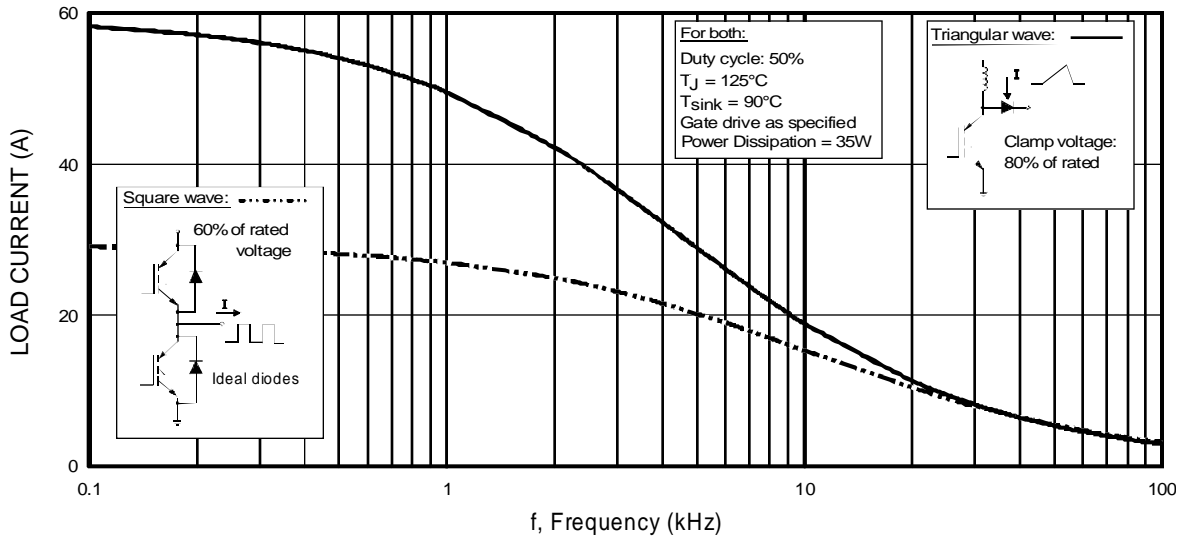
	Parameter	Min.	Typ.	Max.	Units	Conditions
$V_{(BR)CES}$	Collector-to-Emitter Breakdown Voltage	600	----	----	V	$V_{GE} = 0V, I_C = 250\mu A$
$V_{(BR)ECS}$	Emitter-to-Collector Breakdown Voltage ②	20	----	----	V	$V_{GE} = 0V, I_C = 1.0A$
$\Delta V_{(BR)CES}/\Delta T_J$	Temperature Coeff. of Breakdown Voltage	----	0.70	----	$V/^\circ\text{C}$	$V_{GE} = 0V, I_C = 1.0mA$
$V_{CE(on)}$	Collector-to-Emitter Saturation Voltage	----	1.7	2.0	V	$I_C = 27A$ $V_{GE} = 15V$
		----	2.2	----		$I_C = 49A$ See Fig. 2, 5
		----	1.9	----		$I_C = 27A, T_J = 150^\circ\text{C}$
$V_{GE(th)}$	Gate Threshold Voltage	3.0	----	5.5		$V_{CE} = V_{GE}, I_C = 250\mu A$
$\Delta V_{GE(th)}/\Delta T_J$	Temperature Coeff. of Threshold Voltage	----	-12	----	$mV/^\circ\text{C}$	$V_{CE} = V_{GE}, I_C = 250\mu A$
$g_{fe}$	Forward Transconductance ⑤	9.2	12	----	S	$V_{CE} = 100V, I_C = 27A$
$I_{CES}$	Zero Gate Voltage Collector Current	----	----	250	$\mu A$	$V_{GE} = 0V, V_{CE} = 600V$
		----	----	1000		$V_{GE} = 0V, V_{CE} = 600V, T_J = 150^\circ\text{C}$
$I_{GES}$	Gate-to-Emitter Leakage Current	----	----	$\pm 100$	nA	$V_{GE} = \pm 20V$

## Switching Characteristics @ $T_J = 25^\circ\text{C}$ (unless otherwise specified)

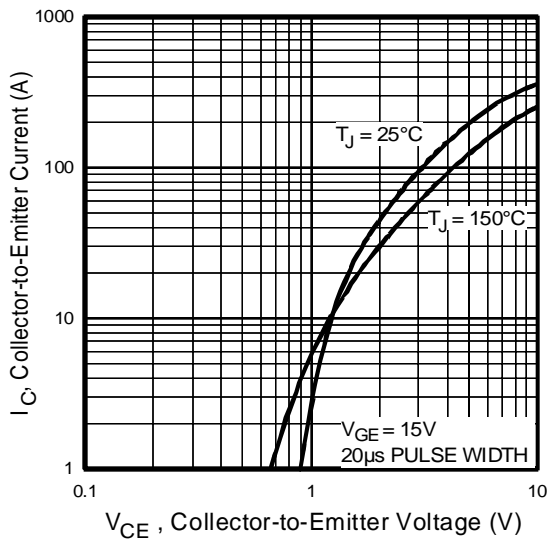
	Parameter	Min.	Typ.	Max.	Units	Conditions
$Q_g$	Total Gate Charge (turn-on)	----	59	80	nC	$I_C = 27A$
$Q_{ge}$	Gate - Emitter Charge (turn-on)	----	8.6	10		$V_{CC} = 400V$ See Fig. 8
$Q_{gc}$	Gate - Collector Charge (turn-on)	----	25	42		$V_{GE} = 15V$
$t_{d(on)}$	Turn-On Delay Time	----	25	----	ns	$T_J = 25^\circ\text{C}$
$t_r$	Rise Time	----	37	----		$I_C = 27A, V_{CC} = 480V$
$t_{d(off)}$	Turn-Off Delay Time	----	240	410		$V_{GE} = 15V, R_G = 10\Omega$
$t_f$	Fall Time	----	230	420	mJ	Energy losses include "tail"
$E_{on}$	Turn-On Switching Loss	----	0.65	----		See Fig. 9, 10, 11, 14
$E_{off}$	Turn-Off Switching Loss	----	3.0	----		
$E_{ts}$	Total Switching Loss	----	3.65	6.0		
$t_{d(on)}$	Turn-On Delay Time	----	28	----	ns	$T_J = 150^\circ\text{C}$ ,
$t_r$	Rise Time	----	37	----		$I_C = 27A, V_{CC} = 480V$
$t_{d(off)}$	Turn-Off Delay Time	----	380	----		$V_{GE} = 15V, R_G = 10\Omega$
$t_f$	Fall Time	----	460	----	mJ	Energy losses include "tail"
$E_{ts}$	Total Switching Loss	----	6.0	----		See Fig. 10, 14
$L_E$	Internal Emitter Inductance	----	13	----		nH
$C_{ies}$	Input Capacitance	----	1500	----	pF	$V_{GE} = 0V$
$C_{oes}$	Output Capacitance	----	190	----		$V_{CC} = 30V$ See Fig. 7
$C_{res}$	Reverse Transfer Capacitance	----	20	----		$f = 1.0MHz$

### Notes:

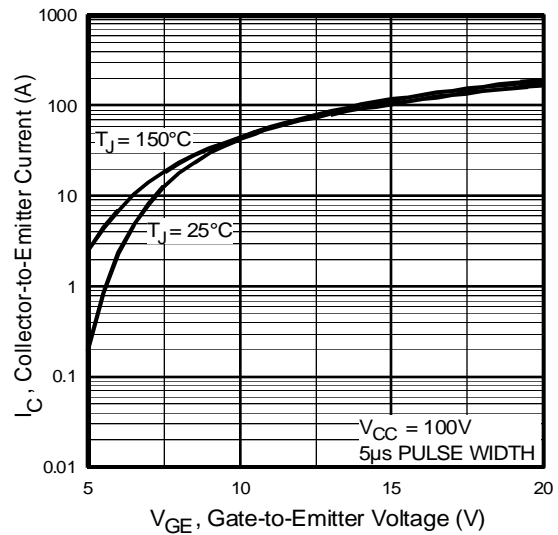
- ① Repetitive rating;  $V_{GE}=20V$ , pulse width limited by max. junction temperature. ( See fig. 13b )
- ②  $V_{CC}=80\%(V_{CES}), V_{GE}=20V, L=10\mu H, R_G=10\Omega$ , ( See fig. 13a )
- ③ Repetitive rating; pulse width limited by maximum junction temperature.
- ④ Pulse width  $\leq 80\mu s$ ; duty factor  $\leq 0.1\%$ .
- ⑤ Pulse width  $5.0\mu s$ , single shot.



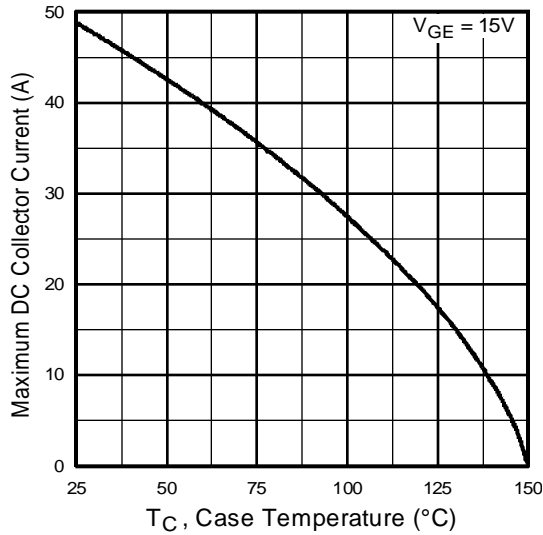
**Fig. 1 - Typical Load Current vs. Frequency**  
 (For square wave,  $I = I_{\text{RMS}}$  of fundamental; for triangular wave,  $I = I_{\text{PK}}$ )



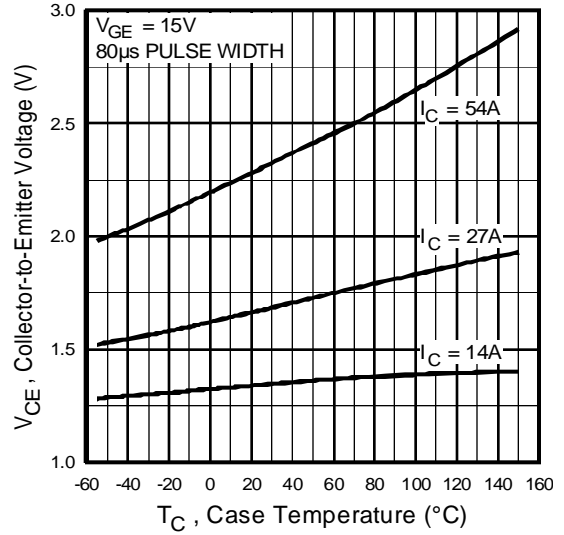
**Fig. 2 - Typical Output Characteristics**



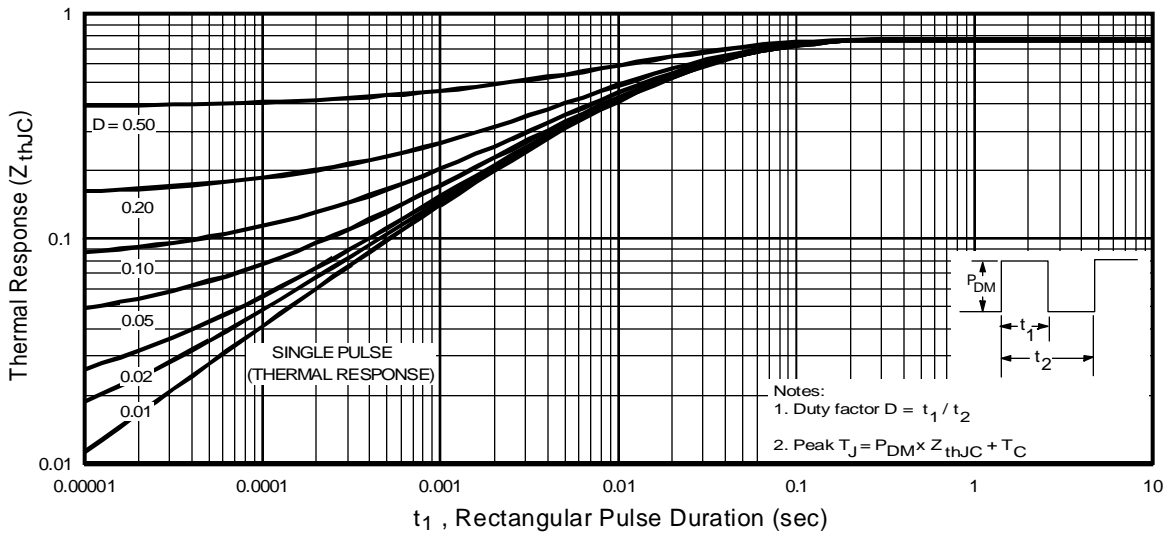
**Fig. 3 - Typical Transfer Characteristics**



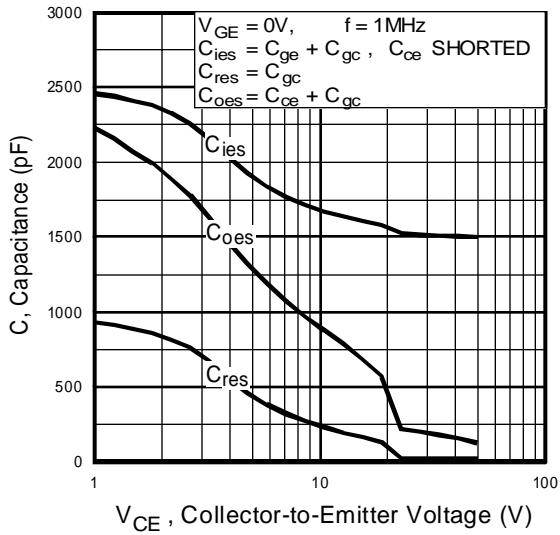
**Fig. 4** - Maximum Collector Current vs. Case Temperature



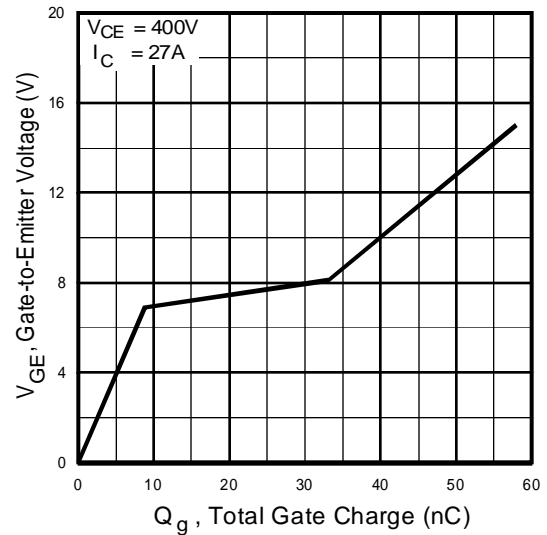
**Fig. 5** - Collector-to-Emitter Voltage vs. Case Temperature



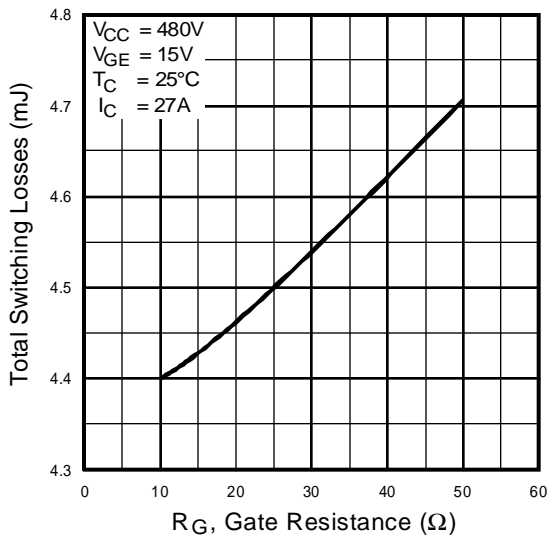
**Fig. 6** - Maximum Effective Transient Thermal Impedance, Junction-to-Case



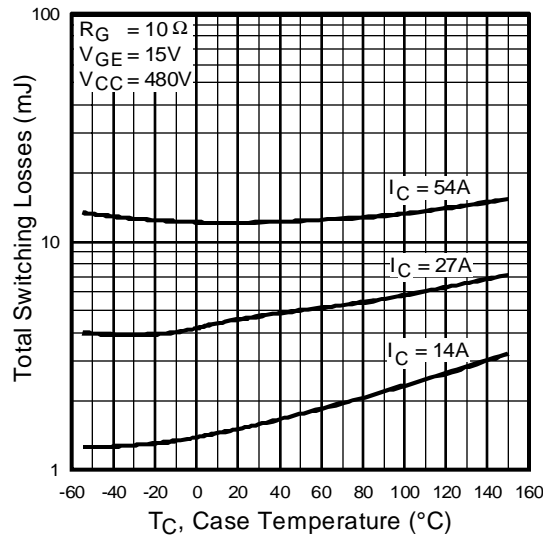
**Fig. 7** - Typical Capacitance vs. Collector-to-Emitter Voltage



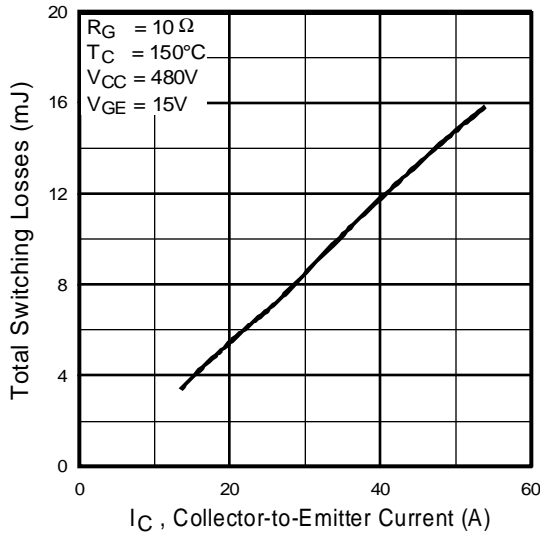
**Fig. 8** - Typical Gate Charge vs. Gate-to-Emitter Voltage



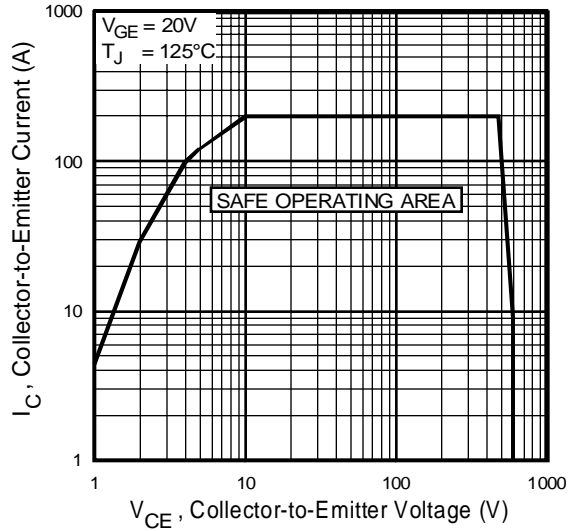
**Fig. 9** - Typical Switching Losses vs. Gate Resistance



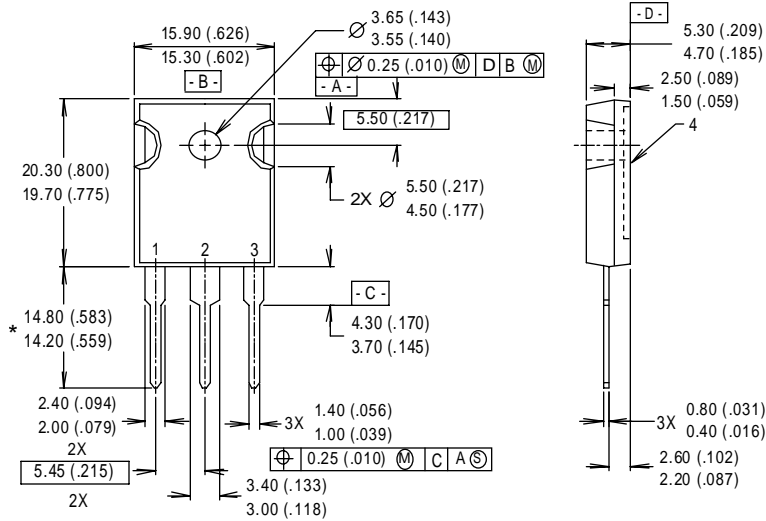
**Fig. 10** - Typical Switching Losses vs. Case Temperature



**Fig. 11 - Typical Switching Losses vs. Collector-to-Emitter Current**



**Fig. 12 - Turn-Off SOA**

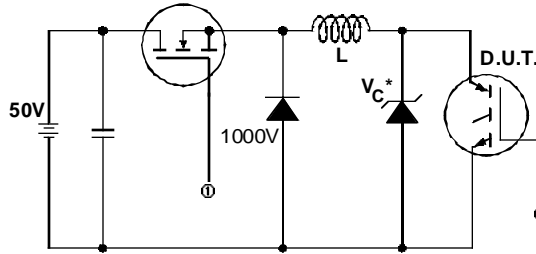


**NOTES:**  
 1 DIMENSIONS & TOLERANCING PER ANSI Y14.5M, 1982.  
 2 CONTROLLING DIMENSION : INCH.  
 3 DIMENSIONS ARE SHOWN MILLIMETERS (INCHES).  
 4 CONFORMS TO JEDEC OUTLINE TO-247AC.

**LEAD ASSIGNMENTS**  
 1 - GATE  
 2 - COLLECTOR  
 3 - EMITTER  
 4 - COLLECTOR

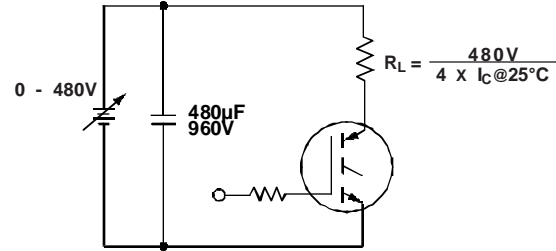
\* LONGER LEADED (20mm) VERSION AVAILABLE (TO-247AD) TO ORDER ADD "-E" SUFFIX TO PART NUMBER

**CONFORMS TO JEDEC OUTLINE TO-247AC (TO-3P)**  
 Dimensions in Millimeters and (Inches)

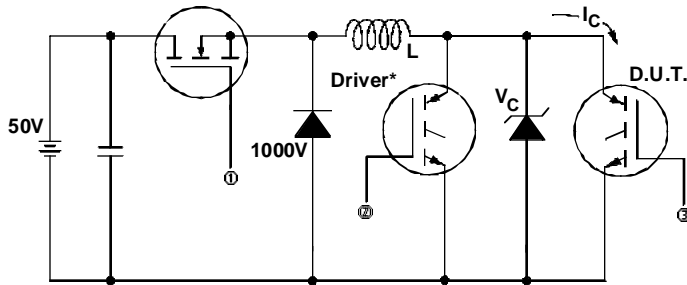


\* Driver same type as D.U.T.;  $V_c = 80\%$  of  $V_{ce(max)}$   
 \* Note: Due to the 50V power supply, pulse width and inductor will increase to obtain rated  $I_d$ .

**Fig. 13a** - Clamped Inductive Load Test Circuit

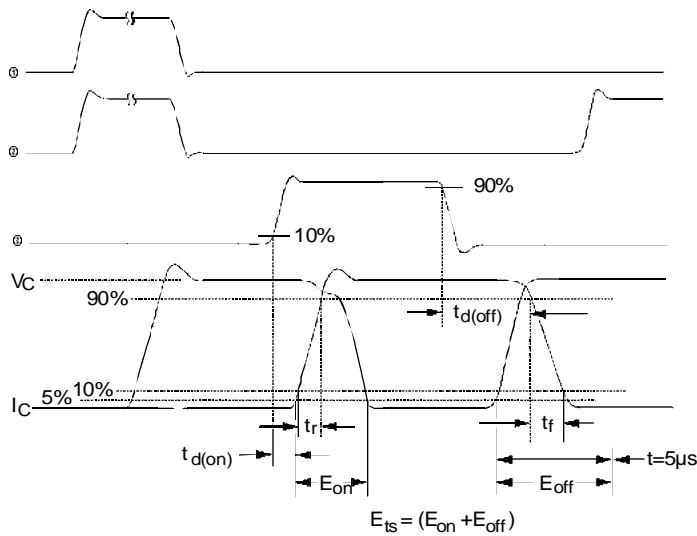


**Fig. 13b** - Pulsed Collector Current Test Circuit



**Fig. 14a** - Switching Loss Test Circuit

\* Driver same type as D.U.T.,  $V_C = 480V$



**Fig. 14b** - Switching Loss Waveforms

Note: For the most current drawings please refer to the IR website at:  
<http://www.irf.com/package/>