

**INSULATED GATE BIPOLAR TRANSISTOR  
WITH ULTRAFAST SOFT RECOVERY DIODE**

Fast CoPack IGBT

**Features**

- Switching-loss rating includes all "tail" losses
- HEXFRED™ soft ultrafast diodes
- Optimized for medium operating frequency (1 to 10kHz) See Fig. 1 for Current vs. Frequency curve

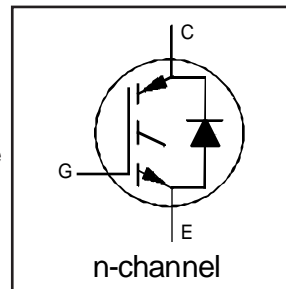

$V_{CES} = 600V$

$V_{CE(sat)} \leq 2.1V$

@  $V_{GE} = 15V, I_C = 17A$

**Description**

Co-packaged IGBTs are a natural extension of International Rectifier's well known IGBT line. They provide the convenience of an IGBT and an ultrafast recovery diode in one package, resulting in substantial benefits to a host of high-voltage, high-current, motor control, UPS and power supply applications.

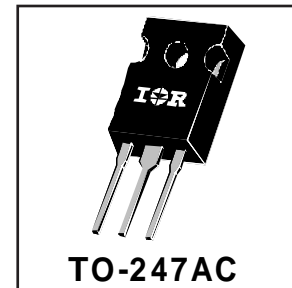

**Absolute Maximum Ratings**

	Parameter	Max.	Units
$V_{CES}$	Collector-to-Emitter Voltage	600	V
$I_C @ T_C = 25^\circ C$	Continuous Collector Current	31	A
$I_C @ T_C = 100^\circ C$	Continuous Collector Current	17	
$I_{CM}$	Pulsed Collector Current ①	120	
$I_{LM}$	Clamped Inductive Load Current ②	120	
$I_F @ T_C = 100^\circ C$	Diode Continuous Forward Current	12	
$I_{FM}$	Diode Maximum Forward Current	120	
$V_{GE}$	Gate-to-Emitter Voltage	$\pm 20$	V
$P_D @ T_C = 25^\circ C$	Maximum Power Dissipation	100	W
$P_D @ T_C = 100^\circ C$	Maximum Power Dissipation	42	
$T_J$	Operating Junction and Storage Temperature Range	-55 to +150	°C
$T_{STG}$			
	Mounting Torque, 6-32 or M3 Screw.	10 lbf•in (1.1 N•m)	

**Thermal Resistance**

	Parameter	Min.	Typ.	Max.	Units
$R_{\theta JC}$	Junction-to-Case - IGBT	-----	-----	1.2	°C/W
$R_{\theta JC}$	Junction-to-Case - Diode	-----	-----	2.5	
$R_{\theta CS}$	Case-to-Sink, flat, greased surface	-----	0.24	-----	
$R_{\theta JA}$	Junction-to-Ambient, typical socket mount	-----	-----	40	
Wt	Weight	-----	6 (0.21)	-----	g (oz)

# IRGPC30FD2



## Electrical Characteristics @ T<sub>J</sub> = 25°C (unless otherwise specified)

	Parameter	Min.	Typ.	Max.	Units	Conditions
V <sub>(BR)CES</sub>	Collector-to-Emitter Breakdown Voltage <sup>③</sup>	600	----	----	V	V <sub>GE</sub> = 0V, I <sub>C</sub> = 250μA
ΔV <sub>(BR)CES</sub> /ΔT <sub>J</sub>	Temperature Coeff. of Breakdown Voltage	----	0.69	----	V/°C	V <sub>GE</sub> = 0V, I <sub>C</sub> = 1.0mA
V <sub>CE(on)</sub>	Collector-to-Emitter Saturation Voltage	----	1.8	2.1	V	I <sub>C</sub> = 17A, V <sub>GE</sub> = 15V
		----	2.4	----		I <sub>C</sub> = 31A, V <sub>GE</sub> = 15V
		----	2.2	----		I <sub>C</sub> = 17A, T <sub>J</sub> = 150°C
V <sub>GE(th)</sub>	Gate Threshold Voltage	3.0	----	5.5		V <sub>CE</sub> = V <sub>GE</sub> , I <sub>C</sub> = 250μA
ΔV <sub>GE(th)</sub> /ΔT <sub>J</sub>	Temperature Coeff. of Threshold Voltage	----	-11	----	mV/°C	V <sub>CE</sub> = V <sub>GE</sub> , I <sub>C</sub> = 250μA
g <sub>fe</sub>	Forward Transconductance <sup>④</sup>	6.1	10	----	S	V <sub>CE</sub> = 100V, I <sub>C</sub> = 17A
I <sub>CES</sub>	Zero Gate Voltage Collector Current	----	----	250	μA	V <sub>GE</sub> = 0V, V <sub>CE</sub> = 600V
		----	----	2500		V <sub>GE</sub> = 0V, V <sub>CE</sub> = 600V, T <sub>J</sub> = 150°C
V <sub>FM</sub>	Diode Forward Voltage Drop	----	1.4	1.7	V	I <sub>C</sub> = 12A, V <sub>GE</sub> = 15V
		----	1.3	1.6		I <sub>C</sub> = 12A, T <sub>J</sub> = 150°C
I <sub>GES</sub>	Gate-to-Emitter Leakage Current	----	----	±100	nA	V <sub>GE</sub> = ±20V

## Switching Characteristics @ T<sub>J</sub> = 25°C (unless otherwise specified)

	Parameter	Min.	Typ.	Max.	Units	Conditions	
Q <sub>g</sub>	Total Gate Charge (turn-on)	----	27	30	nC	I <sub>C</sub> = 17A	
Q <sub>ge</sub>	Gate - Emitter Charge (turn-on)	----	4.1	5.9		V <sub>CC</sub> = 400V	
Q <sub>gc</sub>	Gate - Collector Charge (turn-on)	----	12	15		See Fig. 8	
t <sub>d(on)</sub>	Turn-On Delay Time	----	72	----	ns	T <sub>J</sub> = 25°C	
t <sub>r</sub>	Rise Time	----	75	----		I <sub>C</sub> = 17A, V <sub>CC</sub> = 480V	
t <sub>d(off)</sub>	Turn-Off Delay Time	----	300	450		V <sub>GE</sub> = 15V, R <sub>G</sub> = 23Ω	
t <sub>f</sub>	Fall Time	----	220	350	mJ	Energy losses include "tail" and diode reverse recovery.	
E <sub>on</sub>	Turn-On Switching Loss	----	0.9	----		See Fig. 9, 10, 11, 18	
E <sub>off</sub>	Turn-Off Switching Loss	----	2.1	----			
E <sub>ts</sub>	Total Switching Loss	----	3.0	4.6	mJ		
t <sub>d(on)</sub>	Turn-On Delay Time	----	70	----		ns	T <sub>J</sub> = 150°C, V <sub>CC</sub> = 480V
t <sub>r</sub>	Rise Time	----	75	----			I <sub>C</sub> = 17A, V <sub>CC</sub> = 480V
t <sub>d(off)</sub>	Turn-Off Delay Time	----	420	----	V <sub>GE</sub> = 15V, R <sub>G</sub> = 23Ω		
t <sub>f</sub>	Fall Time	----	480	----	mJ	Energy losses include "tail" and diode reverse recovery.	
E <sub>ts</sub>	Total Switching Loss	----	4.7	----			
L <sub>E</sub>	Internal Emitter Inductance	----	13	----		nH	Measured 5mm from package
C <sub>ies</sub>	Input Capacitance	----	670	----	pF	V <sub>GE</sub> = 0V	
C <sub>oes</sub>	Output Capacitance	----	100	----		V <sub>CC</sub> = 30V	
C <sub>res</sub>	Reverse Transfer Capacitance	----	10	----		f = 1.0MHz	
t <sub>rr</sub>	Diode Reverse Recovery Time	----	42	60	ns	T <sub>J</sub> = 25°C, I <sub>F</sub> = 12A	
		----	80	120		T <sub>J</sub> = 125°C	
I <sub>rr</sub>	Diode Peak Reverse Recovery Current	----	3.5	6.0	A	T <sub>J</sub> = 25°C, V <sub>R</sub> = 200V	
		----	5.6	10		T <sub>J</sub> = 125°C	
Q <sub>rr</sub>	Diode Reverse Recovery Charge	----	80	180	nC	T <sub>J</sub> = 25°C, di/dt = 200A/μs	
		----	220	600		T <sub>J</sub> = 125°C	
μs	d <sub>(rec)</sub> /dt Diode Peak Rate of Fall of Recovery	----	17	----	A/μs	180	
----		See Fig. 17	----	During t <sub>b</sub>		120	

### Notes:

- ① Repetitive rating; V<sub>GE</sub>=20V, pulse width limited by max. junction temperature. ( See fig. 20 )
- ② V<sub>CC</sub>=80%(V<sub>CES</sub>), V<sub>GE</sub>=20V, L=10μH, R<sub>G</sub> = 23Ω, ( See fig. 19 )
- ③ Pulse width ≤ 80μs; duty factor ≤ 0.1%.
- ④ Pulse width 5.0μs, single shot.

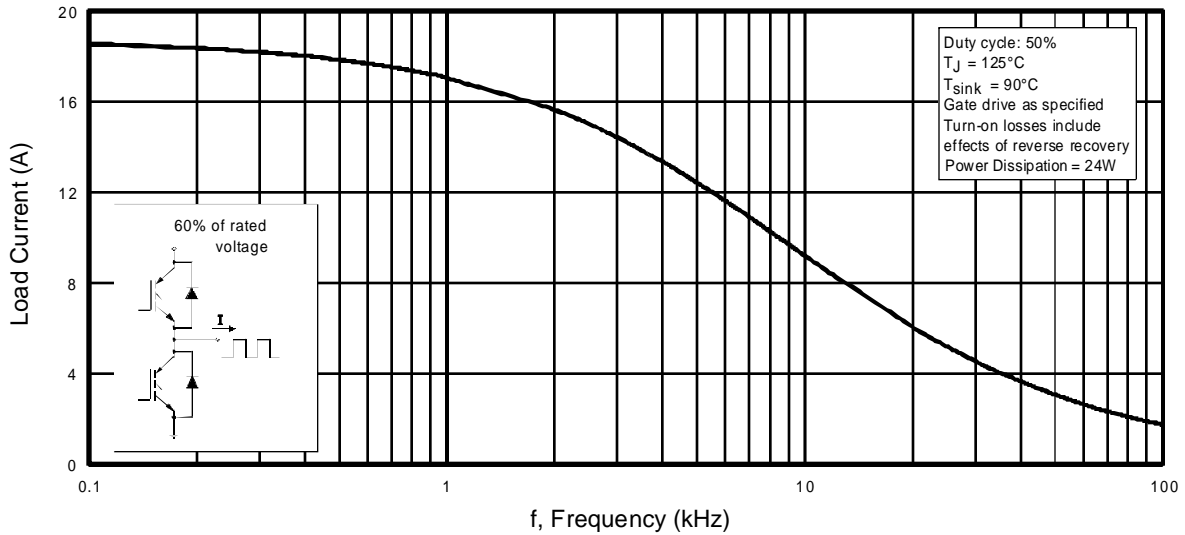

**Fig. 1 - Typical Load Current vs. Frequency**  
(Load Current =  $I_{RMS}$  of fundamental)

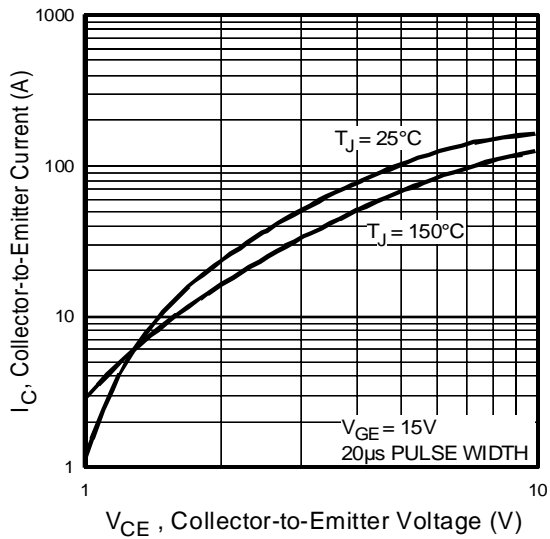

**Fig. 2 - Typical Output Characteristics**

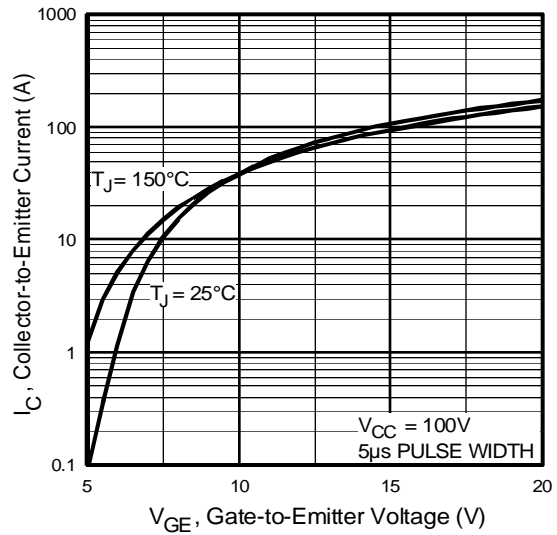

**Fig. 3 - Typical Transfer Characteristics**

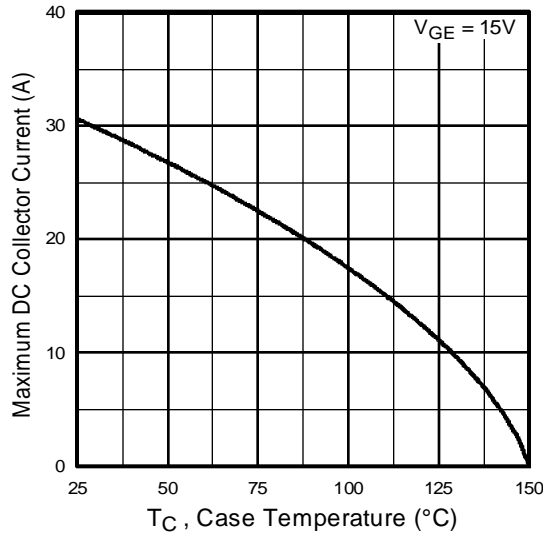

**Fig. 4** - Maximum Collector Current vs. Case Temperature

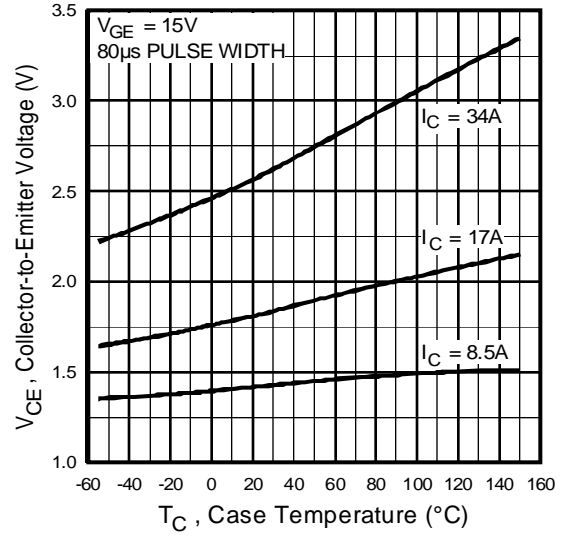

**Fig. 5** - Collector-to-Emitter Voltage vs. Case Temperature

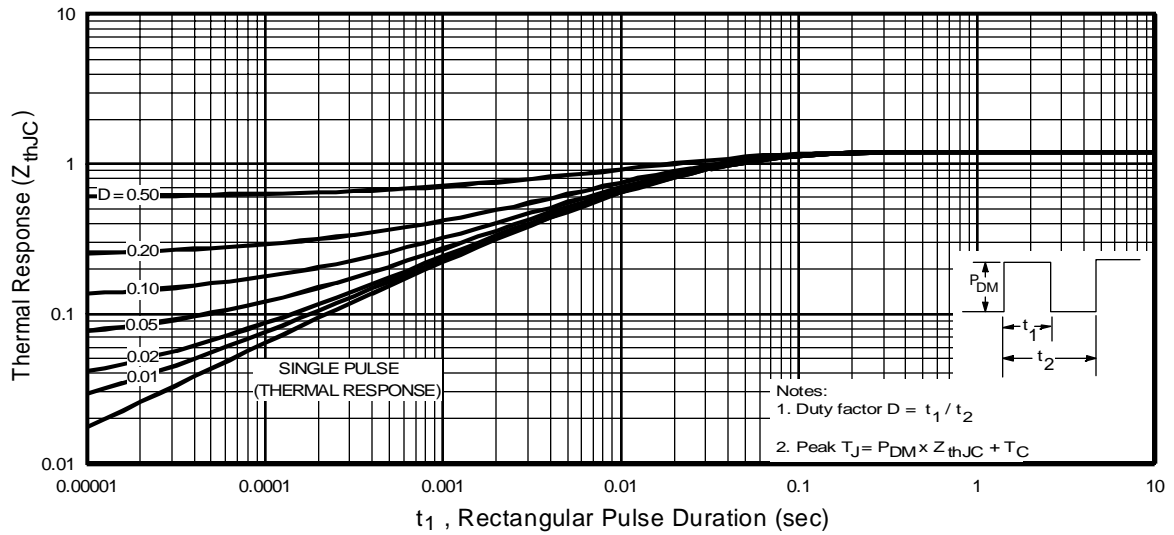

**Fig. 6** - Maximum IGBT Effective Transient Thermal Impedance, Junction-to-Case

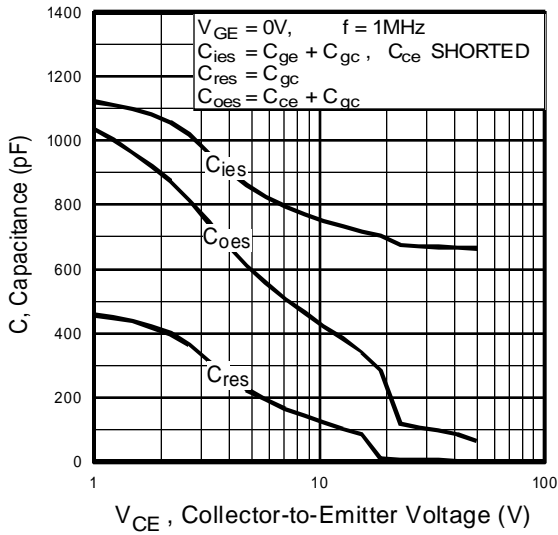

**Fig. 7** - Typical Capacitance vs. Collector-to-Emitter Voltage

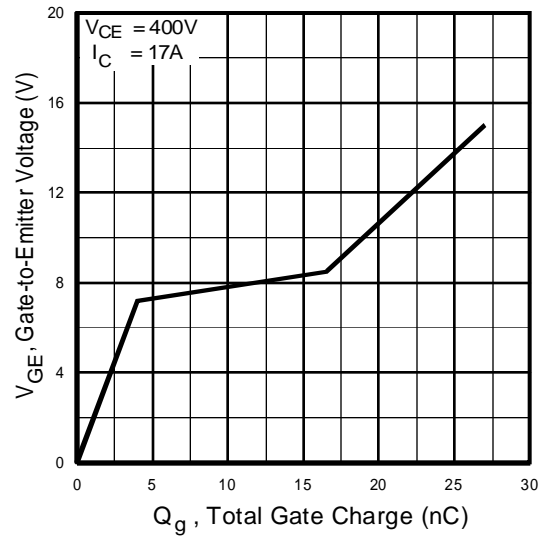

**Fig. 8** - Typical Gate Charge vs. Gate-to-Emitter Voltage

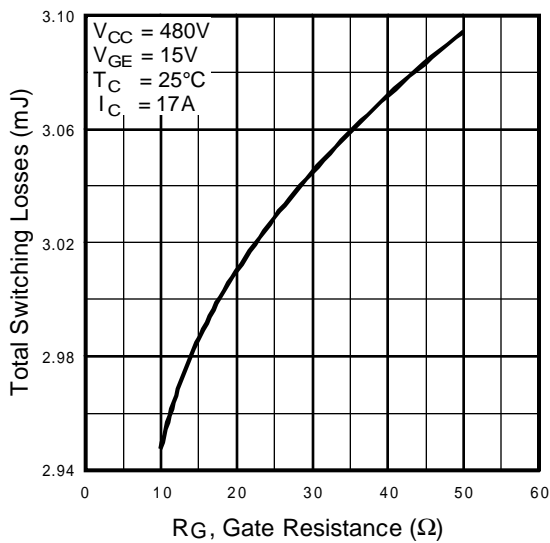

**Fig. 9** - Typical Switching Losses vs. Gate Resistance

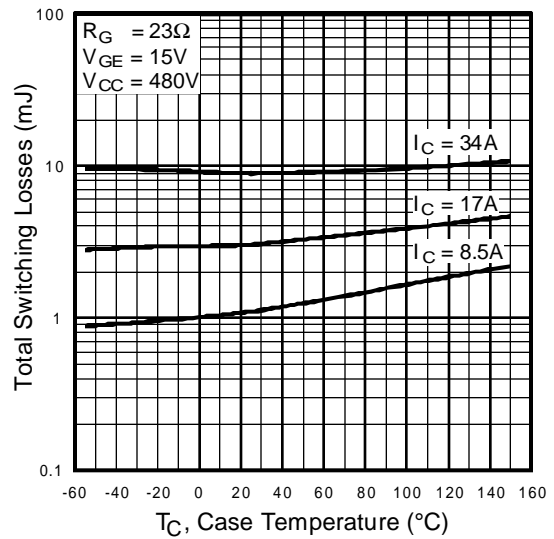

**Fig. 10** - Typical Switching Losses vs. Case Temperature

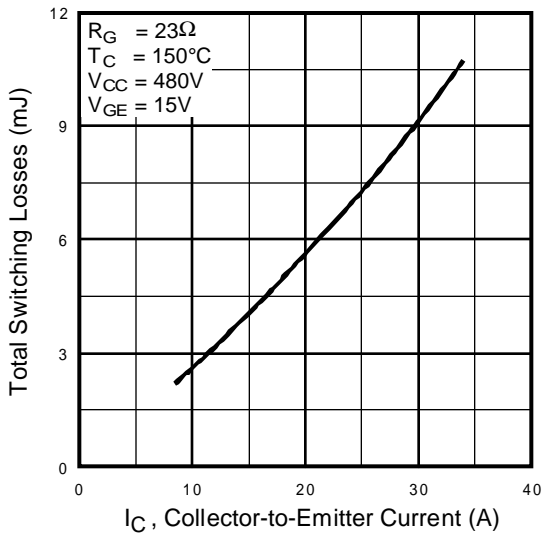

**Fig. 11** - Typical Switching Losses vs. Collector-to-Emitter Current

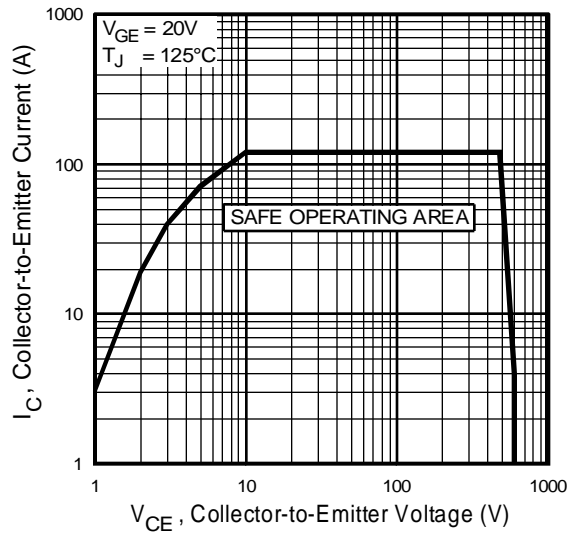

**Fig. 12** - Turn-Off SOA

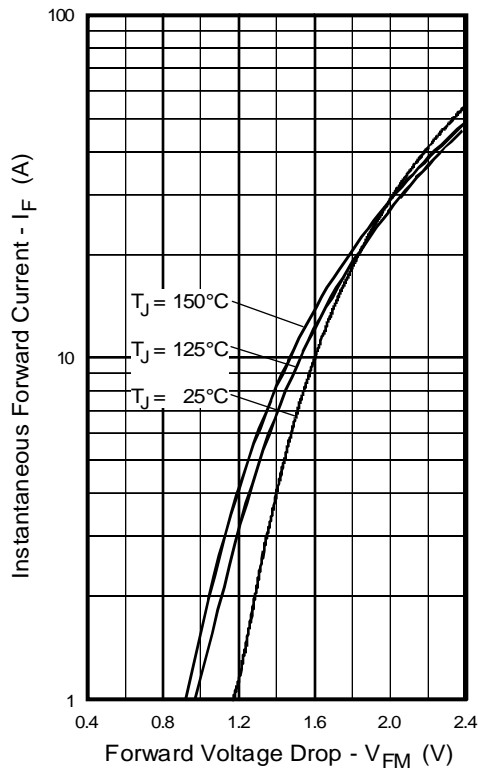

**Fig. 13** - Maximum Forward Voltage Drop vs. Instantaneous Forward Current

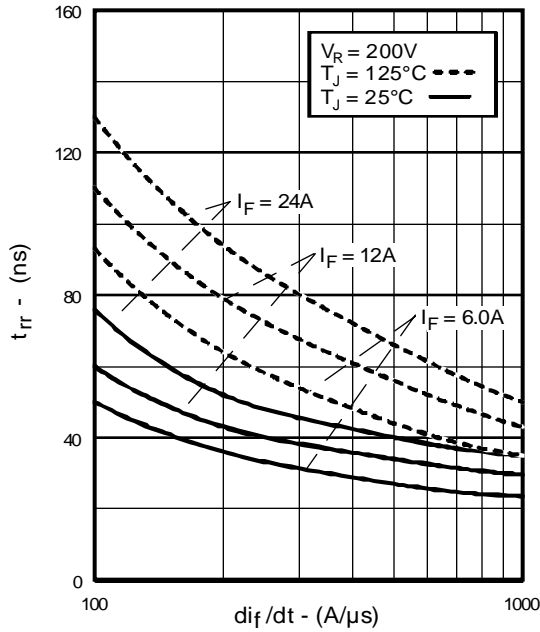

**Fig. 14** - Typical Reverse Recovery vs.  $di_f/dt$

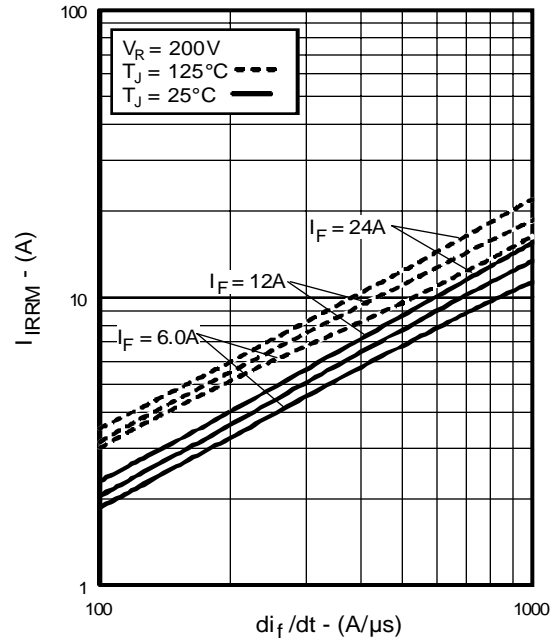

**Fig. 15** - Typical Recovery Current vs.  $di_f/dt$

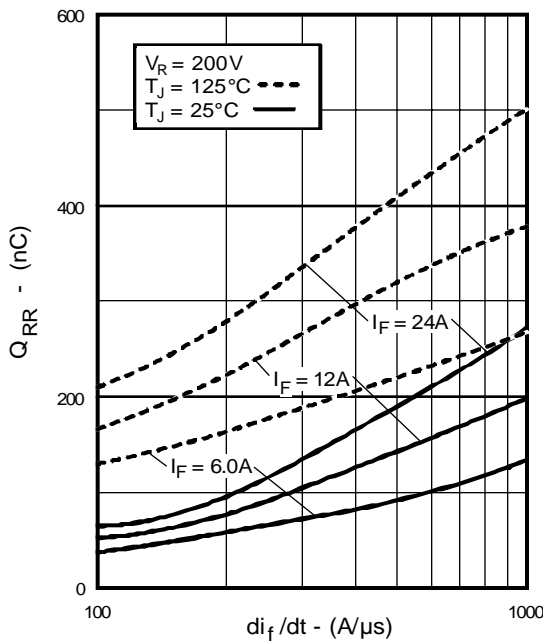

**Fig. 16** - Typical Stored Charge vs.  $di_f/dt$

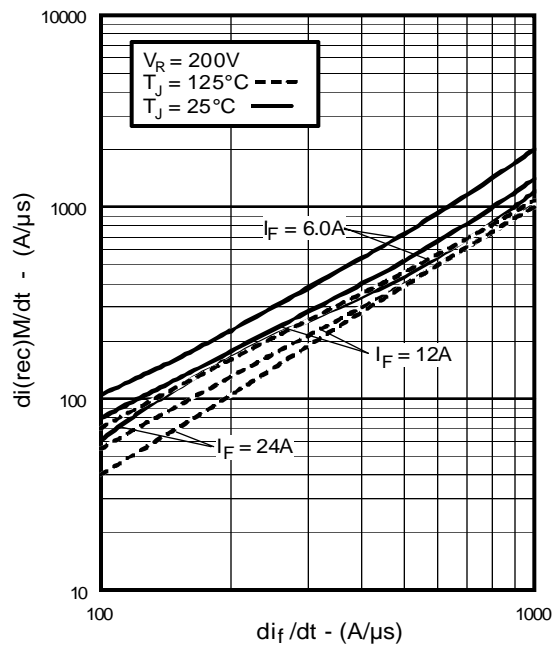

**Fig. 17** - Typical  $di_{(rec)}M/dt$  vs.  $di_f/dt$

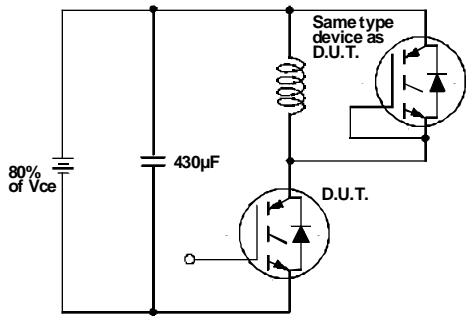

**Fig. 18a** - Test Circuit for Measurement of  $I_{LM}$ ,  $E_{on}$ ,  $E_{off}(\text{diode})$ ,  $t_{rr}$ ,  $Q_{rr}$ ,  $I_{rr}$ ,  $t_{d(on)}$ ,  $t_r$ ,  $t_{d(off)}$ ,  $t_f$

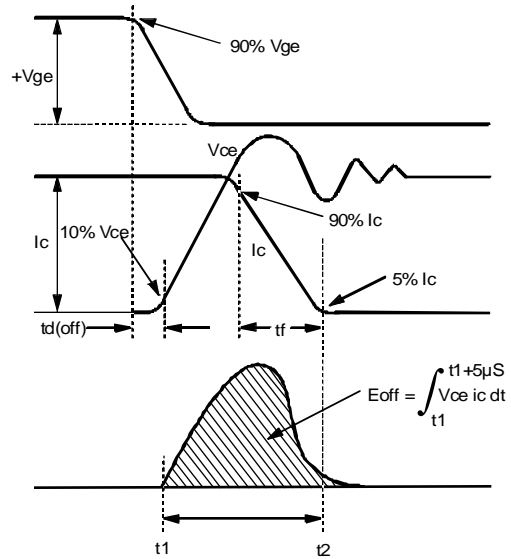

**Fig. 18b** - Test Waveforms for Circuit of Fig. 18a, Defining  $E_{off}$ ,  $t_{d(off)}$ ,  $t_f$

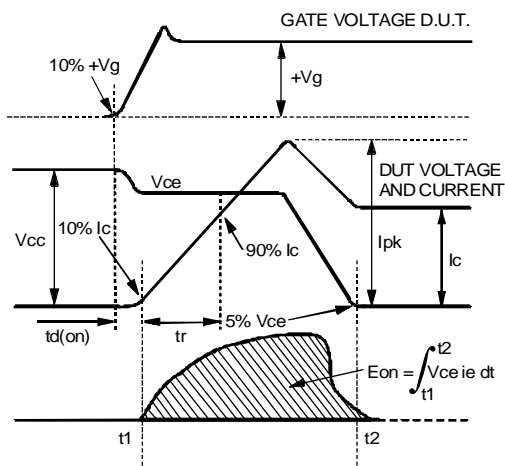

**Fig. 18c** - Test Waveforms for Circuit of Fig. 18a, Defining  $E_{on}$ ,  $t_{d(on)}$ ,  $t_r$

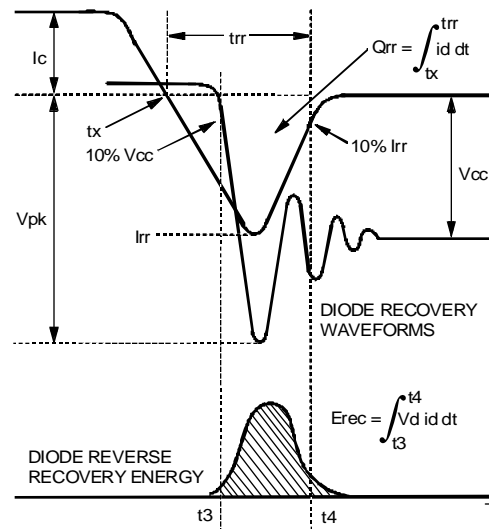
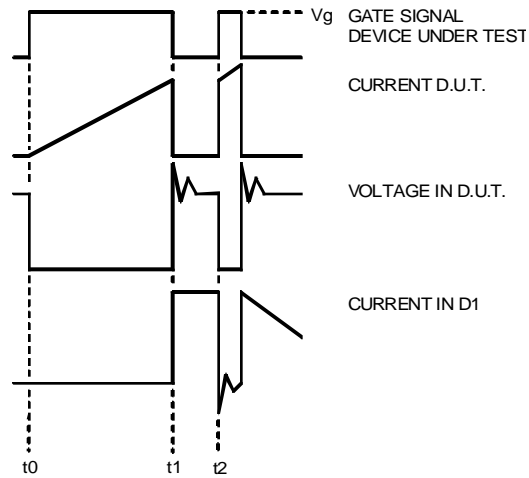

**Fig. 18d** - Test Waveforms for Circuit of Fig. 18a, Defining  $E_{rec}$ ,  $t_{rr}$ ,  $Q_{rr}$ ,  $I_{rr}$





# IRGPC30FD2



**Fig. 18e - Macro Waveforms for Test Circuit of Fig. 18a**

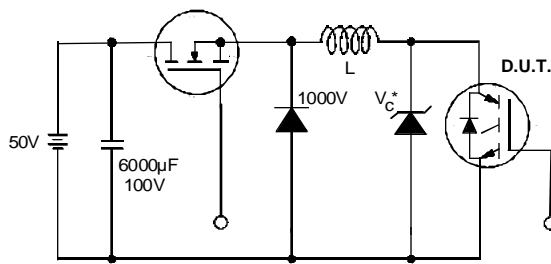

**Fig. 19 - Clamped Inductive Load Test Circuit**

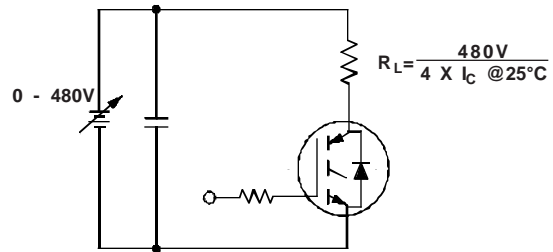

**Fig. 20 - Pulsed Collector Current Test Circuit**

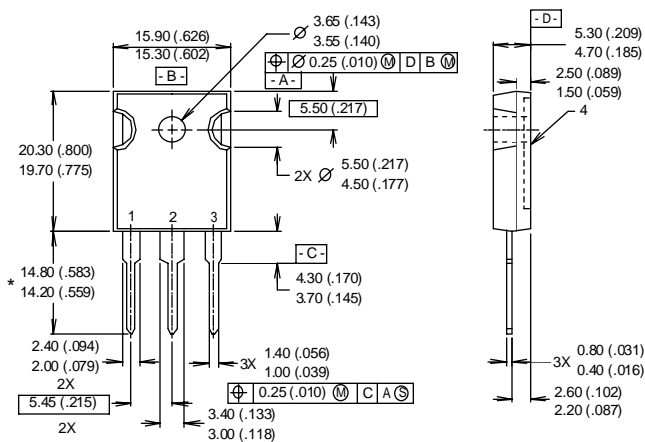

- NOTES:
- 1 DIMENSIONS & TOLERANCING PER ANSI Y14.5M, 1982.
  - 2 CONTROLLING DIMENSION: INCH.
  - 3 DIMENSIONS ARE SHOWN MILLIMETERS (INCHES).
  - 4 CONFORMS TO JEDEC OUTLINE TO-247AC.

- LEAD ASSIGNMENTS
- 1 - GATE
  - 2 - COLLECTOR
  - 3 - EMITTER
  - 4 - COLLECTOR

\* LONGER LEADED (20mm) VERSION AVAILABLE (TO-247AD) TO ORDER ADD "E" SUFFIX TO PART NUMBER

**CONFORMS TO JEDEC OUTLINE TO-247AC (TO-3P)**  
Dimensions in Millimeters and (Inches)

Note: For the most current drawings please refer to the IR website at:  
<http://www.irf.com/package/>