

Features

- Switching-loss rating includes all "tail" losses
- Optimized for high operating frequency (over 5kHz) See Fig. 1 for Current vs. Frequency curve

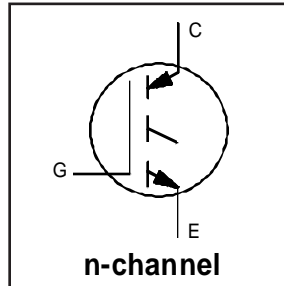

$V_{CES} = 500V$

$V_{CE(sat)} \leq 3.0V$

@ $V_{GE} = 15V, I_C = 15A$

Description

Insulated Gate Bipolar Transistors (IGBTs) from International Rectifier have higher usable current densities than comparable bipolar transistors, while at the same time having simpler gate-drive requirements of the familiar power MOSFET. They provide substantial benefits to a host of high-voltage, high-current applications.

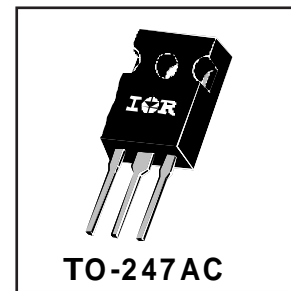

Absolute Maximum Ratings

| | Parameter | Max. | Units |
|---------------------------|--|--------------------|------------|
| V_{CES} | Collector-to-Emitter Voltage | 500 | V |
| $I_C @ T_C = 25^\circ C$ | Continuous Collector Current | 25 | A |
| $I_C @ T_C = 100^\circ C$ | Continuous Collector Current | 15 | |
| I_{CM} | Pulsed Collector Current ① | 50 | |
| I_{LM} | Clamped Inductive Load Current ② | 50 | |
| V_{GE} | Gate-to-Emitter Voltage | ± 20 | V |
| E_{ARV} | Reverse Voltage Avalanche Energy ③ | 10 | mJ |
| $P_D @ T_C = 25^\circ C$ | Maximum Power Dissipation | 100 | W |
| $P_D @ T_C = 100^\circ C$ | Maximum Power Dissipation | 42 | |
| T_J | Operating Junction and Storage Temperature Range | -55 to +150 | $^\circ C$ |
| T_{STG} | | | |
| | | | |
| | Mounting torque, 6-32 or M3 screw. | 10 lbf•in (1.1N•m) | |

Thermal Resistance

| | Parameter | Min. | Typ. | Max. | Units |
|-----------------|---|-------|----------|-------|--------------|
| $R_{\theta JC}$ | Junction-to-Case | ----- | ----- | 1.2 | $^\circ C/W$ |
| $R_{\theta CS}$ | Case-to-Sink, flat, greased surface | ----- | 0.24 | ----- | |
| $R_{\theta JA}$ | Junction-to-Ambient, typical socket mount | ----- | ----- | 40 | |
| Wt | Weight | ----- | 6 (0.21) | ----- | g (oz) |

Electrical Characteristics @ $T_J = 25^\circ\text{C}$ (unless otherwise specified)

| | Parameter | Min. | Typ. | Max. | Units | Conditions |
|---------------------------------|--|------|------|-----------|---------------------|---|
| $V_{(BR)CES}$ | Collector-to-Emitter Breakdown Voltage | 500 | ---- | ---- | V | $V_{GE} = 0V, I_C = 250\mu A$ |
| $V_{(BR)ECS}$ | Emitter-to-Collector Breakdown Voltage ① | 20 | ---- | ---- | V | $V_{GE} = 0V, I_C = 1.0A$ |
| $\Delta V_{(BR)CES}/\Delta T_J$ | Temperature Coeff. of Breakdown Voltage | ---- | 0.46 | ---- | $V/^\circ\text{C}$ | $V_{GE} = 0V, I_C = 1.0mA$ |
| $V_{CE(on)}$ | Collector-to-Emitter Saturation Voltage | ---- | 2.3 | 3.0 | V | $I_C = 15A, V_{GE} = 15V$ $I_C = 25A$ $I_C = 15A, T_J = 150^\circ\text{C}$ See Fig. 2, 5 |
| | | ---- | 2.8 | ---- | | |
| | | ---- | 2.6 | ---- | | |
| $V_{GE(th)}$ | Gate Threshold Voltage | 3.0 | ---- | 5.5 | | $V_{CE} = V_{GE}, I_C = 250\mu A$ |
| $\Delta V_{GE(th)}/\Delta T_J$ | Temperature Coeff. of Threshold Voltage | ---- | -11 | ---- | $mV/^\circ\text{C}$ | $V_{CE} = V_{GE}, I_C = 250\mu A$ |
| g_{fe} | Forward Transconductance ⑤ | 2.3 | 8.1 | ---- | S | $V_{CE} = 100V, I_C = 15A$ |
| I_{CES} | Zero Gate Voltage Collector Current | ---- | ---- | 250 | μA | $V_{GE} = 0V, V_{CE} = 500V$ |
| | | ---- | ---- | 1000 | | $V_{GE} = 0V, V_{CE} = 500V, T_J = 150^\circ\text{C}$ |
| I_{GES} | Gate-to-Emitter Leakage Current | ---- | ---- | ± 100 | nA | $V_{GE} = \pm 20V$ |

Switching Characteristics @ $T_J = 25^\circ\text{C}$ (unless otherwise specified)

| | Parameter | Min. | Typ. | Max. | Units | Conditions |
|--------------|-----------------------------------|------|------|------|-------|---|
| Q_g | Total Gate Charge (turn-on) | ---- | 31 | 47 | nC | $I_C = 15A$ $V_{CC} = 400V$ $V_{GE} = 15V$ See Fig. 8 |
| Q_{ge} | Gate - Emitter Charge (turn-on) | ---- | 6.2 | 9.3 | | |
| Q_{gc} | Gate - Collector Charge (turn-on) | ---- | 12 | 19 | | |
| $t_{d(on)}$ | Turn-On Delay Time | ---- | 29 | ---- | ns | $T_J = 25^\circ\text{C}$ $I_C = 15A, V_{CC} = 400V$ $V_{GE} = 15V, R_G = 23\Omega$ Energy losses include "tail" |
| t_r | Rise Time | ---- | 11 | ---- | | |
| $t_{d(off)}$ | Turn-Off Delay Time | ---- | 91 | 160 | | |
| t_f | Fall Time | ---- | 66 | 120 | mJ | See Fig. 9, 10, 11, 14 |
| E_{on} | Turn-On Switching Loss | ---- | 0.24 | ---- | | |
| E_{off} | Turn-Off Switching Loss | ---- | 0.17 | ---- | | |
| E_{ts} | Total Switching Loss | ---- | 0.41 | 0.61 | ns | $T_J = 150^\circ\text{C}$, $I_C = 15A, V_{CC} = 400V$ $V_{GE} = 15V, R_G = 23\Omega$ Energy losses include "tail" |
| $t_{d(on)}$ | Turn-On Delay Time | ---- | 13 | ---- | | |
| t_r | Rise Time | ---- | 27 | ---- | | |
| $t_{d(off)}$ | Turn-Off Delay Time | ---- | 130 | ---- | mJ | See Fig. 10, 14 |
| t_f | Fall Time | ---- | 130 | ---- | | |
| E_{ts} | Total Switching Loss | ---- | 0.76 | ---- | | |
| L_E | Internal Emitter Inductance | ---- | 13 | ---- | nH | Measured 5mm from package |
| C_{ies} | Input Capacitance | ---- | 660 | ---- | pF | $V_{GE} = 0V$ $V_{CC} = 30V$ $f = 1.0MHz$ See Fig. 7 |
| C_{oes} | Output Capacitance | ---- | 110 | ---- | | |
| C_{res} | Reverse Transfer Capacitance | ---- | 12 | ---- | | |

Notes:

- ① Repetitive rating; $V_{GE}=20V$, pulse width limited by max. junction temperature. (See fig. 13b)
- ② $V_{CC}=80\%(V_{CES}), V_{GE}=20V, L=10\mu H, R_G=23\Omega$, (See fig. 13a)
- ③ Repetitive rating; pulse width limited by maximum junction temperature.
- ④ Pulse width $\leq 80\mu s$; duty factor $\leq 0.1\%$.
- ⑤ Pulse width 5.0 μs , single shot.

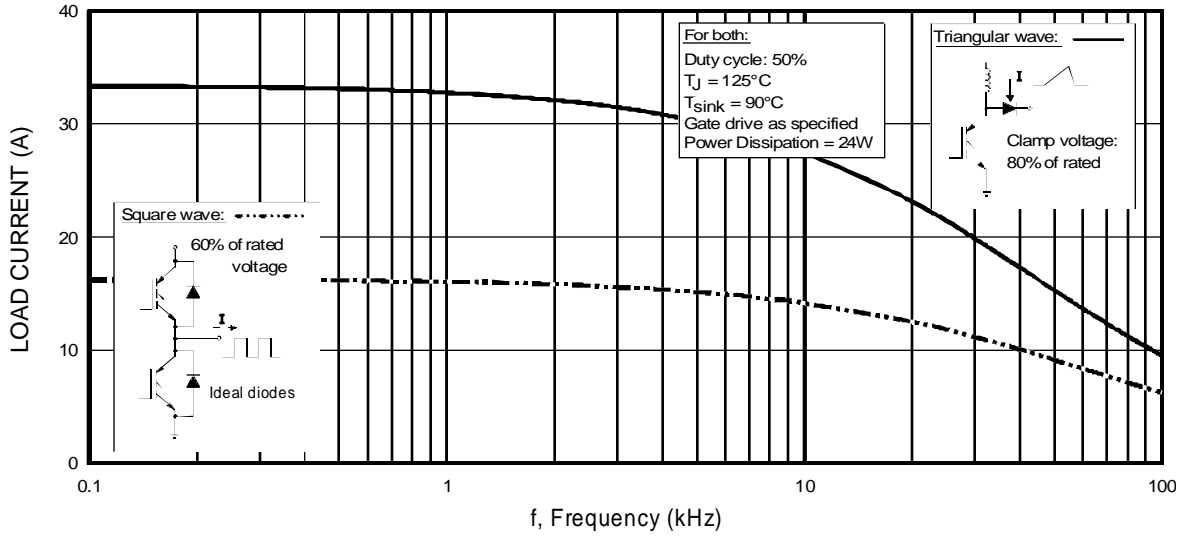

Fig. 1 - Typical Load Current vs. Frequency
 (For square wave, $I = I_{RMS}$ of fundamental; for triangular wave, $I = I_{PK}$)

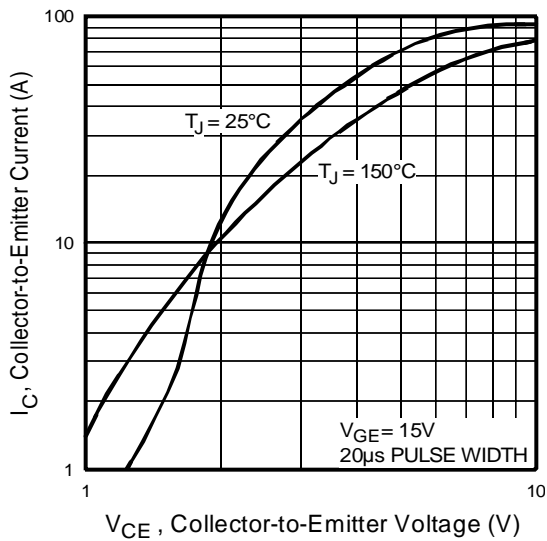

Fig. 2 - Typical Output Characteristics

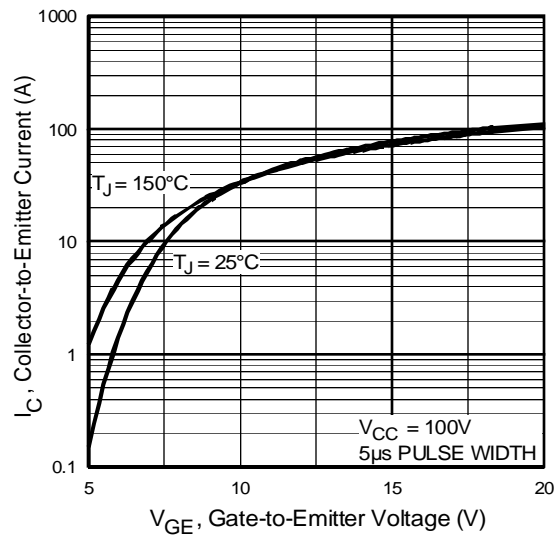

Fig. 3 - Typical Transfer Characteristics

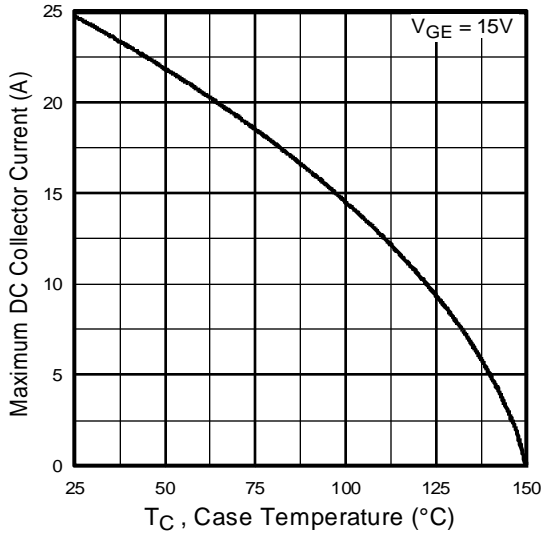

Fig. 4 - Maximum Collector Current vs. Case Temperature

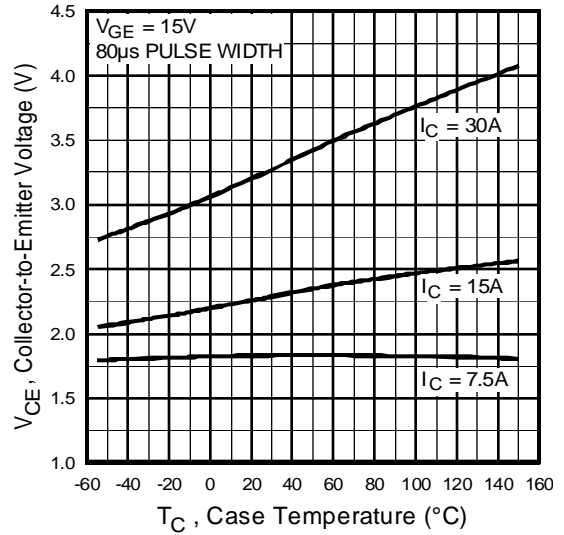

Fig. 5 - Collector-to-Emitter Voltage vs. Case Temperature

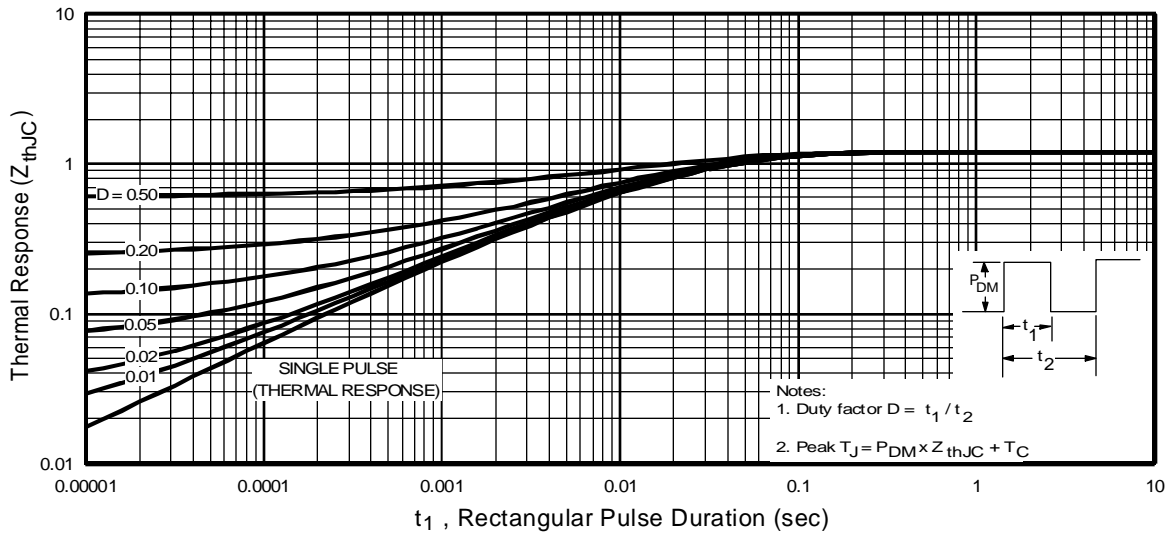

Fig. 6 - Maximum Effective Transient Thermal Impedance, Junction-to-Case

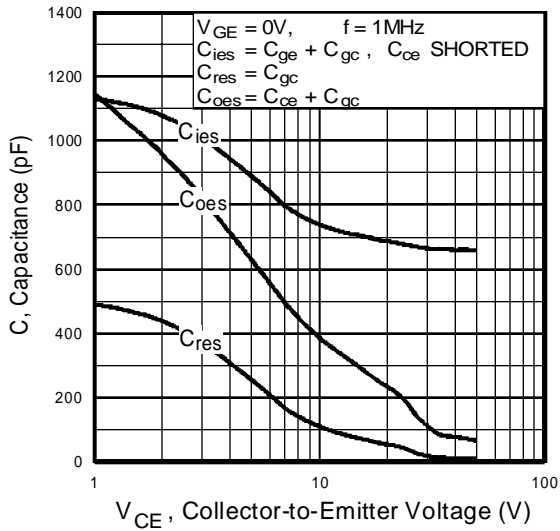

Fig. 7 - Typical Capacitance vs. Collector-to-Emitter Voltage

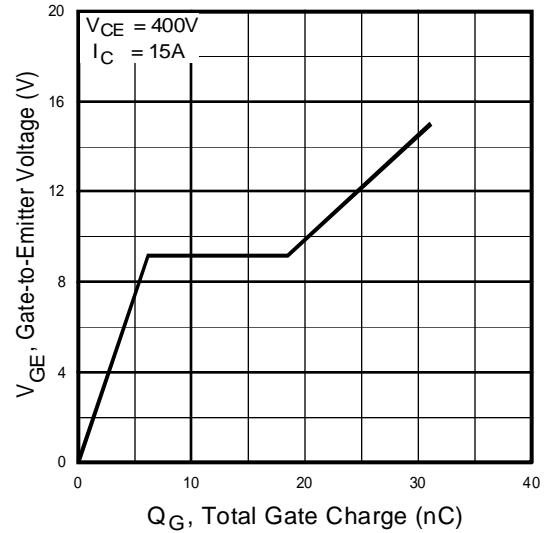

Fig. 8 - Typical Gate Charge vs. Gate-to-Emitter Voltage

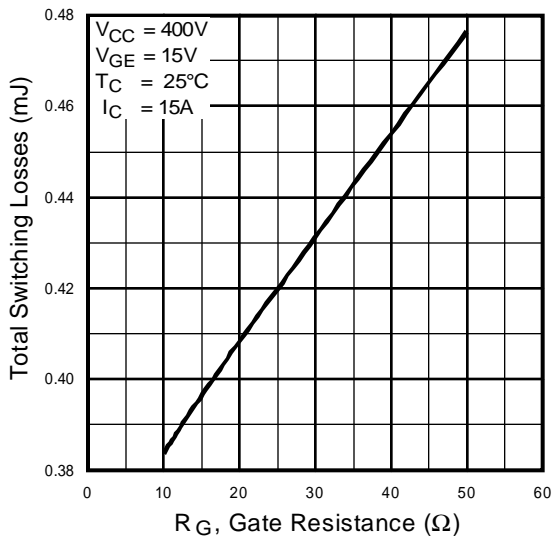

Fig. 9 - Typical Switching Losses vs. Gate Resistance

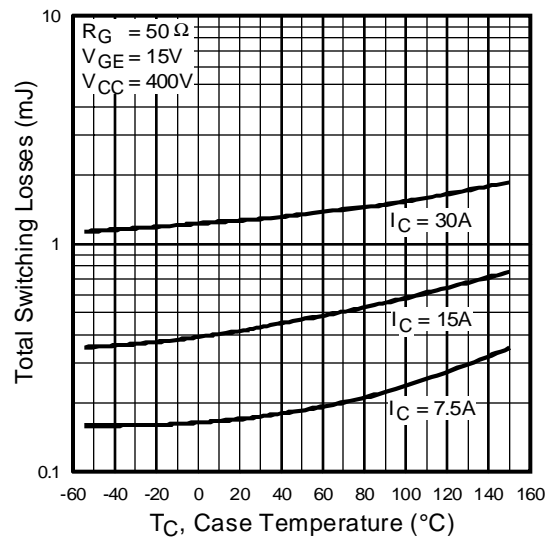

Fig. 10 - Typical Switching Losses vs. Case Temperature

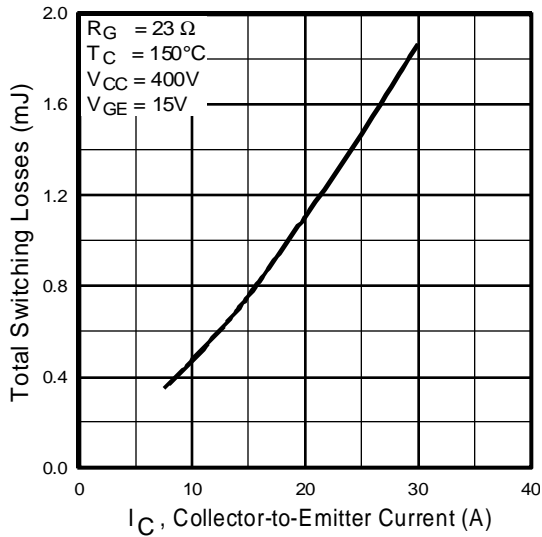

Fig. 11 - Typical Switching Losses vs. Collector-to-Emitter Current

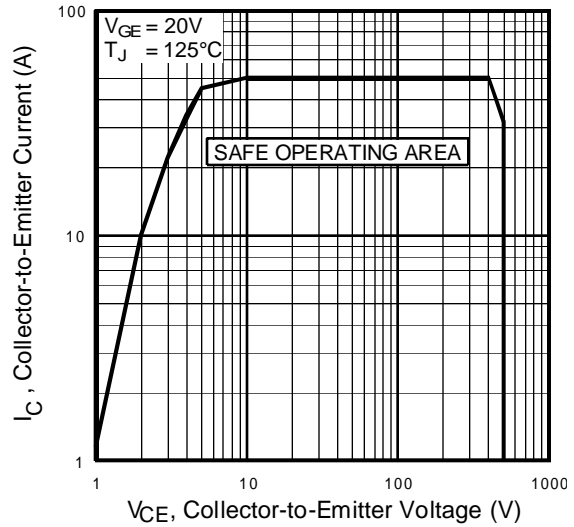
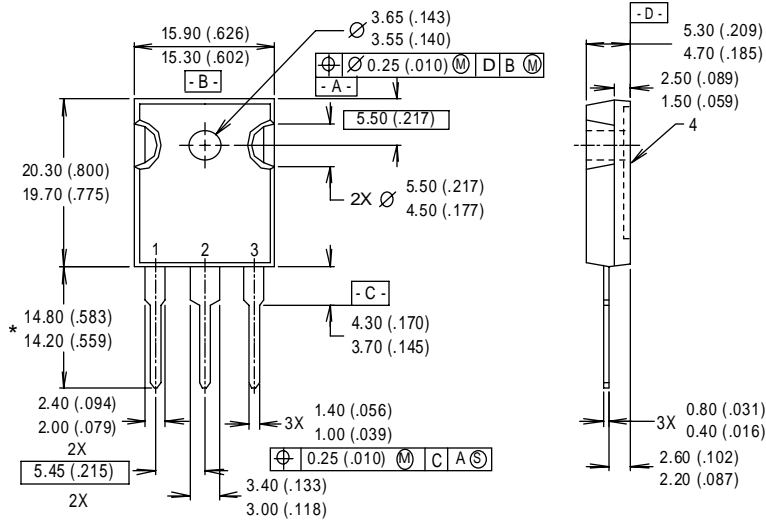

Fig. 12 - Turn-Off SOA



NOTES:
 1 DIMENSIONS & TOLERANCING PER ANSI Y14.5M, 1982.
 2 CONTROLLING DIMENSION : INCH.
 3 DIMENSIONS ARE SHOWN MILLIMETERS (INCHES).
 4 CONFORMS TO JEDEC OUTLINE TO-247AC.

LEAD ASSIGNMENTS
 1 - GATE
 2 - COLLECTOR
 3 - EMITTER
 4 - COLLECTOR

* LONGER LEADED (20mm) VERSION AVAILABLE (TO-247AD) TO ORDER ADD "-E" SUFFIX TO PART NUMBER

CONFORMS TO JEDEC OUTLINE TO-247AC (TO-3P)

Dimensions in Millimeters and (Inches)

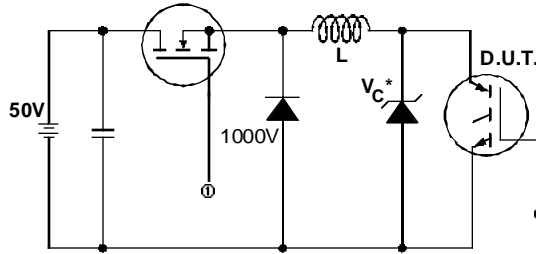

* Driver same type as D.U.T.; $V_c = 80\%$ of $V_{ce(max)}$
 * Note: Due to the 50V power supply, pulse width and inductor will increase to obtain rated I_d .

Fig. 13a - Clamped Inductive Load Test Circuit

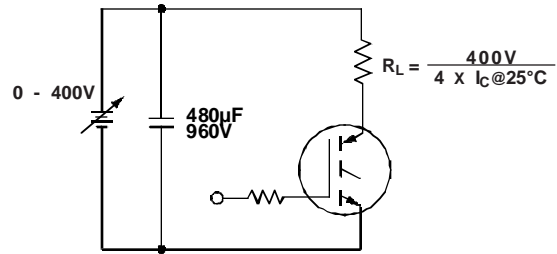

Fig. 13b - Pulsed Collector Current Test Circuit

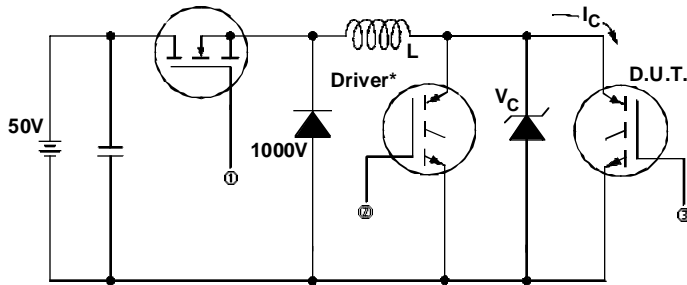

Fig. 14a - Switching Loss Test Circuit

* Driver same type as D.U.T., $V_C = 400V$

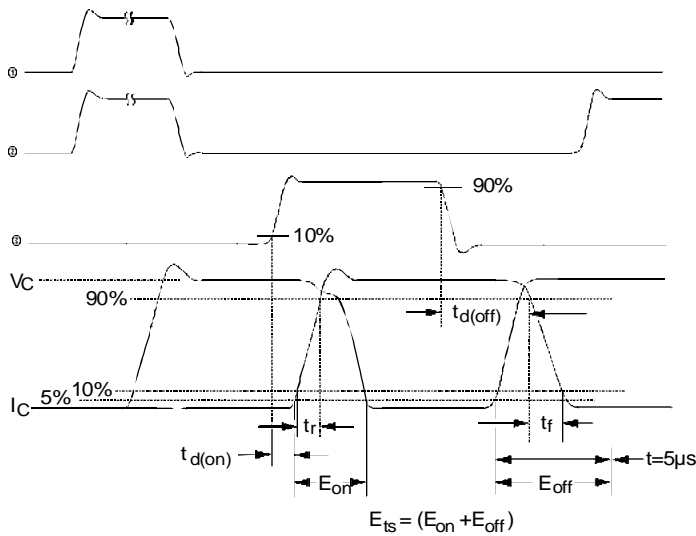

Fig. 14b - Switching Loss Waveforms

Note: For the most current drawings please refer to the IR website at:
<http://www.irf.com/package/>