

INTERNATIONAL RECTIFIER

REPETITIVE AVALANCHE RATED AND dv/dt RATED

HEXFET[®] TRANSISTOR

IRFM150

2N7224

JANTX2N7224

JANTXV2N7224

[REF: MIL-S-19500/592]

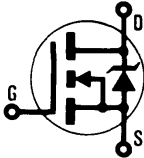

N-CHANNEL

100 Volt, 0.07 Ohm HEXFET

The HEXFET[®] technology is the key to International Rectifier's advanced line of power MOSFET transistors. The efficient geometry design achieves very low on-state resistance combined with high transconductance.

The HEXFET transistors also feature all of the well established advantages of MOSFETs such as voltage control, very fast switching, ease of paralleling and temperature stability of the electrical parameters.

They are well suited for applications such as switching power supplies and virtually any application where military and/or high reliability is required.

Product Summary

Part Number	BV_{DSS}	$R_{DS(on)}$	I_D
IRFM150	100V	0.07 Ω	34A

FEATURES:

- Repetitive Avalanche Rating
- Isolated and Hermetically Sealed
- Alternative to TO-3 Package
- Simple Drive Requirements
- Ease of Paralleling
- Ceramic Eyelets

CASE STYLE AND DIMENSIONS

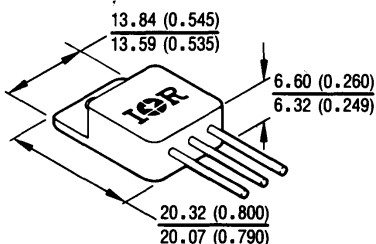

CAUTION

BERYLLIA WARNING PER MIL-S-19500
SEE PAGE I-308

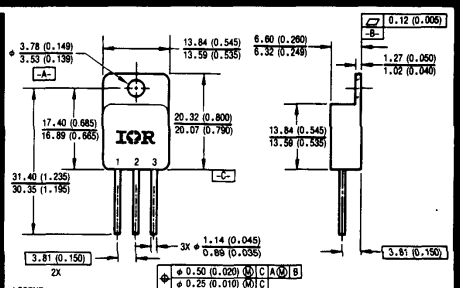

LEGEND

- 1 DRAIN
- 2 SOURCE
- 3 GATE

NOTES:

- 1 DIMENSIONING & TOLERANCING PER ANS Y14.5M - 1982.
- 2 ALL DIMENSIONS ARE SHOWN IN MILLIMETERS (INCHES).

Conforms to JEDEC Outline TO-254AA*
Dimensions in Millimeters and (Inches)

*For leadform configurations see page I-308, fig. 15



Absolute Maximum Ratings

Parameter	IRFM150, JANTXV, JANTX-, 2N7224	Units
$I_D @ V_{GS} = 10V, T_C = 25^\circ C$ Continuous Drain Current	34	A
$I_D @ V_{GS} = 10V, T_C = 100^\circ C$ Continuous Drain Current	21	
I_{DM} Pulsed Drain Current ①	136	
$P_D @ T_C = 25^\circ C$ Max. Power Dissipation	150	W
Linear Derating Factor	1.2	W/K ⑤
V_{GS} Gate-to-Source Voltage	± 20	V
E_{AS} Single Pulse Avalanche Energy ②	150 (See Fig. 12)	mJ
I_{AR} Avalanche Current ①	34 (See E_{AR})	A
E_{AR} Repetitive Avalanche Energy ①	15 (See Fig. 13)	mJ
dv/dt Peak Diode Recovery dv/dt ③	5.5 (See Fig. 13)	V/ns
T_J Operating Junction Temperature Range	-55 to 150	°C
T_{STG} Storage Temperature Range		
Lead Temperature	300 (0.063 in. (1.6 mm) from case for 10s)	
Weight	9.3 (typical)	g

Electrical Characteristics @ $T_J = 25^\circ C$ (Unless Otherwise Specified)

Parameter	Min.	Typ.	Max.	Units	Test Conditions
BV_{DSS} Drain-to-Source Breakdown Voltage	100	—	—	V	$V_{GS} = 0V, I_D = 1.0 mA$
$\Delta BV_{DSS}/\Delta T_J$ Temperature Coefficient of Breakdown Voltage	—	0.13	—	V/°C	Reference to 25°C, $I_D = 1.0 mA$
$R_{DS(on)}$ Static Drain-to-Source On-State Resistance	—	—	0.07	Ω	$V_{GS} = 10V, I_D = 21A$ ④
	—	—	0.081		
$V_{GS(th)}$ Gate Threshold Voltage	2.0	—	4.0	V	$V_{DS} = V_{GS}, I_D = 250 \mu A$
g_{fs} Forward Transconductance	9.0	—	—	S (①)	$V_{DS} \geq 15V, I_{DS} = 21A$ ④
I_{DSS} Zero Gate Voltage Drain Current	—	—	25	μA	$V_{DS} = 0.8 \times \text{Max. Rating}, V_{GS} = 0V$ $V_{DS} = 0.8 \times \text{Max. Rating}$ $V_{GS} = 0V, T_J = 125^\circ C$
	—	—	250		
I_{GSS} Gate-to-Source Leakage Forward	—	—	100	nA	$V_{GS} = 20V$
I_{GSS} Gate-to-Source Leakage Reverse	—	—	-100	nA	$V_{GS} = -20V$
Q_g Total Gate Charge	50	—	125	nC	$V_{GS} = 10V, I_D = 34A$ $V_{DS} = 0.5 \times \text{Max. Rating}$ See Fig. 6 and 14
Q_{gs} Gate-to-Source Charge	8	—	22		
Q_{gd} Gate-to-Drain ("Miller") Charge	15	—	65		
$t_{d(on)}$ Turn-On Delay Time	—	—	35	ns	$V_{DD} = 50V, I_D = 34A, R_G = 2.35\Omega$ See Fig. 11
t_r Rise Time	—	—	190		
$t_{d(off)}$ Turn-Off Delay Time	—	—	170		
t_f Fall Time	—	—	130		
L_D Internal Drain Inductance	—	8.7	—	nH	Measured from the drain lead, 6 mm (0.25 in.) from package to center of die. Modified MOSFET symbol showing the internal inductances. 
L_S Internal Source Inductance	—	8.7	—		
C_{iss} Input Capacitance	—	3700	—	pF	$V_{GS} = 0V, V_{DS} = 25V$ $f = 1.0 MHz$ See Fig. 5
C_{oss} Output Capacitance	—	1100	—		
C_{rss} Reverse Transfer Capacitance	—	200	—		
C_{DC} Drain-to-Case Capacitance	—	12	—		



Source-Drain Diode Ratings and Characteristics

Parameter		Min.	Typ.	Max.	Units	Test Conditions
I_S	Continuous Source Current (Body Diode)	—	—	34	A	Modified MOSFET symbol showing the integral Reverse p-n junction rectifier. 
I_{SM}	Pulsed Source Current (Body Diode) ①	—	—	136		
V_{SD}	Diode Forward Voltage	—	—	1.8	V	$T_J = 25^\circ\text{C}$, $I_S = 34\text{A}$, $V_{GS} = 0\text{V}$ ④
t_{rr}	Reverse Recovery Time	—	—	500	nS	$T_J = 25^\circ\text{C}$, $I_F = 34\text{A}$, $di/dt \leq 100\text{ A}/\mu\text{s}$ ④
Q_{RR}	Reverse Recovery Charge	—	—	2.9	μC	$V_{DD} \leq 50\text{V}$
t_{on}	Forward Turn-On Time	Intrinsic turn-on time is negligible. Turn-on speed is substantially controlled by $L_S + L_D$.				

Thermal Resistance

Parameter		Min.	Typ.	Max.	Units	Test Conditions
R_{thJC}	Junction-to-Case	—	—	0.83	K/W ⑤	Mounting surface flat, smooth, and greased
R_{thCS}	Case-to-Sink	—	0.21	—		
R_{thJA}	Junction-to-Ambient	—	—	48		

① Repetitive Rating: Pulse width limited by maximum junction temperature (see figure 9) Refer to current HEXFET reliability report

② @ $V_{DD} = 25\text{V}$, Starting $T_J = 25^\circ\text{C}$,
 $L \geq 200\ \mu\text{H}$, $R_G = 25\ \Omega$,
 Peak $I_L = 34\text{A}$

③ $I_{SD} \leq 34\text{A}$, $di/dt \leq 70\text{ A}/\mu\text{s}$,
 $V_{DD} \leq BV_{DSS}$, $T_J \leq 150^\circ\text{C}$
 Suggested $R_G = 2.35\ \Omega$

④ Pulse width $\leq 300\ \mu\text{s}$; Duty Cycle $\leq 2\%$

⑤ $\text{K/W} = ^\circ\text{C}/\text{W}$
 $\text{W/K} = \text{W}/^\circ\text{C}$

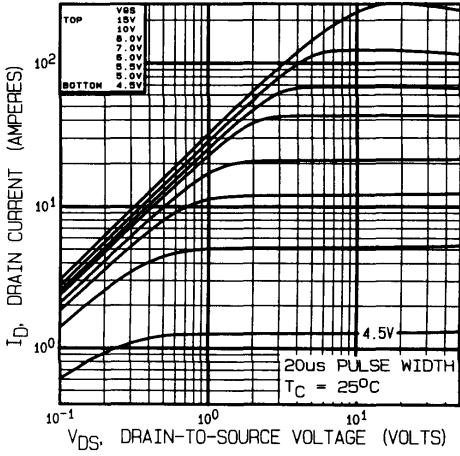

Fig. 1 — Typical Output Characteristics, $T_C = 25^\circ\text{C}$

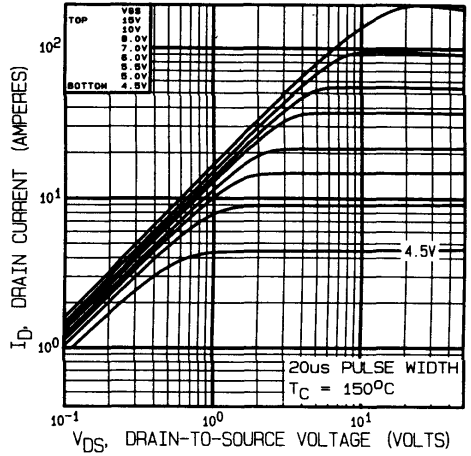

Fig. 2 — Typical Output Characteristics, $T_C = 150^\circ\text{C}$

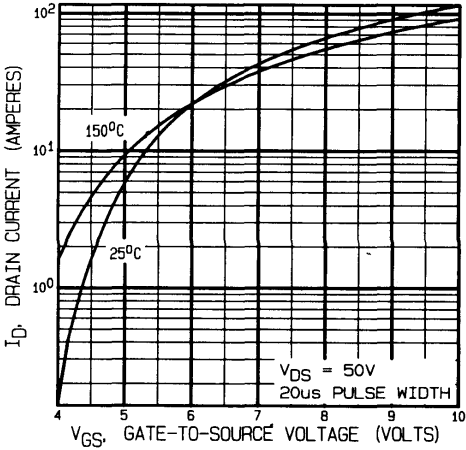

Fig. 3 — Typical Transfer Characteristics

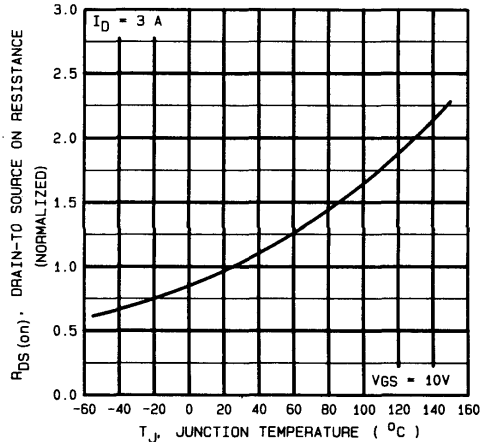

Fig. 4 — Normalized On-Resistance vs. Temperature

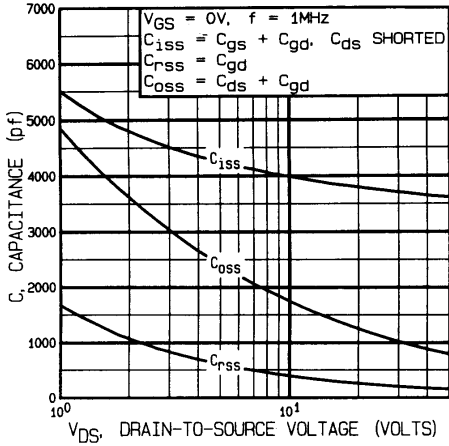

Fig. 5 — Typical Capacitance Vs. Drain-to-Source Voltage

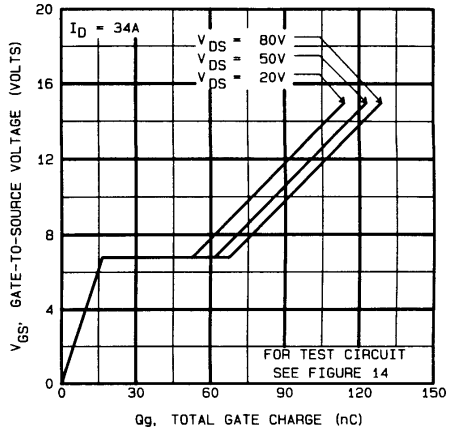

Fig. 6 — Typical Gate Charge Vs. Gate-to-Source Voltage

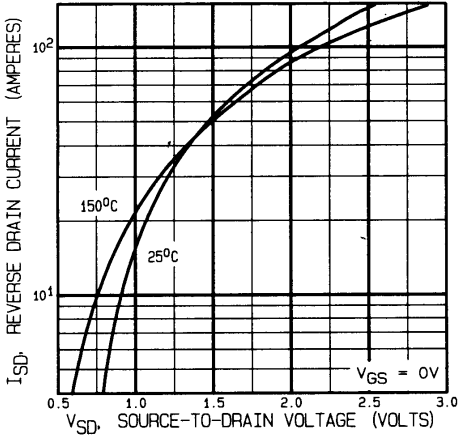

Fig. 7 — Typical Source-Drain Diode Forward Voltage

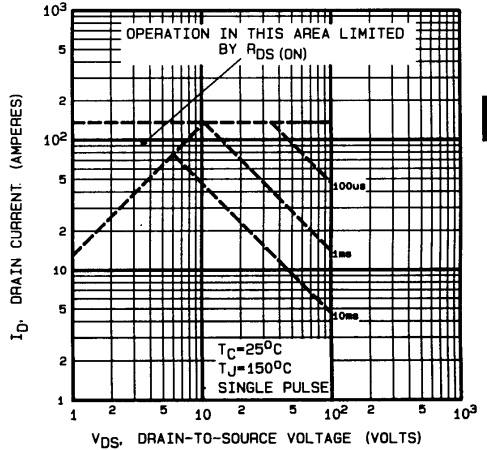

Fig. 8 — Maximum Safe Operating Area

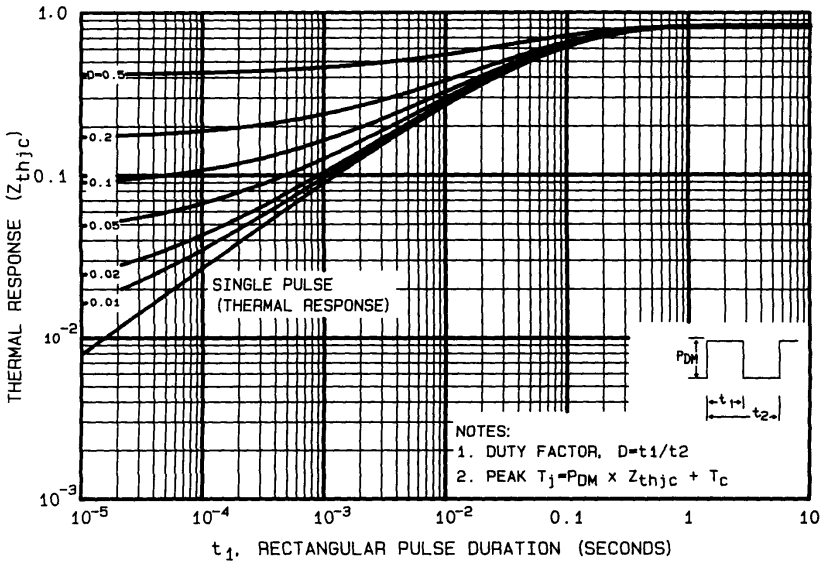

Fig. 9 — Maximum Effective Transient Thermal Impedance, Junction-to-Case Vs. Pulse Duration

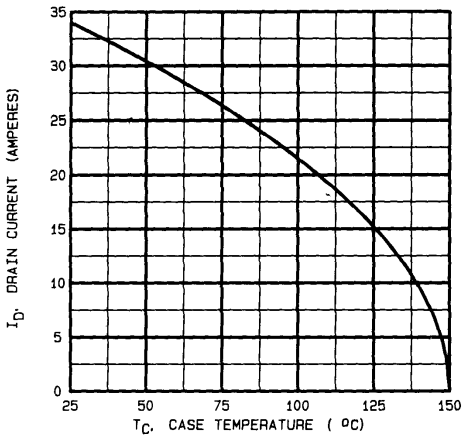

Fig. 10 — Maximum Drain Current Vs. Case Temperature

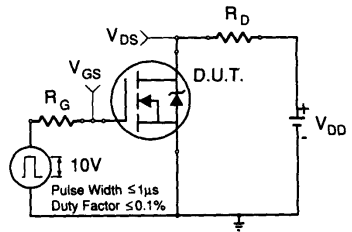

Fig. 11a — Switching Time Test Circuit

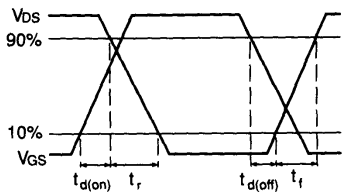
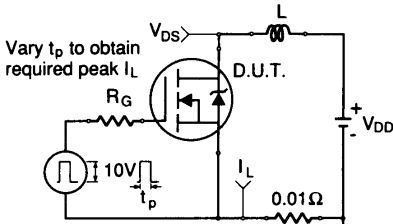
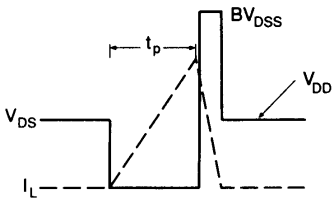
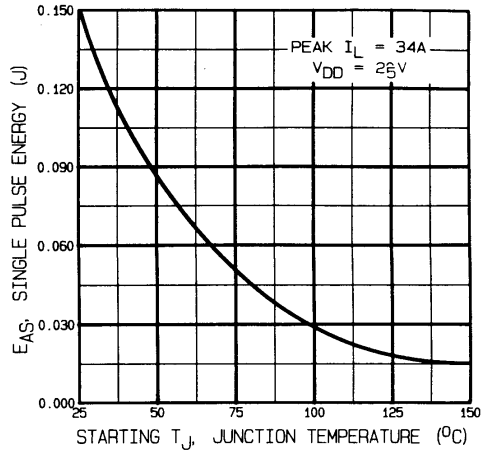
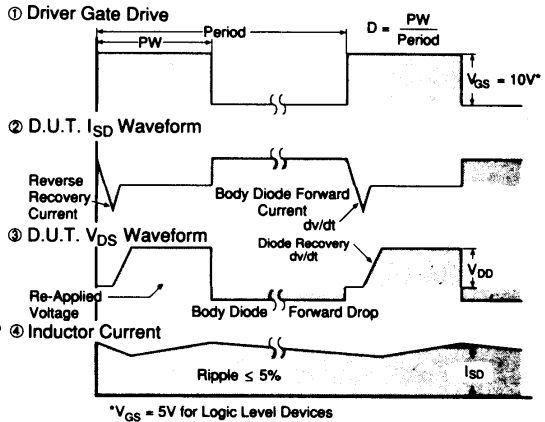
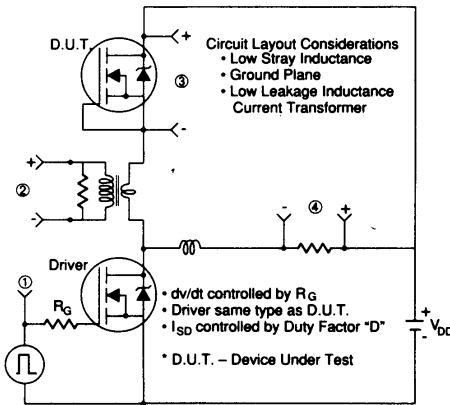

Fig. 11b — Switching Time Waveforms

Fig. 12a — Unclamped Inductive Test Circuit

Fig. 12b — Unclamped Inductive Waveforms

Fig. 12c — Maximum Avalanche Energy Vs. Starting Junction Temperature

Fig. 13 — Peak Diode Recovery dv/dt Test Circuit

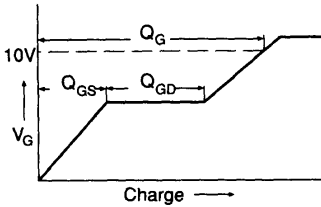

Fig. 14a — Basic Gate Charge Waveform

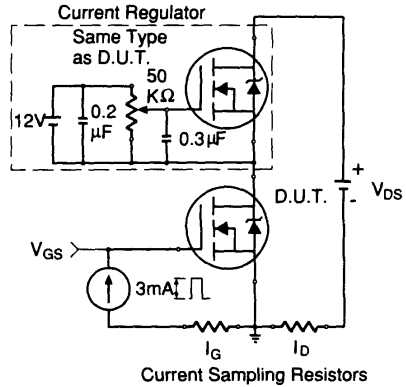

Fig. 14b — Gate Charge Test Circuit

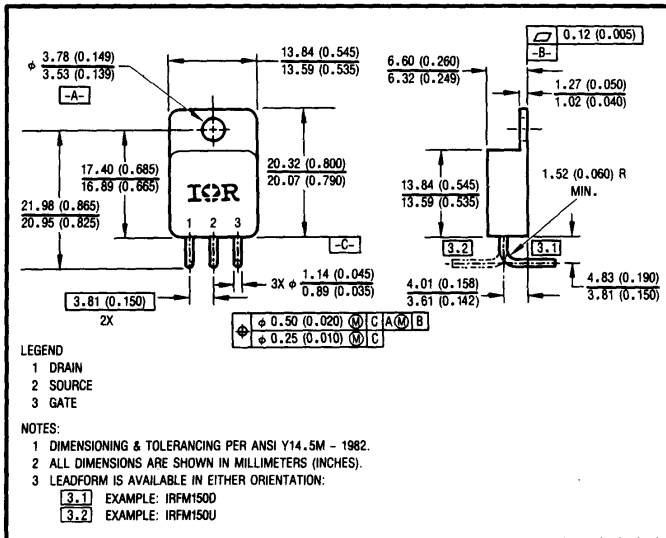

Fig. 15 — Optional Leadforms for Outline TO-254

BERYLLIA WARNING PER MIL-S-19500
 Packages containing beryllia shall not be ground, sandblasted, machined, or have other operations performed on them which will produce beryllia or beryllium dust. Furthermore, beryllium oxide packages shall not be placed in acids that will produce fumes containing beryllium.