

International
IR Rectifier
HEXFET[®] Power MOSFET

PD-95923

IRFD224PbF

- Dynamic dv/dt Rating
- Repetitive Avalanche Rated
- For Automatic Insertion
- End Stackable
- Fast Switching
- Ease of paralleling
- Simple Drive Requirements
- Lead-Free

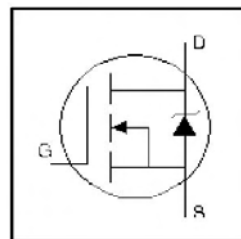

$V_{DSS} = 250V$
$R_{DS(on)} = 1.1\Omega$
$I_D = 0.63A$

Description

Third Generation HEXFETs from International Rectifier provide the designer with the best combination of fast switching, ruggedized device design, low on-resistance and cost-effectiveness.

The 4-pin DIP package is a low-cost machine-insertable case style which can be stacked in multiple combinations on standard 0.1 inch pin centers. The dual drain serves as a thermal link to the mounting surface for power dissipation levels up to 1 watt.

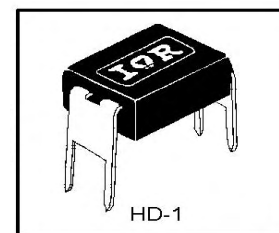

Absolute Maximum Ratings

	Parameter	Max.	Units
$I_D @ T_C = 25^\circ C$	Continuous Drain Current, $V_{GS} @ 10 V$	0.63	A
$I_D @ T_C = 100^\circ C$	Continuous Drain Current, $V_{GS} @ 10 V$	0.40	
I_{DM}	Pulsed Drain Current ①	5.0	
$P_D @ T_C = 25^\circ C$	Power Dissipation	1.0	W
	Linear Derating Factor	0.0083	W/C
V_{GS}	Gate-to-Source Voltage	± 20	V
E_{AS}	Single Pulse Avalanche Energy ②	60	mJ
I_{AR}	Avalanche Current ①	0.63	A
E_{AR}	Repetitive Avalanche Energy ①	0.10	mJ
dv/dt	Peak Diode Recovery dv/dt ③	4.8	V/ns
T_J	Operating Junction and Storage Temperature Range	-55 to + 150	°C
T_{STG}			
	Soldering Temperature, for 10 seconds	300 (1.6mm from case)	

Thermal Resistance

	Parameter	Min.	Typ.	Max.	Units
$R_{\theta JA}$	Junction-to-Ambient	—	—	120	°C/W

Electrical Characteristics @ $T_J = 25^\circ\text{C}$ (unless otherwise specified)

	Parameter	Min.	Typ.	Max.	Units	Conditions
	$V_{(BR)DSS}$	250	—	—	V	$V_{GS} = 0V, I_D = 250\mu A$
	$\Delta V_{(BR)DSS}/\Delta T_J$	—	0.36	—	V/°C	Reference to 25°C , $I_D = 1mA$
	$R_{DS(on)}$	—	—	1.1	Ω	$V_{GS} = 10.0V, I_D = 0.38A$ ④
	$V_{GS(th)}$	2.0	—	4.0	V	$V_{DS} = V_{GS}, I_D = 250\mu A$
	g_{fs}	1.5	—	—	S	$V_{DS} = 50V, I_D = 2.6A$
	I_{DSS}	—	—	25	μA	$V_{DS} = 400V, V_{GS} = 0V$ $V_{DS} = 320V, V_{GS} = 0V, T_J = 125^\circ\text{C}$
	I_{GSS}	—	—	100	nA	$V_{GS} = 20V$
		—	—	-100	nA	$V_{GS} = -20V$
	Q_g	—	—	14	nC	$I_D = 4.4A$
	Q_{gs}	—	—	2.7	nC	$V_{DS} = 200V$
	Q_{gd}	—	—	7.8	nC	$V_{GS} = 10V$, See Fig. 6 and 13 ④
	$t_{d(on)}$	—	7.0	—	ns	$V_{DD} = 125V$
	t_r	—	13	—	ns	$I_D = 4.4A$
	$t_{d(off)}$	—	20	—	ns	$R_G = 18\Omega$
	t_f	—	12	—	ns	$R_D = 28\Omega$, See Fig. 10 ④
	L_D	—	4.0	—	nH	Between lead, 6mm (0.25in.) from package and center of die contact
	L_S	—	6.0	—	nH	
	C_{iss}	—	260	—	pF	$V_{GS} = 0V$
	C_{oss}	—	77	—	pF	$V_{DS} = 25V$
	C_{riss}	—	15	—	pF	$f = 1.0MHz$, See Fig. 5



Source-Drain Ratings and Characteristics

	Parameter	Min.	Typ.	Max.	Units	Conditions
	I_S	—	—	0.63	A	MOSFET symbol showing the integral reverse p-n junction diode.
	I_{SM}	—	—	5.0	A	
	V_{SD}	—	—	1.8	V	$T_J = 25^\circ\text{C}, I_S = 0.63A, V_{GS} = 0V$ ③
	t_{rr}	—	200	400	ns	$T_J = 25^\circ\text{C}, I_F = 4.4A$
	Q_{rr}	—	0.93	1.9	μC	$di/dt = 100A/\mu s$ ④
	t_{on}	Intrinsic turn-on time is negligible (turn-on is dominated by L_S+L_D)				

Notes:

① Repetitive rating; pulse width limited by max. junction temperature. (See fig. 11)

③ $I_{SD} \leq 4.4A, di/dt \leq 90A/\mu s, V_{DD} \leq V_{(BR)DSS}, T_J \leq 150^\circ\text{C}$

② $V_{DD} = 50V, \text{starting } T_J = 25^\circ\text{C}, L = 15mH, R_G = 25\Omega, I_{AS} = 2.5A.$ (See Figure 12)

④ Pulse width $\leq 300\mu s$; duty cycle $\leq 2\%$.

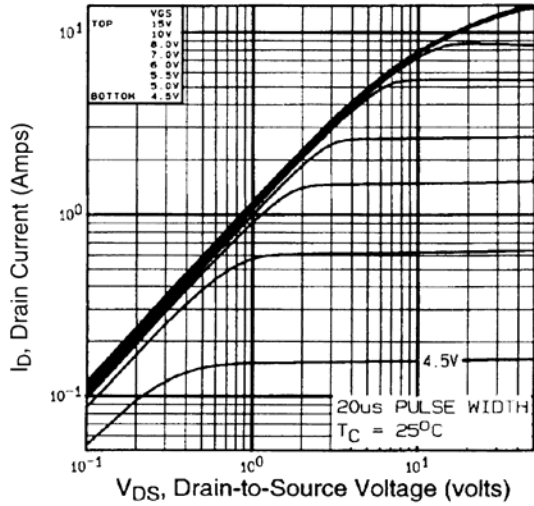

Fig 1. Typical Output Characteristics,
 $T_C = 25^\circ\text{C}$

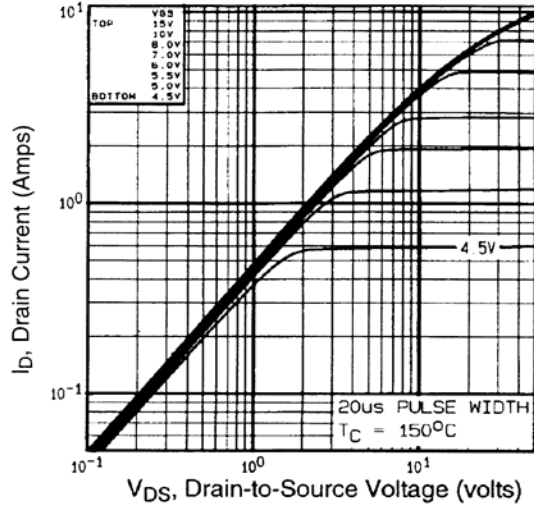

Fig 2. Typical Output Characteristics,
 $T_C = 150^\circ\text{C}$

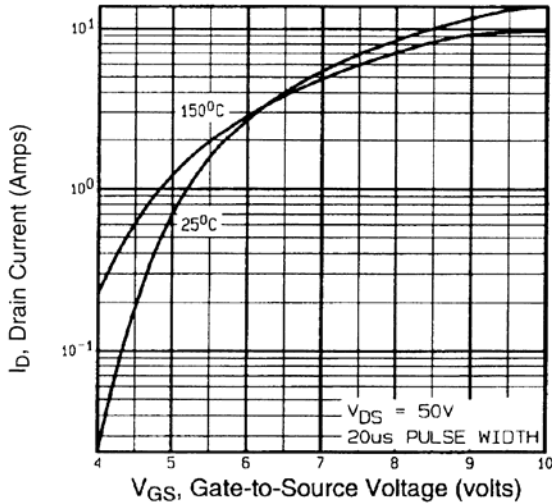

Fig 3. Typical Transfer Characteristics

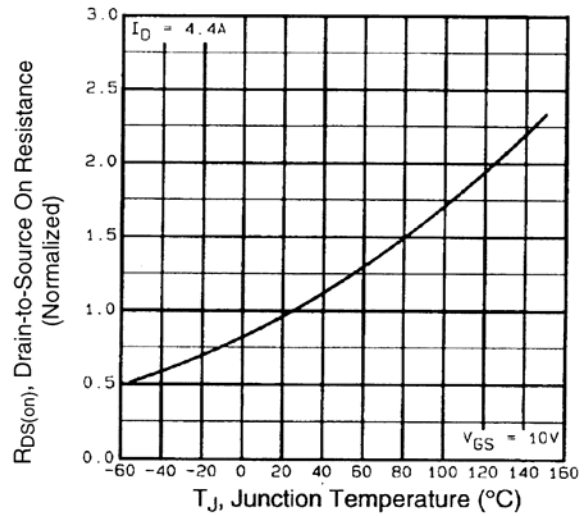

Fig 4. Normalized On-Resistance
Vs. Temperature

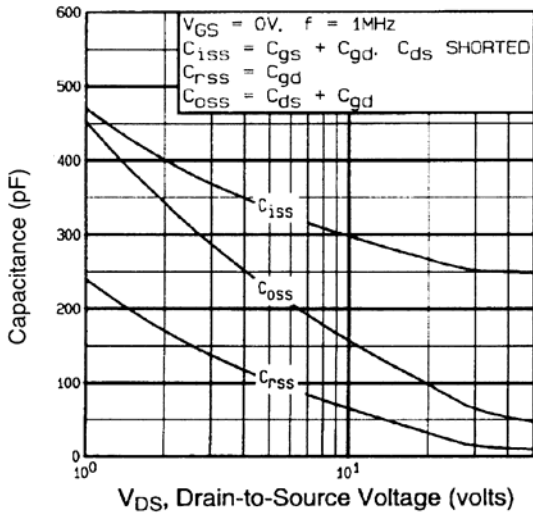

Fig 5. Typical Capacitance Vs. Drain-to-Source Voltage

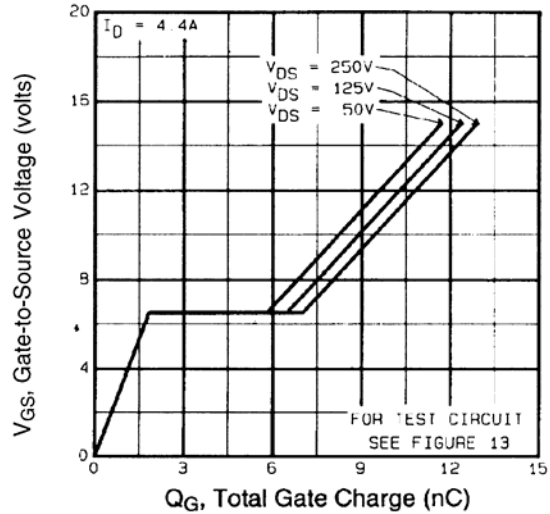

Fig 6. Typical Gate Charge Vs. Gate-to-Source Voltage

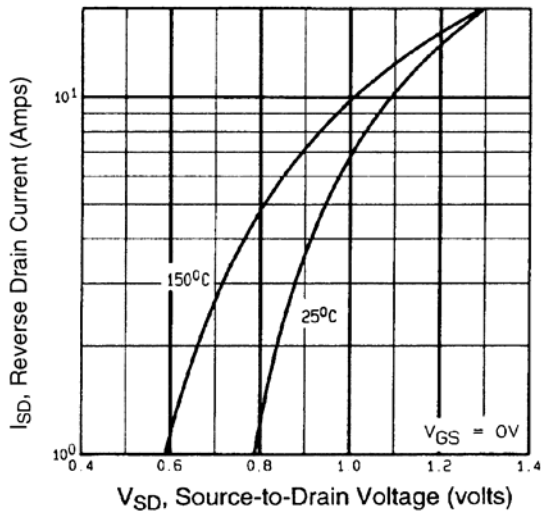

Fig 7. Typical Source-Drain Diode Forward Voltage

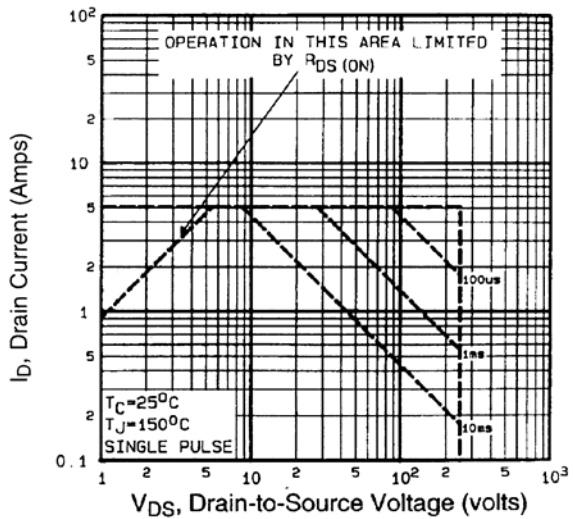

Fig 8. Maximum Safe Operating Area

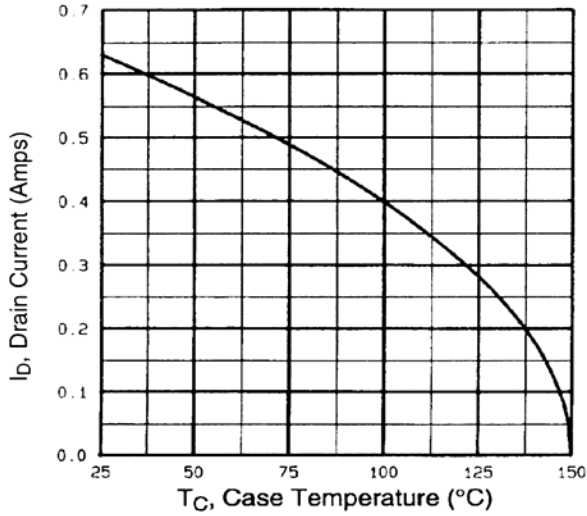

Fig 9. Maximum Drain Current Vs. Case Temperature

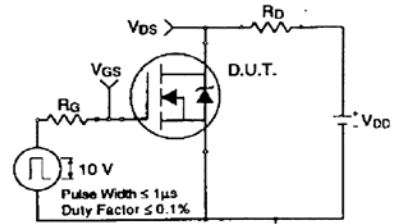

Fig 10a. Switching Time Test Circuit

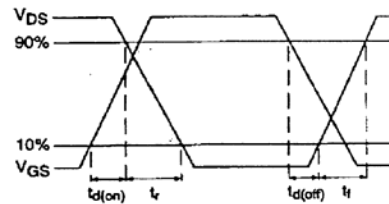

Fig 10b. Switching Time Waveforms

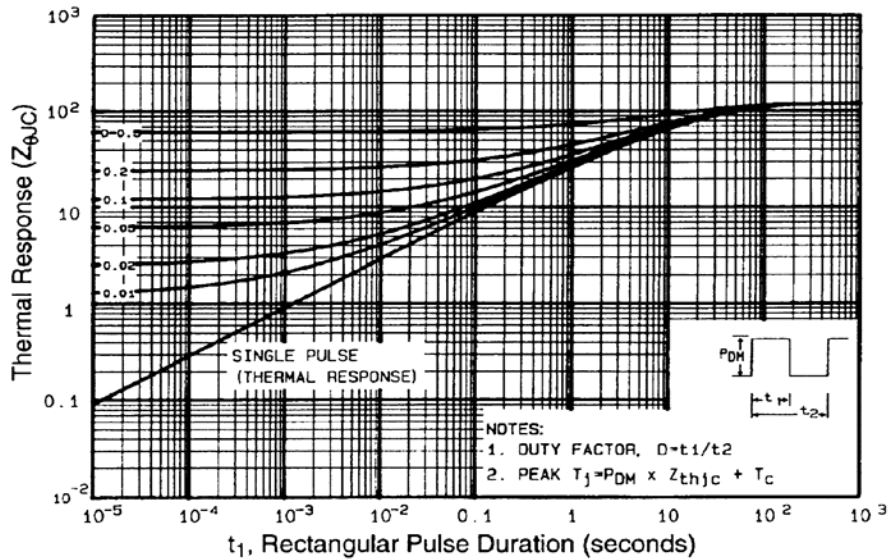

Fig 11. Maximum Effective Transient Thermal Impedance, Junction-to-Case

IRFD224PbF

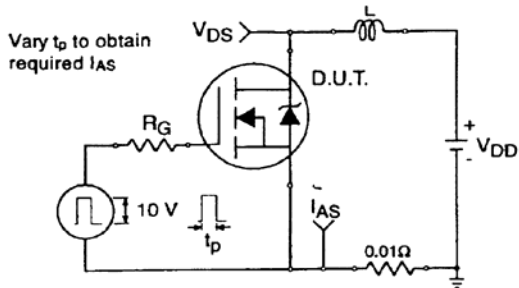

Fig 12a. Unclamped Inductive Test Circuit

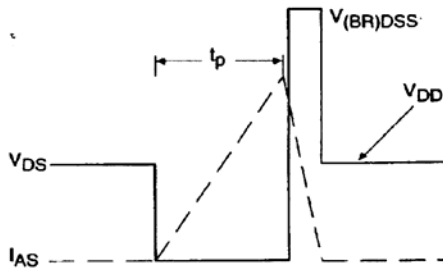

Fig 12b. Unclamped Inductive Waveforms

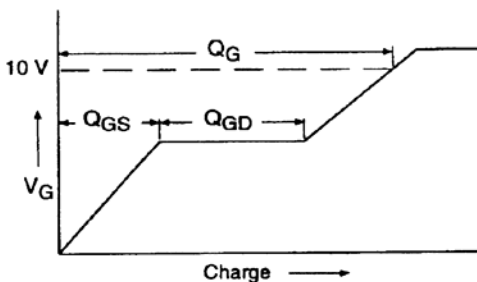

Fig 13a. Basic Gate Charge Waveform

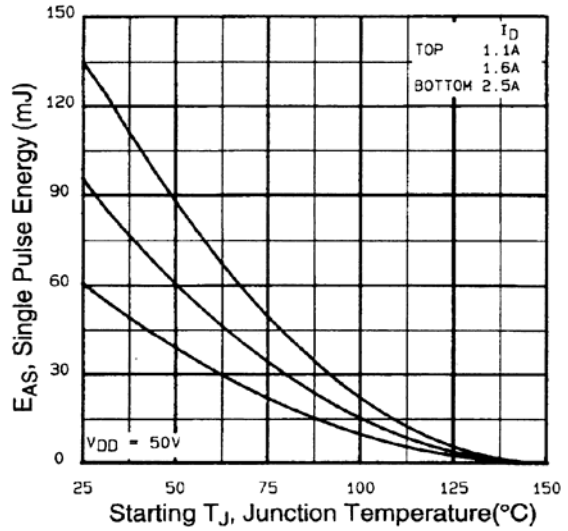

Fig 12c. Maximum Avalanche Energy Vs. Drain Current

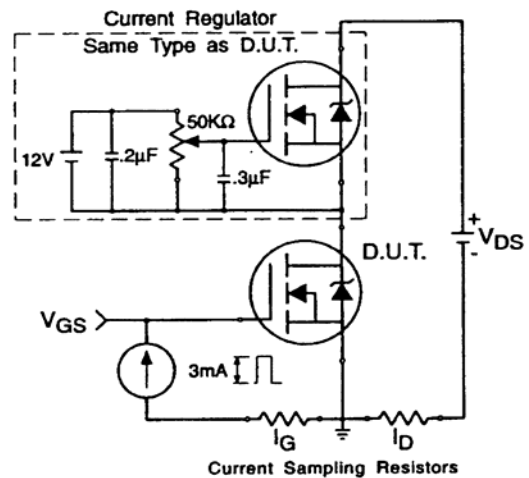
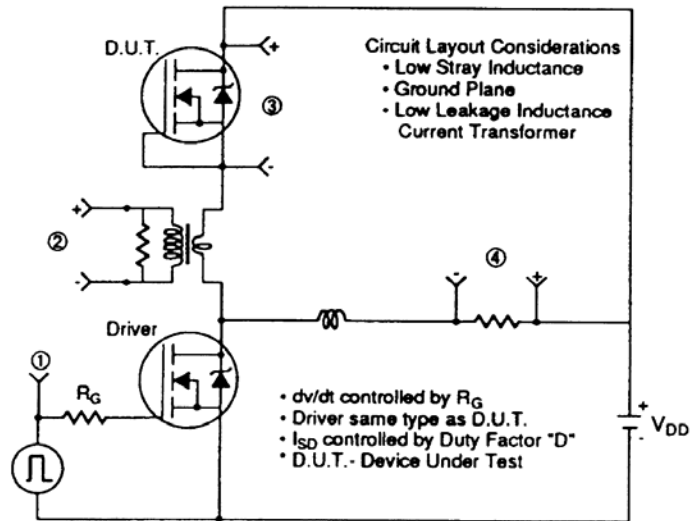

Fig 13b. Gate Charge Test Circuit

dv/dt Test Circuit

Fig 14. For N-Channel HEXFETs



Peak Diode Recovery Test Circuit

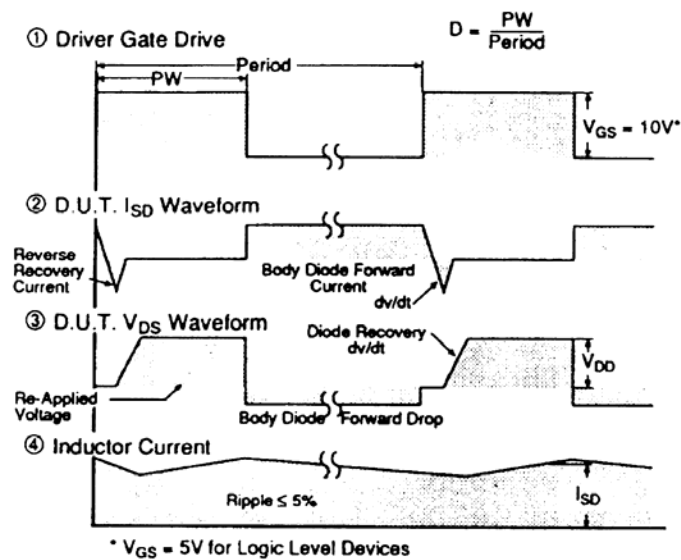

IRFD224PbF

International
IR Rectifier

Hexdip Package Outline

Dimensions are shown in millimeters (inches)



NOTES:

- ① APPLIES TO SPREAD OF LEADS PRIOR TO INSTALLATION
- ② APPLIES TO INSTALLED LEAD CENTERS
- 3 CONTROLLING DIMENSION: INCH.
- 4 DIMENSIONS ARE SHOWN MILLIMETERS (INCHES).
- 5 CASE STYLE HD-1 (SIMILAR TO JEDEC OUTLINE MO-001AN)
- 6 DIMENSIONS SHOWN ARE BEFORE SOLDER DIP
SOLDER DIP MAX. + 0.16 (0.006)

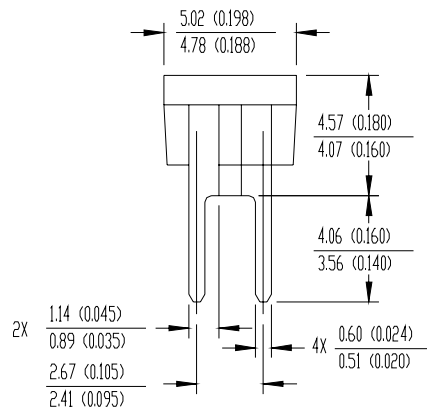
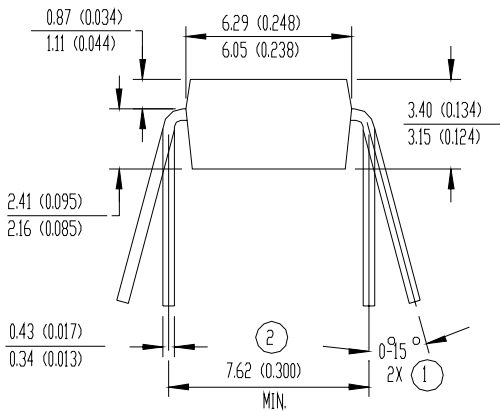

Hexdip Part Marking Information

EXAMPLE: THIS IS AN IRFD120

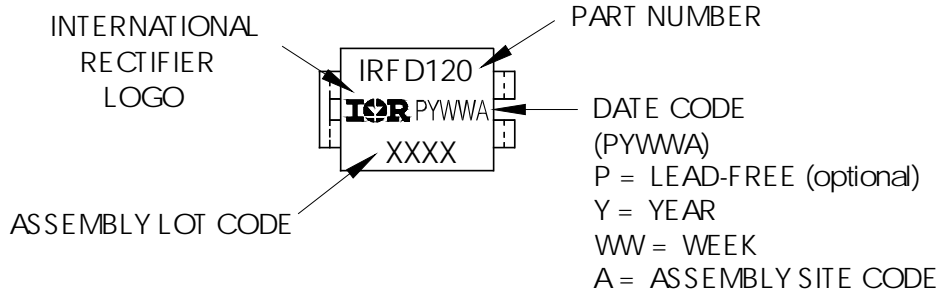

Data and specifications subject to change without notice.

International
IR Rectifier

IR WORLD HEADQUARTERS: 233 Kansas St., El Segundo, California 90245, USA Tel: (310) 252-7105
TAC Fax: (310) 252-7903

Visit us at www.irf.com for sales contact information. 10/04

www.irf.com