

HFB20HJ20C

Ultrafast, Soft Recovery Diode

Features

- Reduced RFI and EMI
- Reduced Snubbing
- Extensive Characterization of Recovery Parameters
- Hermetic
- Surface Mount

$V_R = 200V$
$I_{F(AV)} = 20A$
$t_{rr} = 20ns$

Description

HEXFRED™ diodes are optimized to reduce losses and EMI/RFI in high frequency power conditioning systems. An extensive characterization of the recovery behavior for different values of current, temperature and di/dt simplifies the calculations of losses in the operating conditions. The softness of the recovery eliminates the need for a snubber in most applications. These devices are ideally suited for power converters, motors drives and other applications where switching losses are significant portion of the total losses.

Absolute Maximum Ratings

	Parameter	Max.	Units
V_R	Cathode to Anode Voltage (Per Leg)	200	V
$I_{F(AV)}$	Continuous Forward Current, ① $T_C = 85^\circ C$	20	A
I_{FSM}	Single Pulse Forward Current, ② $T_C = 25^\circ C$ (Per Leg)	125	
$P_D @ T_C = 25^\circ C$	Maximum Power Dissipation	28	W
T_J, T_{STG}	Operating Junction and Storage Temperature Range	-55 to +150	$^\circ C$

Note: ① D.C. = 50% rect. wave
 ② 1/2 sine wave, 60 Hz , P.W. = 8.33 ms

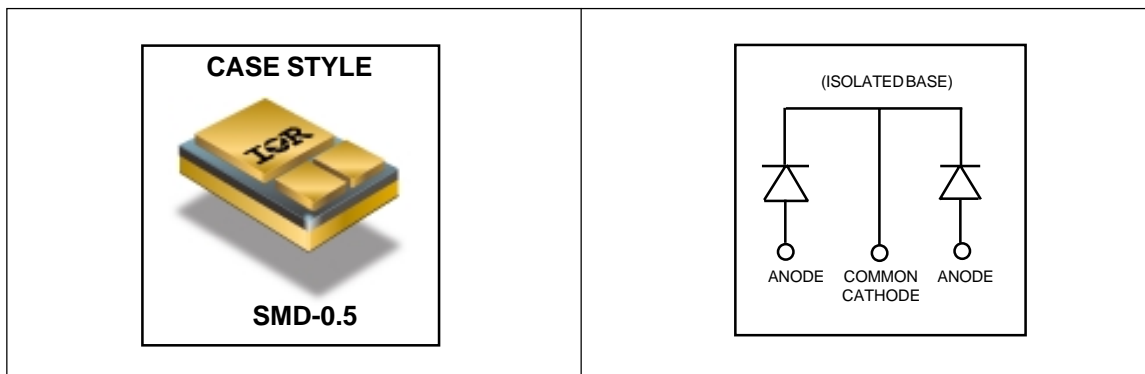

Electrical Characteristics (Per Leg) @ T_J = 25°C (unless otherwise specified)

	Parameter	Min.	Typ.	Max.	Units	Test Conditions
V _{BR}	Cathode Anode Breakdown Voltage	200	—	—	V	I _R = 100μA
V _F	Forward Voltage See Fig. 1	—	—	1.26	V	I _F = 10A, T _J = -55°C
		—	—	1.11		I _F = 10A, T _J = 25°C
		—	—	1.30		I _F = 20A, T _J = 25°C
		—	—	0.96		I _F = 10A, T _J = 125°C
I _R	Reverse Leakage Current See Fig. 2	—	—	10	μA	V _R = V _R Rated
		—	—	1.0	mA	V _R = V _R Rated, T _J = 125°C
C _T	Junction Capacitance, See Fig. 3	—	—	20	pF	V _R = 200V
L _S	Series Inductance	—	4.8	—	nH	Measured from center of cathode pad to center of anode pad

Dynamic Recovery Characteristics (Per Leg) @ T_J = 25°C (unless otherwise specified)

	Parameter	Min.	Typ.	Max.	Units	Test Conditions
t _{rr}	Reverse Recovery Time	—	—	20	ns	I _F = 1.0A, V _R = 30V, di _F /dt = 200A/μs
t _{rr1}	Reverse Recovery Time	—	27	—	ns	T _J = 25°C See Fig. 5
t _{rr2}		—	42	—		T _J = 125°C
I _{RRM1}	Peak Recovery Current	—	3.5	—	A	T _J = 25°C See Fig. 6
I _{RRM2}		—	5.5	—		T _J = 125°C
Q _{rr1}	Reverse Recovery Charge	—	54	—	nC	T _J = 25°C See Fig. 7
Q _{rr2}		—	120	—		T _J = 125°C
di _{(rec)M} /dt1	Peak Rate of Fall of Recovery Current During t _b	—	640	—	A/μs	T _J = 25°C See Fig. 8
di _{(rec)M} /dt2		—	850	—		T _J = 125°C

Thermal - Mechanical Characteristics

	Parameter	Typ.	Max.	Units
R _{thJC}	Junction-to-Case, Single Leg Conducting	—	4.5	°C/W
Wt	Weight	1.0	—	g

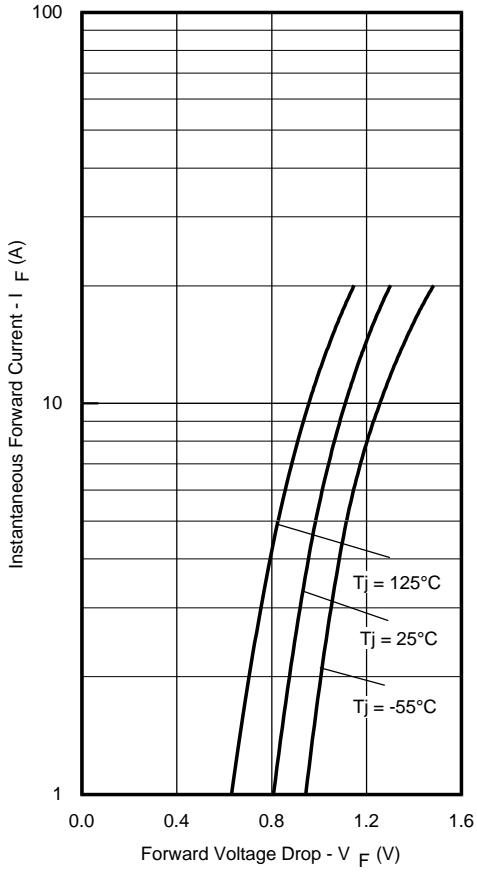

Fig. 1 - Maximum Forward Voltage Drop Vs. Instantaneous Forward Current (Per Leg)

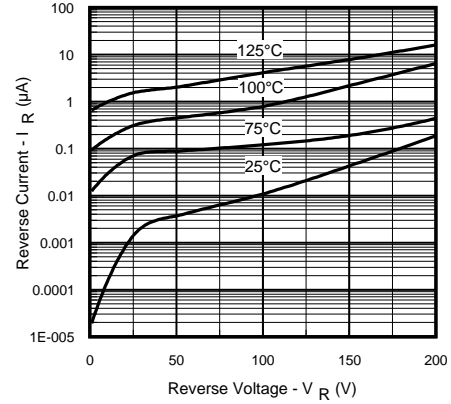

Fig. 2 - Typical Reverse Current Vs. Reverse Voltage (Per Leg)

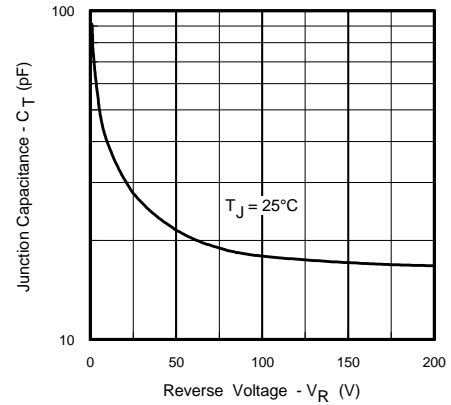

Fig. 3 - Typical Junction Capacitance Vs. Reverse Voltage (Per Leg)

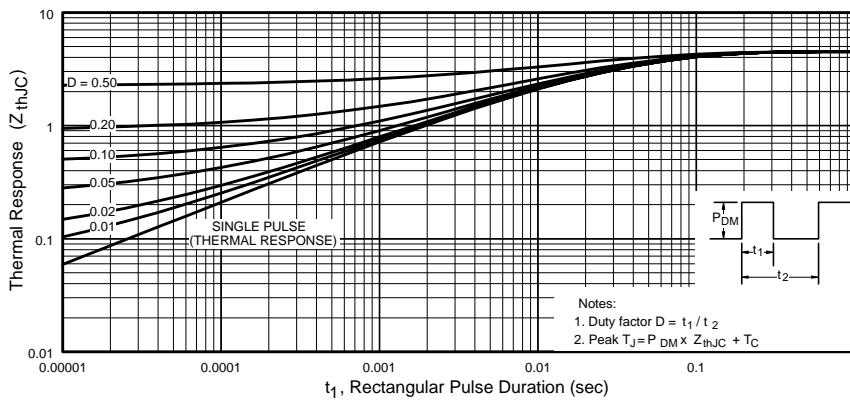

Fig. 4 - Maximum Thermal Impedance Z_{thJC} Characteristics (Per Leg)

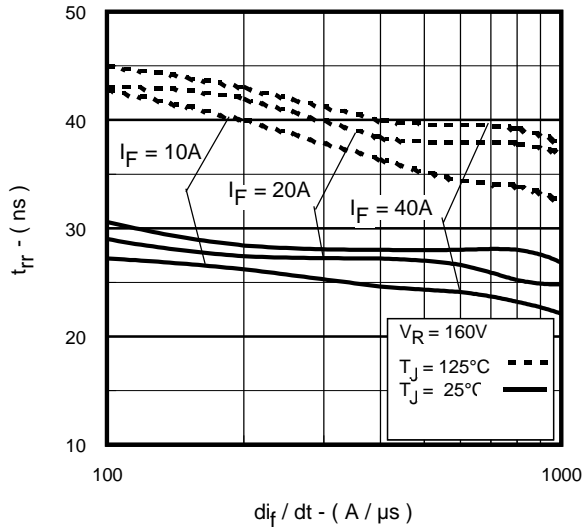

Fig. 5 - Typical Reverse Recovery Vs. di/dt , (Per Leg)

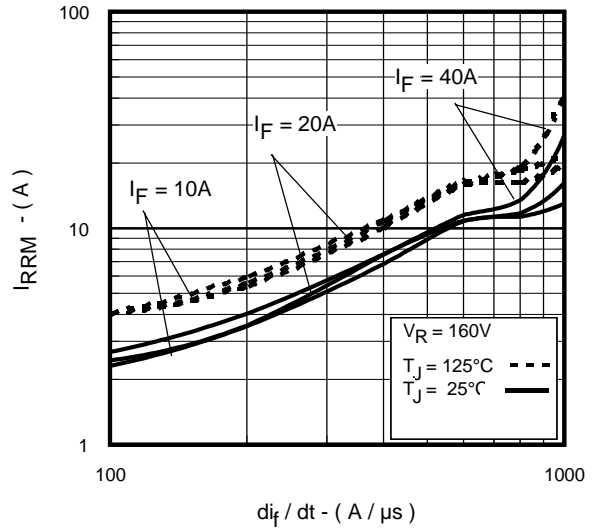

Fig. 6 - Typical Recovery Current Vs. di/dt (Per Leg)

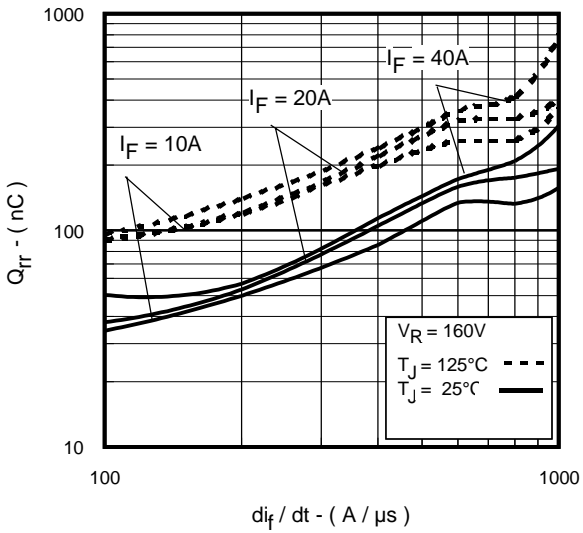

Fig. 7 - Typical Stored Charge Vs. di/dt (Per Leg)

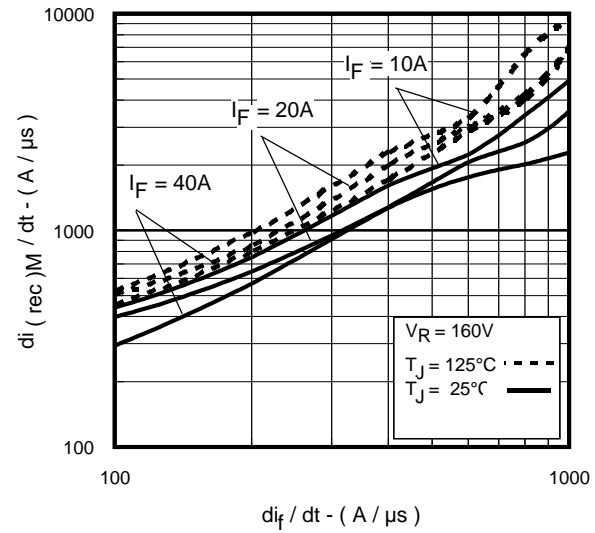
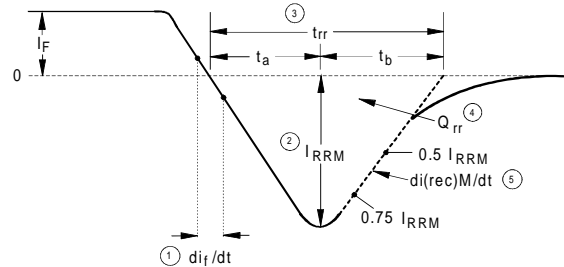
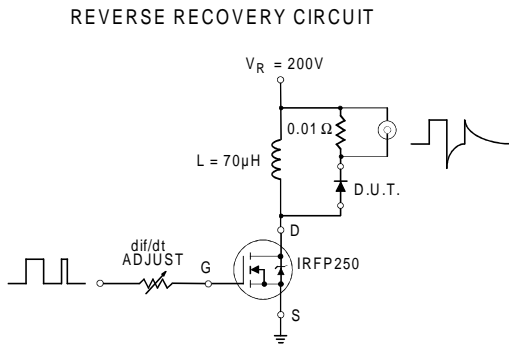

Fig. 8 - Typical $di_{(rec)M}/dt$ Vs. di/dt (Per Leg)



1. di/dt - Rate of change of current through zero crossing
 2. I_{RRM} - Peak reverse recovery current
 3. t_{rr} - Reverse recovery time measured from zero crossing point of negative going I_F to point where a line passing through $0.75 I_{RRM}$ and $0.5 I_{RRM}$ extrapolated to zero current
 4. Q_{rr} - Area under curve defined by t_{rr} and I_{RRM}
 5. $di_{(rec)M}/dt$ - Peak rate of change of current during t_b portion of t_{rr}
- $$Q_{rr} = \frac{t_{rr} \times I_{RRM}}{2}$$

Fig. 9 - Reverse Recovery Parameter Test Circuit

Fig. 10 - Reverse Recovery Waveform and Definitions

Case Outline and Dimensions — SMD-0.5

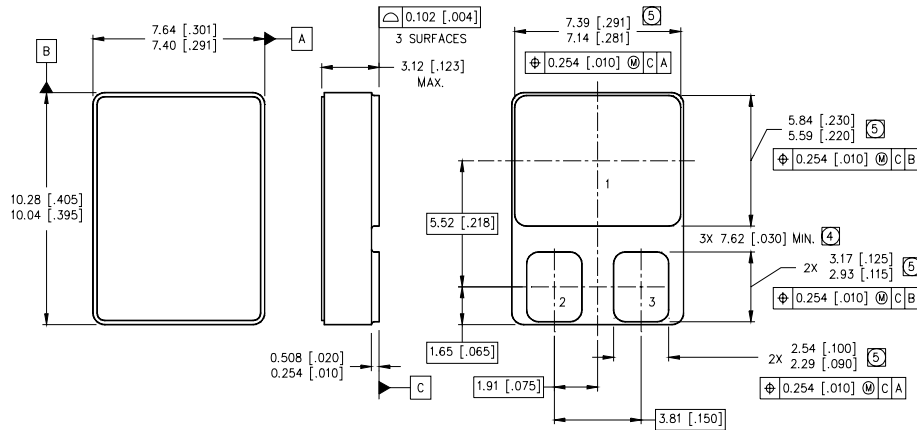

NOTES:

1. DIMENSIONING & TOLERANCING PER ASME Y14.5M-1994.
2. CONTROLLING DIMENSION: INCH.
3. DIMENSIONS ARE SHOWN IN MILLIMETERS [INCHES].
- ④ DIMENSION INCLUDES METALLIZATION FLASH.
- ⑤ DIMENSION DOES NOT INCLUDE METALLIZATION FLASH.

PAD ASSIGNMENTS

- HEXFRED DOUBLE DIE
- 1 = COMMON CATHODE
- 2 = ANODE 1
- 3 = ANODE 2