

Features

- Reduced RFI and EMI
- Reduced Snubbing
- Extensive Characterization of Recovery Parameters
- Hermetic
- Ceramic Eyelets

$V_R = 1200V$
$I_{F(AV)} = 15A$
$Q_{rr} = 370ns$

Description

These Ultrafast, soft recovery diodes are optimized to reduce losses and EMI/RFI in high frequency power conditioning systems. An extensive characterization of the recovery behavior for different values of current, temperature and di/dt simplifies the calculations of losses in the operating conditions. The softness of the recovery eliminates the need for a snubber in most applications. These devices are ideally suited for power converters, motors drives and other applications where switching losses are significant portion of the total losses.

Absolute Maximum Ratings

	Parameter	Max.	Units
V_R	Cathode to Anode Voltage (Per Leg)	1200	V
$I_{F(AV)}$	Continuous Forward Current, ① $T_C = 100^\circ C$	15	A
I_{FSM}	Single Pulse Forward Current, ② $T_C = 25^\circ C$ (Per Leg)	80	
$P_D @ T_C = 25^\circ C$	Maximum Power Dissipation	63	W
T_J, T_{STG}	Operating Junction and Storage Temperature Range	-55 to +150	$^\circ C$

Note: ① D.C. = 50% rect. wave
 ② 1/2 sine wave, 60 Hz , PW. = 8.33 ms

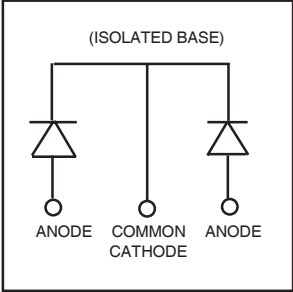
<p>CASE STYLE</p>  <p>TO-254AA</p>	<p>(ISOLATED BASE)</p>  <p>ANODE COMMON CATHODE ANODE</p>
---	---

Electrical Characteristics (Per Leg) @ $T_J = 25^\circ\text{C}$ (unless otherwise specified)

	Parameter	Min.	Typ.	Max.	Units	Test Conditions
V_{BR}	Cathode Anode Breakdown Voltage	1200	—	—	V	$I_R = 250\mu\text{A}$
V_F	Forward Voltage See Fig. 1	—	—	3.1	V	$I_F = 7.0\text{A}$, $T_J = -55^\circ\text{C}$
		—	—	3.3		$I_F = 7.0\text{A}$
		—	—	4.4		$I_F = 15\text{A}$
		—	—	2.8		$I_F = 7.0\text{A}$, $T_J = 125^\circ\text{C}$
I_R	Max Reverse Leakage Current See Fig. 2	—	—	10	μA	$V_R = V_R$ Rated
		—	—	1.0	mA	$V_R = 960\text{V}$, $T_J = 125^\circ\text{C}$
C_T	Junction Capacitance, See Fig. 3	—	10	15	pF	$V_R = 200\text{V}$
L_S	Series Inductance	—	8.7	—	nH	Measured from anode lead to cathode lead, 6mm (0.025 in) from package

Dynamic Recovery Characteristics (Per Leg) @ $T_J = 25^\circ\text{C}$ (unless otherwise specified)

	Parameter	Min.	Typ.	Max.	Units	Test Conditions
t_{rr1}	Reverse Recovery Time	—	58	100	ns	$T_J = 25^\circ\text{C}$ See Fig.
t_{rr2}		—	110	165		$T_J = 125^\circ\text{C}$ 5
I_{RRM1}	Peak Recovery Current	—	5.4	8.1	A	$T_J = 25^\circ\text{C}$ See Fig.
I_{RRM2}		—	7.2	10.8		$T_J = 125^\circ\text{C}$ 6
Q_{rr1}	Reverse Recovery Charge	—	185	370	nC	$T_J = 25^\circ\text{C}$ See Fig.
Q_{rr2}		—	395	590		$T_J = 125^\circ\text{C}$ 7
$di_{(rec)M}/dt1$	Peak Rate of Fall of Recovery Current	—	255	380	$\text{A}/\mu\text{s}$	$T_J = 25^\circ\text{C}$ See Fig.
$di_{(rec)M}/dt2$	During t_b	—	160	240		$T_J = 125^\circ\text{C}$ 8

$I_F = 7\text{A}$
 $V_R = 200\text{V}$
 $di/dt = 200\text{A}/\mu\text{s}$

Thermal - Mechanical Characteristics

	Parameter	Typ.	Max.	Units
R_{thJC}	Junction-to-Case, Single Leg Conducting	—	2.0	$^\circ\text{C}/\text{W}$
Wt	Weight	9.3	—	g

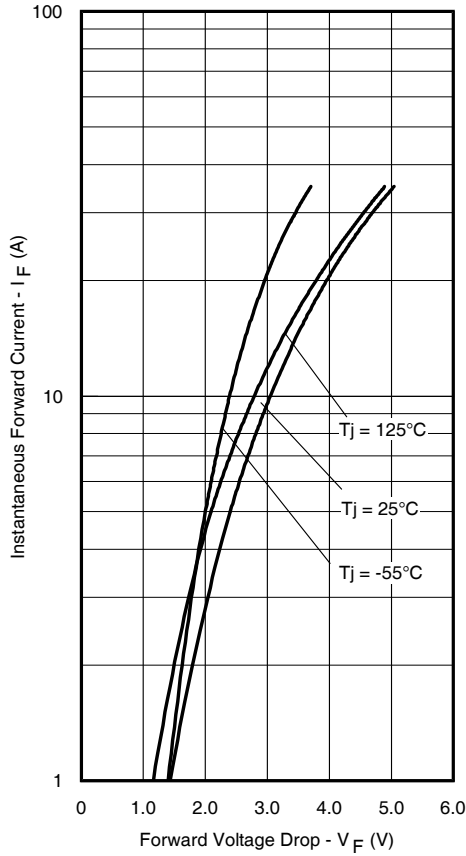

Fig. 1 - Typical Forward Voltage Drop Vs. Instantaneous Forward Current (Per Leg)

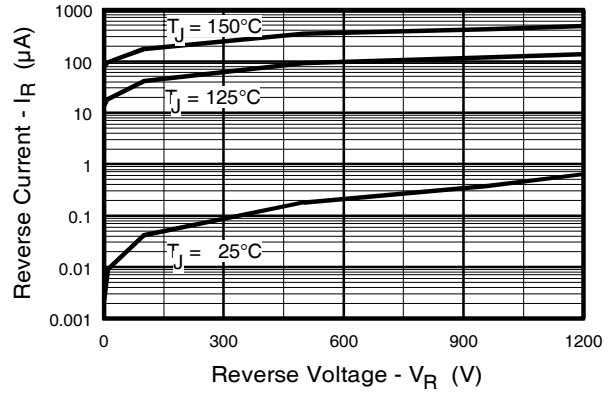

Fig. 2 - Typical Reverse Current Vs. Reverse Voltage (Per Leg)

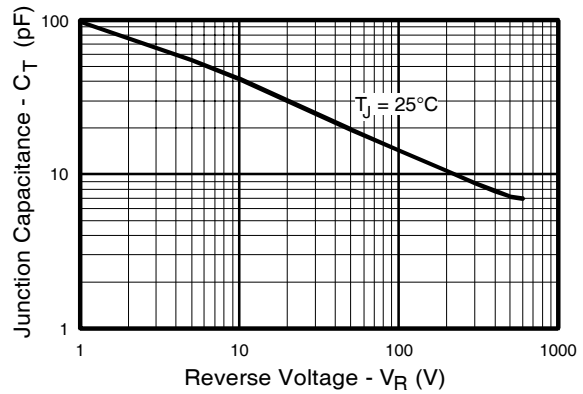

Fig. 3 - Typical Junction Capacitance Vs. Reverse Voltage (Per Leg)

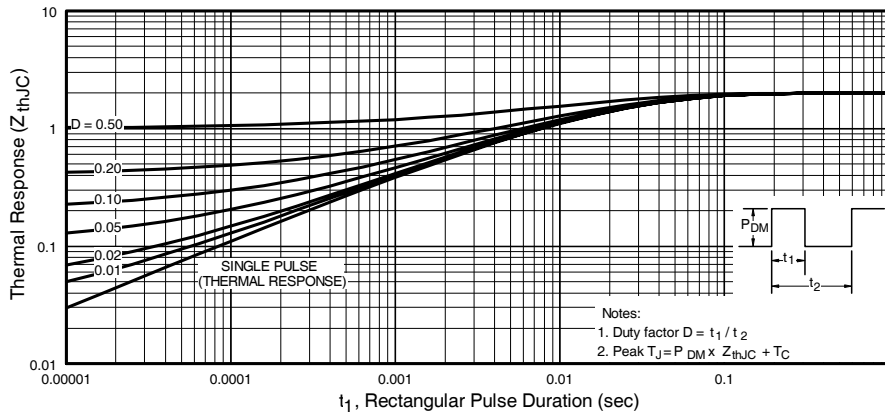

Fig. 4 - Maximum Thermal Impedance Z_{thJC} Characteristics (Per Leg)

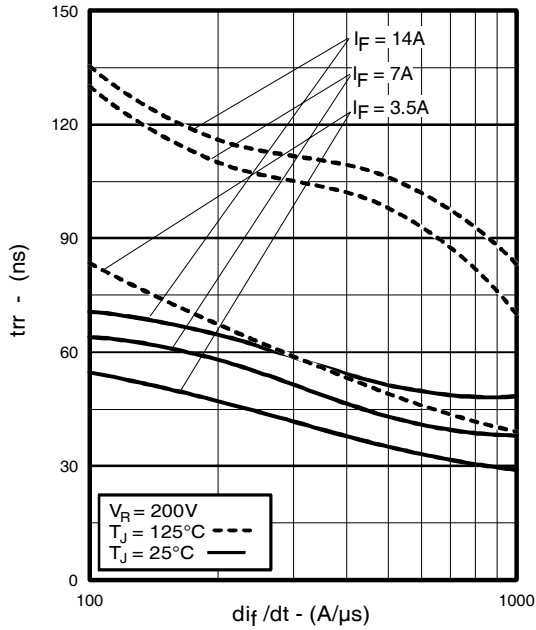

Fig. 5 - Typical Reverse Recovery vs. di_f/dt

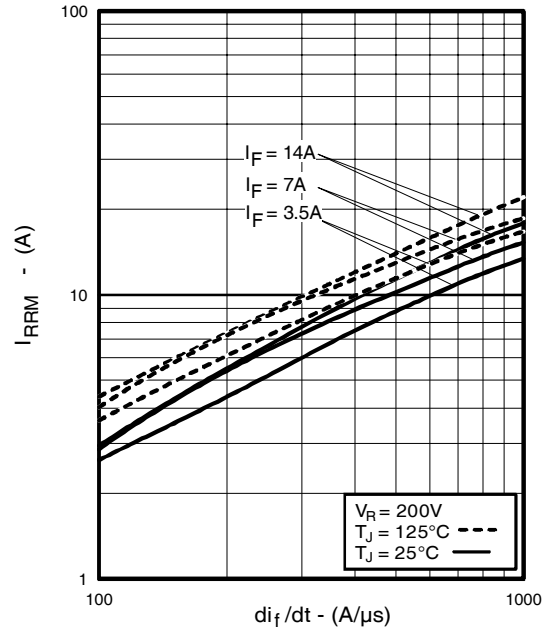

Fig. 6 - Typical Recovery Current vs. di_f/dt

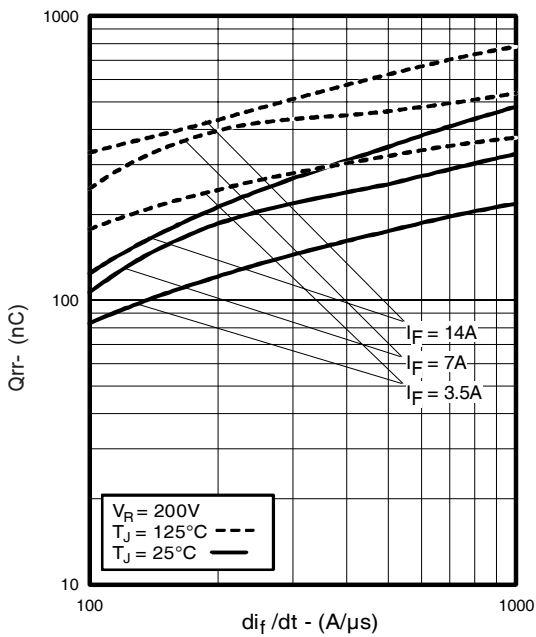

Fig. 7 - Typical Stored Charge vs. di_f/dt

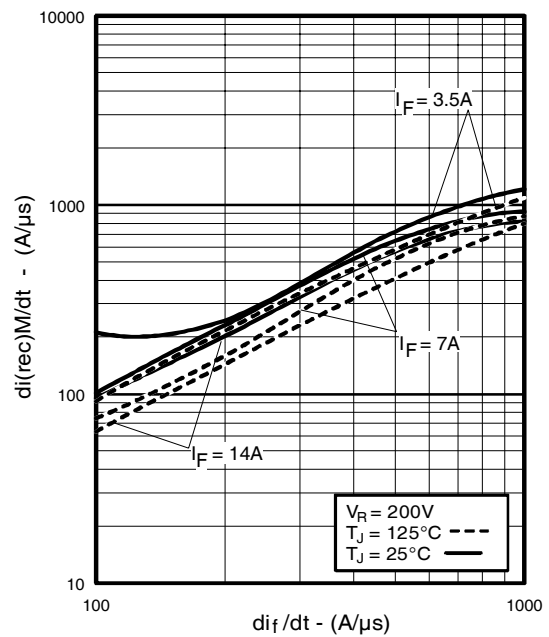

Fig. 8 - Typical $di_{(rec)M}/dt$ vs. di_f/dt

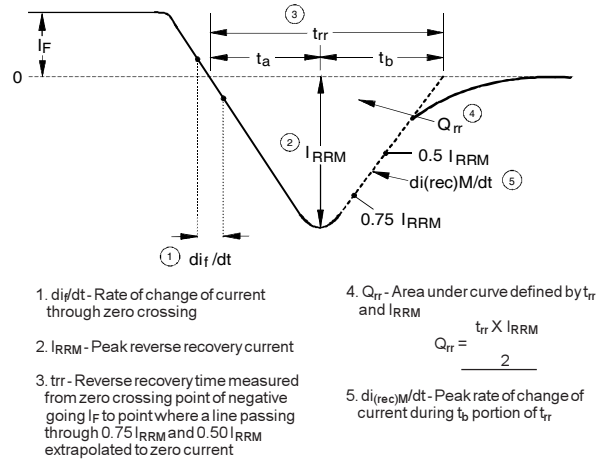
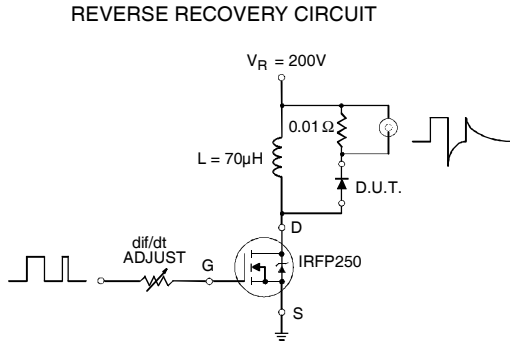
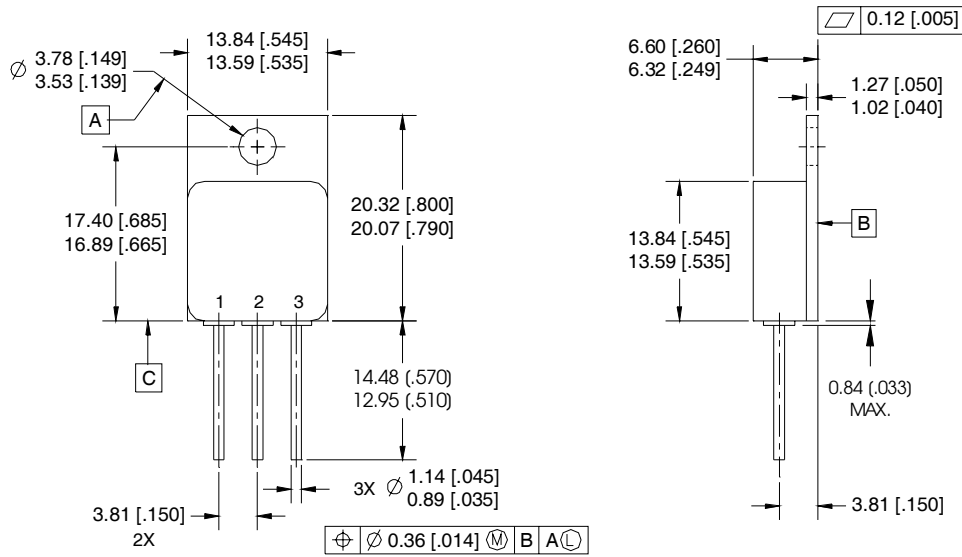

Fig. 9 - Reverse Recovery Parameter Test Circuit

Fig. 10 - Reverse Recovery Waveform and Definitions

Case Outline and Dimensions — TO-254AA



NOTES:

1. DIMENSIONING & TOLERANCING PER ASME Y14.5M-1994.
2. ALL DIMENSIONS ARE SHOWN IN MILLIMETERS (INCHES).
3. CONTROLLING DIMENSION: INCH.
4. CONFORMS TO JEDEC OUTLINE TO-254AA.

PIN ASSIGNMENTS

- 1 = ANODE 1
- 2 = COMMON CATHODE
- 3 = ANODE 2