

Features

- Ultrafast Recovery
- Ultrasoft Recovery
- Very Low I_{RRM}
- Very Low Q_{rr}
- Specified at Operating Conditions
- Lead-Free

Benefits

- Reduced RFI and EMI
- Reduced Power Loss in Diode and Switching Transistor
- Higher Frequency Operation
- Reduced Snubbing
- Reduced Parts Count

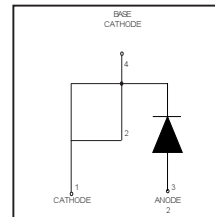

$V_R = 1200V$
V_F (typ.)* = 2.4V
I_F (AV) = 8.0A
Q_{rr} (typ.) = 140nC
I_{RRM} (typ.) = 4.5A
t_{rr} (typ.) = 28ns
$di_{(rec)M}/dt$ (typ.)* = 85A/μs

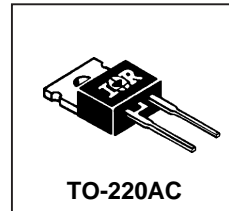

Description

International Rectifier's HFA08TB120 is a state of the art ultra fast recovery diode. Employing the latest in epitaxial construction and advanced processing techniques it features a superb combination of characteristics which result in performance which is unsurpassed by any rectifier previously available. With basic ratings of 1200 volts and 8 amps continuous current, the HFA08TB120 is especially well suited for use as the companion diode for IGBTs and MOSFETs. In addition to ultra fast recovery time, the HEXFRED product line features extremely low values of peak recovery current (I_{RRM}) and does not exhibit any tendency to "snap-off" during the t_b portion of recovery. The HEXFRED features combine to offer designers a rectifier with lower noise and significantly lower switching losses in both the diode and the switching transistor. These HEXFRED advantages can help to significantly reduce snubbing, component count and heatsink sizes. The HEXFRED HFA08TB120 is ideally suited for applications in power supplies and power conversion systems (such as inverters), motor drives, and many other similar applications where high speed, high efficiency is needed.

Absolute Maximum Ratings

	Parameter	Max	Units
V_R	Cathode-to-Anode Voltage	1200	V
$I_F @ T_C = 100^\circ C$	Continuous Forward Current	8.0	A
I_{FSM}	Single Pulse Forward Current	130	
I_{FRM}	Maximum Repetitive Forward Current	32	
$P_D @ T_C = 25^\circ C$	Maximum Power Dissipation	73.5	W
$P_D @ T_C = 100^\circ C$	Maximum Power Dissipation	29	
T_J	Operating Junction and	- 55 to 150	°C
T_{STG}	Storage Temperature Range		

*125°C

HFA08TB120PbF

International

Electrical Characteristics @ $T_J = 25^\circ\text{C}$ (unless otherwise specified) Rectifier

Parameter	Min	Typ	Max	Units	Test Conditions
V_{BR} Cathode Anode Breakdown Voltage	1200	-	-	V	$I_R = 100\mu\text{A}$
V_{FM} Max. Forward Voltage	-	2.6	3.3	V	$I_F = 8.0\text{A}$
	-	3.4	4.3		$I_F = 16\text{A}$
	-	2.4	3.1		$I_F = 8.0\text{A}, T_J = 125^\circ\text{C}$
I_{RM} Max. Reverse Leakage Current	-	0.31	10	μA	$V_R = V_R$ Rated
	-	135	1000		$T_J = 125^\circ\text{C}, V_R = 0.8 \times V_R$ Rated
C_T Junction Capacitance	-	11	20	pF	$V_R = 200\text{V}$
L_S Series Inductance	-	8.0	-	nH	Measured lead to lead 5mm from pkg body

Dynamic Recovery Characteristics @ $T_J = 25^\circ\text{C}$ (unless otherwise specified)

Parameter	Min	Typ	Max	Units	Test Conditions
t_{rr} Reverse Recovery Time	-	28	-	ns	$I_F = 1.0\text{A}, di_f/dt = 200\text{A}/\mu\text{s}, V_R = 30\text{V}$
t_{rr1}	-	63	95	ns	$T_J = 25^\circ\text{C}$
t_{rr2}	-	106	160		$T_J = 125^\circ\text{C}$
I_{RRM1} Peak Recovery Current	-	4.5	8.0		A
	-	6.2	11	$T_J = 125^\circ\text{C}$	
Q_{rr1} Reverse Recovery Charge	-	140	380	nC	$T_J = 25^\circ\text{C}$
	-	335	880		$T_J = 125^\circ\text{C}$
$di_{(rec)M}/dt1$ Peak Rate of Recovery	-	133	-	A/ μs	$T_J = 25^\circ\text{C}$
$di_{(rec)M}/dt2$ Current During t_b	-	85	-		$T_J = 125^\circ\text{C}$

Thermal - Mechanical Characteristics

Parameter	Min	Typ	Max	Units
$T_{lead} \text{①}$ Lead Temperature	-	-	300	$^\circ\text{C}$
R_{thJC} Thermal Resistance, Junction to Case	-	-	1.7	k/W
$R_{thJA} \text{②}$ Thermal Resistance, Junction to Ambient	-	-	40	
$R_{thCS} \text{③}$ Thermal Resistance, Case to Heat Sink	-	0.25	-	
Wt Weight	-	6.0	-	g
	-	0.21	-	(oz)
Mounting Torque	6.0	-	12	Kg-cm
	5.0	-	10	lbf-in

① 0.063 in. from Case (1.6mm) for 10 sec

② Typical Socket Mount

③ Mounting Surface, Flat, Smooth and Greased

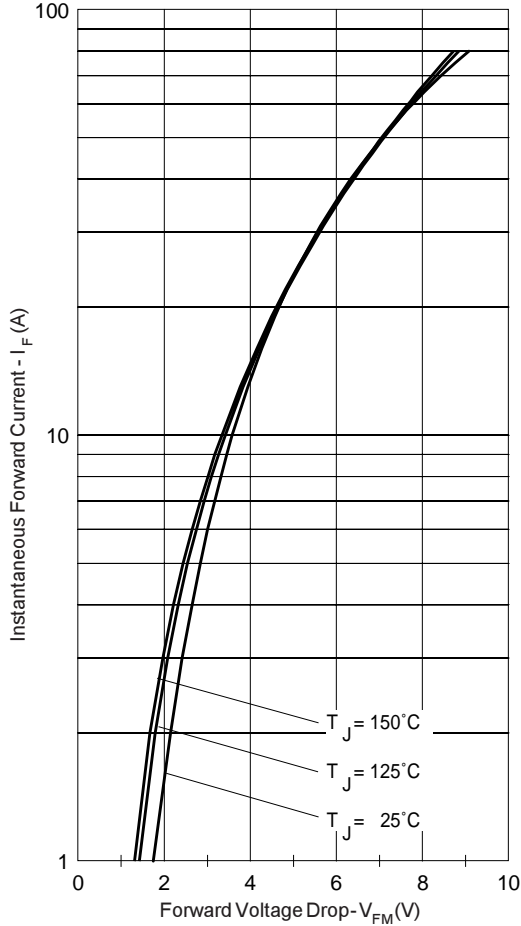

Fig. 1 - Max. Forward Voltage Drop Characteristics

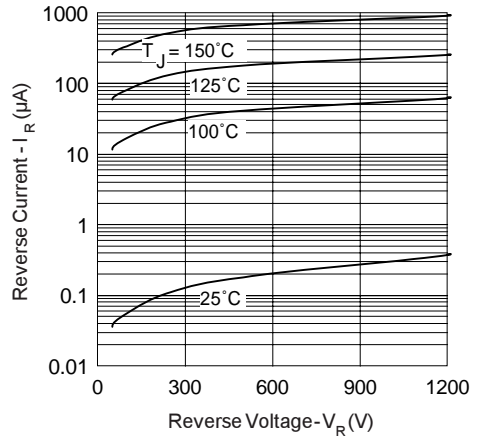

Fig. 2 - Typ. Values Of Reverse Current Vs. Reverse Voltage

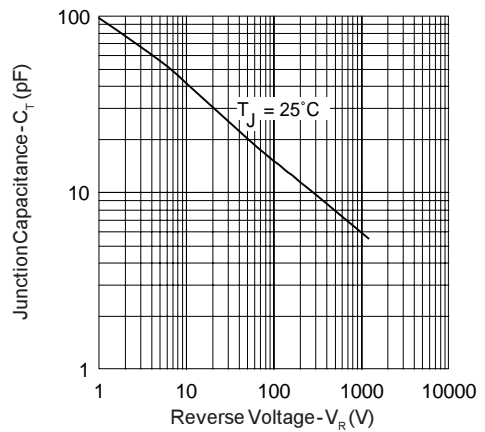

Fig. 3 - Typical Junction Capacitance Vs. Reverse Voltage

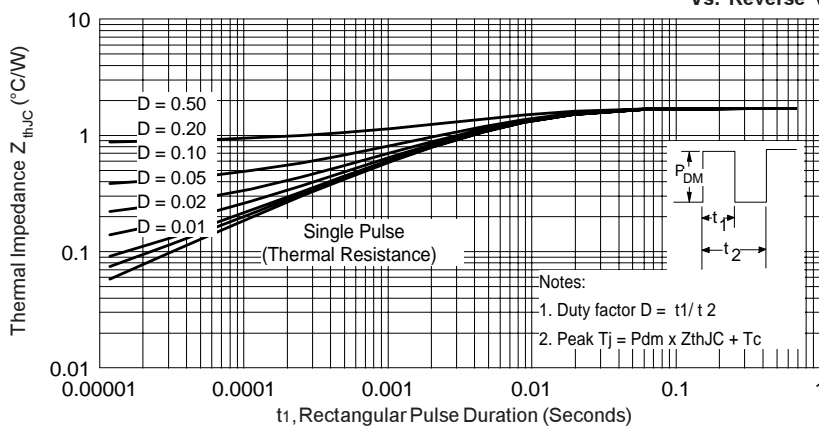

Fig. 4 - Max. Thermal Impedance Z_{thJC} Characteristics

HFA08TB120PbF

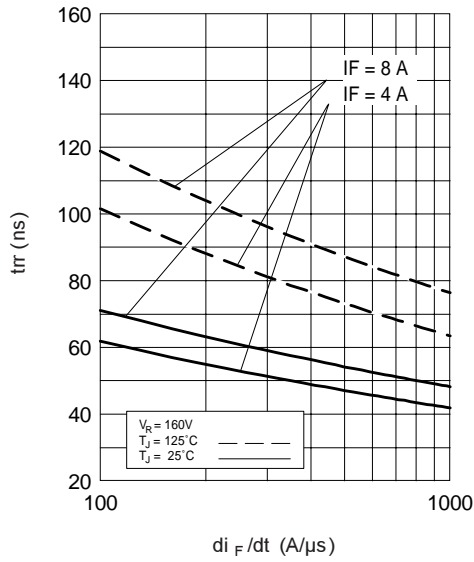

Fig. 5 - Typical Reverse Recovery Vs. di_f/dt

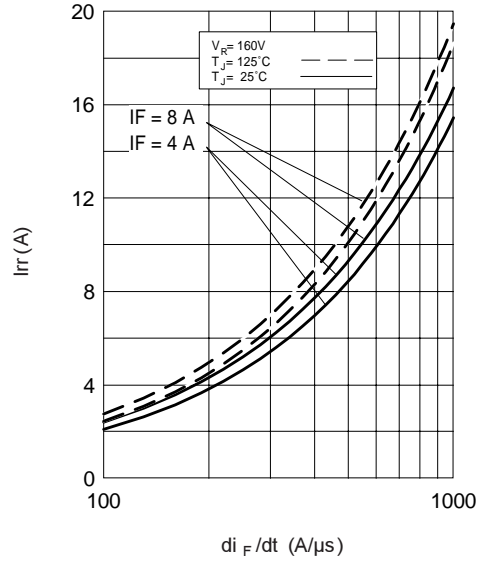

Fig. 6 - Typical Recovery Current Vs. di_f/dt

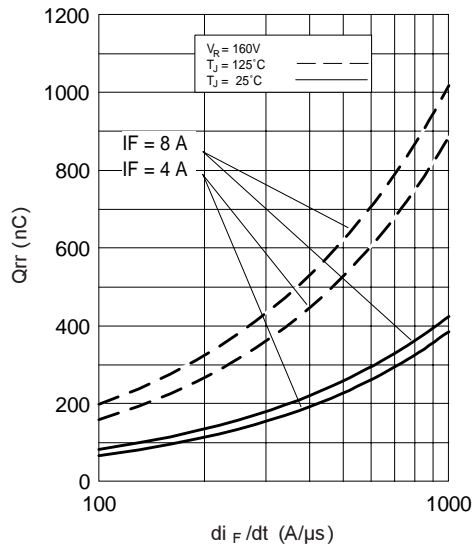

Fig. 8 - Typical Stored Charge vs. di_f/dt

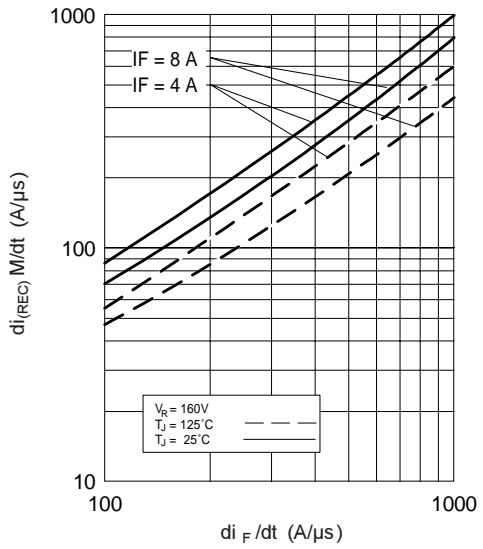

Fig. 7 - Typical $di_{(REC)}$ M/dt vs. di_f/dt

Reverse Recovery Circuit

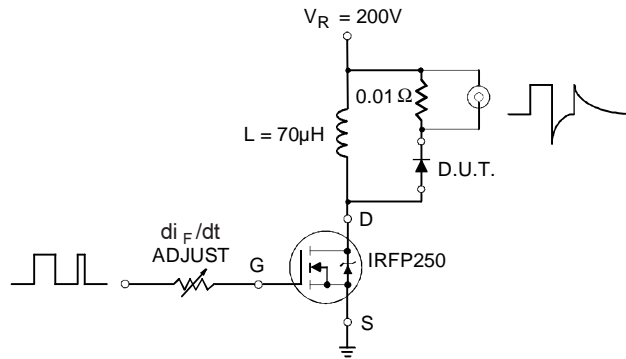
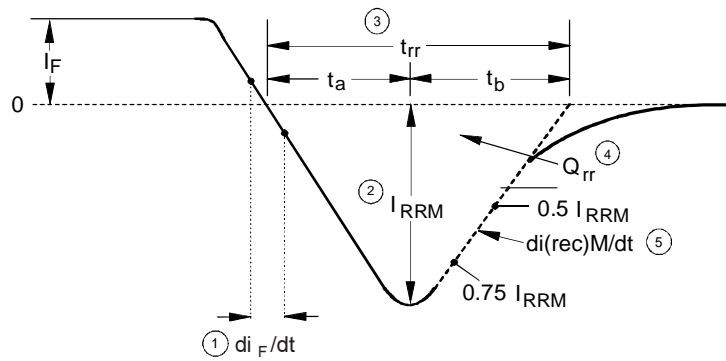

Fig. 9- Reverse Recovery Parameter Test Circuit



- | | |
|--|---|
| 1. di_F/dt - Rate of change of current through zero crossing | 4. Q_{rr} - Area under curve defined by t_{rr} and I_{RRM} |
| 2. I_{RRM} - Peak reverse recovery current | $Q_{rr} = \frac{t_{rr} \times I_{RRM}}{2}$ |
| 3. t_{rr} - Reverse recovery time measured from zero crossing point of negative going I_F to point where a line passing through $0.75 I_{RRM}$ and $0.50 I_{RRM}$ extrapolated to zero current | 5. $di_{(rec)M}/dt$ - Peak rate of change of current during t_b portion of t_{rr} |

Fig. 10 - Reverse Recovery Waveform and Definitions

HFA08TB120PbF



TO-220AC Package Outline

Dimensions are shown in millimeters (inches)

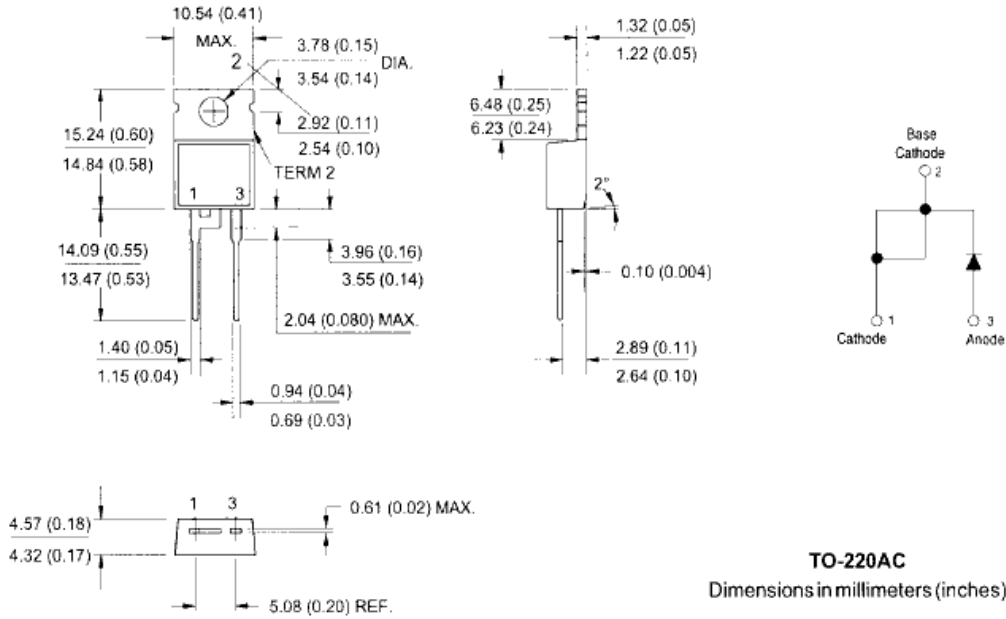

TO-220AC Part Marking Information

EXAMPLE: THIS IS AHFA06TB120
LOT CODE 1789
ASSEMBLED ON WW 19, 2001
IN THE ASSEMBLY LINE "C"

Note: "P" in the beginning of date code indicates "Lead-Free"

OR

EXAMPLE: THIS IS AHFA06TB120
LOT CODE 1789
ASSEMBLED ON WW 19, 2001
IN THE ASSEMBLY LINE "C"

Note: "P" in assembly line position indicates "Lead-Free"

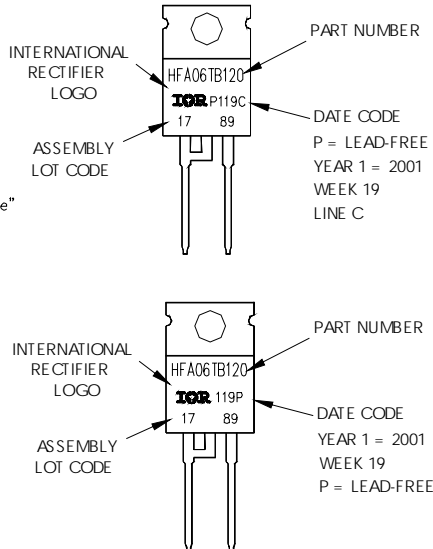

Ordering Information Table

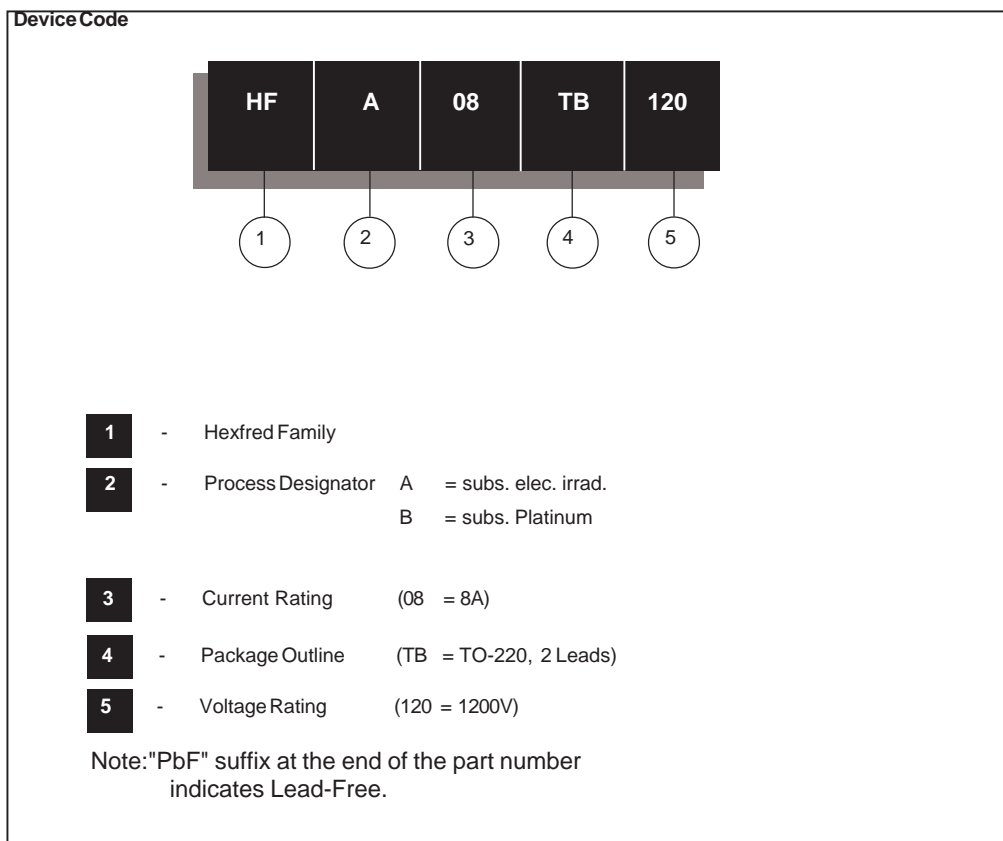

Data and specifications subject to change without notice.