

International IOR Rectifier HEXFET® POWER MOSFET

Provisional Data Sheet No. PD 9.1289B

IRFY240CM

N-CHANNEL

200 Volt, 0.18Ω HEXFET

HEXFET technology is the key to International Rectifier's advanced line of power MOSFET transistors. The efficient geometry design achieves very low on-state resistance combined with high transconductance.

HEXFET transistors also feature all of the well-established advantages of MOSFETs, such as voltage control, very fast switching, ease of paralleling and electrical parameter temperature stability. They are well-suited for applications such as switching power supplies, motor controls, inverters, choppers, audio amplifiers, high energy pulse circuits, and virtually any application where high reliability is required.

The HEXFET transistor's totally isolated package eliminates the need for additional isolating material between the device and the heatsink. This improves thermal efficiency and reduces drain capacitance.

Product Summary

| Part Number | BV _{DSS} | R _{DS(on)} | I _D |
|-------------|-------------------|---------------------|----------------|
| IRFY240CM | 200V | 0.18Ω | 16A |

Features

- Hermetically Sealed
- Electrically Isolated
- Simple Drive Requirements
- Ease of Paralleling
- Ceramic Eyelets

Absolute Maximum Ratings

| | Parameter | IRFY240CM | Units |
|---|---------------------------------|---|-------|
| I _D @ V _{GS} =10V, T _C = 25°C | Continuous Drain Current | 16 | A |
| I _D @ V _{GS} =10V, T _C = 100°C | Continuous Drain Current | 10.2 | |
| I _{DM} | Pulsed Drain Current ① | 64 | |
| P _D @ T _C = 25°C | Max. Power Dissipation | 100 | W |
| | Linear Derating Factor | 0.8 | W/K ⑤ |
| V _{GS} | Gate-to-Source Voltage | ±20 | V |
| E _{AS} | Single Pulse Avalanche Energy ② | 580 | mJ |
| I _{AR} | Avalanche Current ① | 16 | A |
| E _{AR} | Repetitive Avalanche Energy ① | 10 | mJ |
| dv/dt | Peak Diode Recovery dv/dt ③ | 5 | V/ns |
| T _J | Operating Junction | -55 to 150 | °C |
| T _{stg} | Storage Temperature Range | | |
| | Lead Temperature | 300 (0.063 in (1.6mm) from case for 10 sec) | |
| | Weight | 4.3 (typical) | g |

IRFY240CM Device

Electrical Characteristics @ T_J = 25°C (Unless Otherwise Specified)

| | Parameter | Min. | Typ. | Max. | Units | Test Conditions |
|-------------------------------------|--|------|------|------|-------|--|
| BV _{DSS} | Drain-to-Source Breakdown Voltage | 200 | — | — | V | V _{GS} = 0V, I _D = 1.0mA |
| ΔBV _{DSS} /ΔT _J | Temperature Coefficient of Breakdown Voltage | — | 0.29 | — | V/°C | Reference to 25°C, I _D = 1.0mA |
| R _{DS(on)} | Static Drain-to-Source On-State Resistance | — | — | 0.18 | Ω | V _{GS} = 10V, I _D = 10.2A ④ |
| | | — | — | 0.25 | | V _{GS} = 10V, I _D = 16A |
| V _{GS(th)} | Gate Threshold Voltage | 2.0 | — | 4.0 | V | V _{DS} = V _{GS} , I _D = 250μA |
| g _{fs} | Forward Transconductance | 6.1 | — | — | S (S) | V _{DS} ≥ 15V, I _{DS} = 10.2A ④ |
| I _{DSS} | Zero Gate Voltage Drain Current | — | — | 25 | μA | V _{DS} = 0.8 x max. rating, V _{GS} = 0V |
| | | — | — | 250 | | V _{DS} = 0.8 x max. rating V _{GS} = 0V, T _J = 25°C |
| I _{GSS} | Gate-to-Source Leakage Forward | — | — | 100 | nA | V _{GS} = 20V |
| I _{GSS} | Gate-to-Source Leakage Reverse | — | — | -100 | | V _{GS} = -20V |
| Q _g | Total Gate Charge | 32 | — | 60 | nC | V _{GS} = 10V, I _D = 16A |
| Q _{gs} | Gate-to-Source Charge | 2.2 | — | 10.6 | | V _{DS} = Max. Rating x 0.5 |
| Q _{gd} | Gate-to-Drain ('Miller') Charge | 14.2 | — | 37.6 | | see figures 6 and 13 |
| t _{d(on)} | Turn-On Delay Time | — | — | 20 | ns | V _{DD} = 100V, I _D = 16A, R _G = 9.1Ω V _{GS} = 10V see figure 10 |
| t _r | Rise Time | — | — | 152 | | |
| t _{d(off)} | Turn-Off Delay Time | — | — | 58 | | |
| t _f | Fall Time | — | — | 67 | | |
| LD | Internal Drain Inductance | — | 8.7 | — | | |
| LS | Internal Source Inductance | — | 8.7 | — | nH | Measured from the drain lead, 6mm (0.25 in.) from package to center of die. Measured from the source lead, 6mm (0.25 in.) from package to source bonding pad. |
| C _{iss} | Input Capacitance | — | 1300 | — | pF | V _{GS} = 0V, V _{DS} = 25V f = 1.0MHz. see figure 5 |
| C _{oss} | Output Capacitance | — | 400 | — | | |
| C _{rss} | Reverse Transfer Capacitance | — | 130 | — | | |

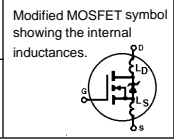

Source-Drain Diode Ratings and Characteristics

| | Parameter | Min. | Typ. | Max. | Units | Test Conditions |
|-----------------|--|--|------|------|-------|---|
| I _S | Continuous Source Current (Body Diode) | — | — | 16 | A | Modified MOSFET symbol showing the integral reverse p-n junction rectifier. |
| I _{SM} | Pulse Source Current (Body Diode) ① | — | — | 64 | | |
| V _{SD} | Diode Forward Voltage | — | — | 1.5 | V | T _J = 25°C, I _S = 16A, V _{GS} = 0V ④ |
| t _{rr} | Reverse Recovery Time | — | — | 500 | ns | T _J = 25°C, I _F = 16A, di/dt ≤ 100 A/μs |
| Q _{RR} | Reverse Recovery Charge | — | — | 5.3 | μC | V _{DD} ≤ 50 V ④ |
| t _{on} | Forward Turn-On Time | Intrinsic turn-on time is negligible. Turn-on speed is substantially controlled by L _S + L _D . | | | | |



Thermal Resistance

| | Parameter | Min. | Typ. | Max. | Units | Test Conditions |
|-------------------|---------------------|------|------|------|-------|---|
| R _{thJC} | Junction-to-Case | — | — | 1.25 | KW ⑤ | Typical socket mount Mounting surface flat, smooth |
| R _{thJA} | Junction-to-Ambient | — | — | 80 | | |
| R _{thCS} | Case-to-Sink | — | 0.21 | — | | |

IRFY240CM Device

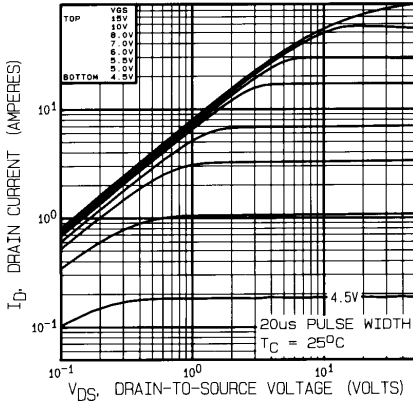

Fig. 1 — Typical Output Characteristics
 $T_C = 25^\circ\text{C}$

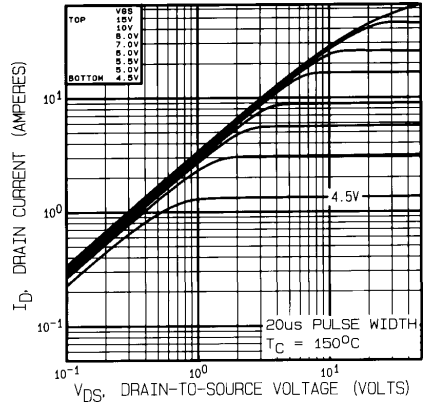

Fig. 2 — Typical Output Characteristics
 $T_C = 150^\circ\text{C}$

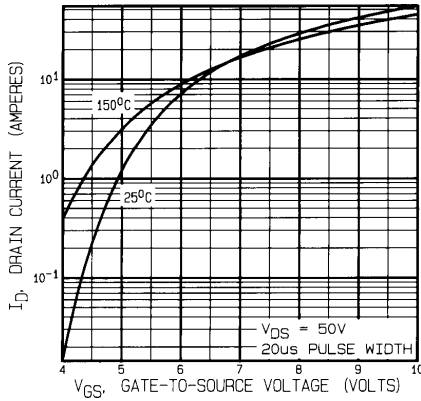

Fig. 3 — Typical Transfer Characteristics

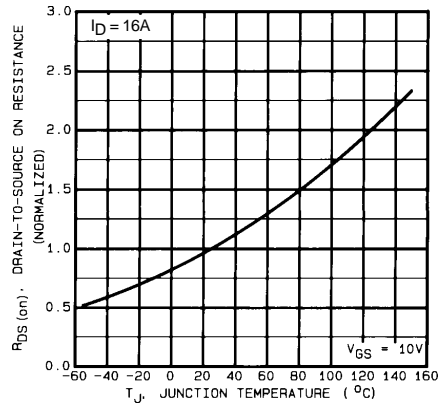

Fig. 4 — Normalized On-Resistance Vs. Temperature

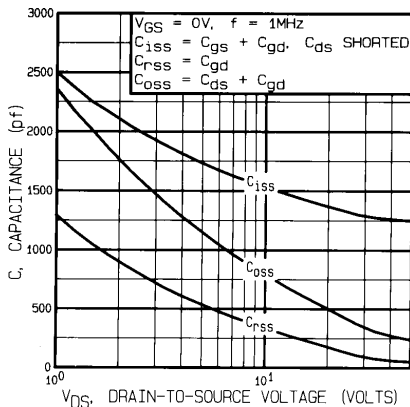

Fig. 5 — Typical Capacitance Vs. Drain-to-Source Voltage

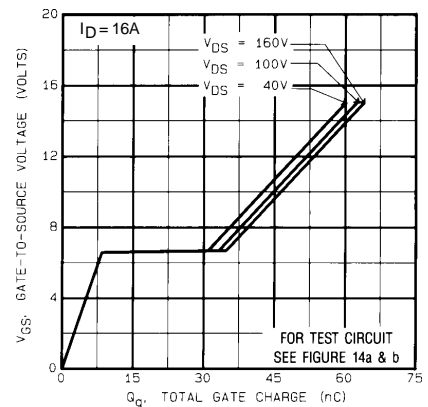

Fig. 6 — Typical Gate Charge Vs. Gate-to-Source Voltage

IRFY240CM Device

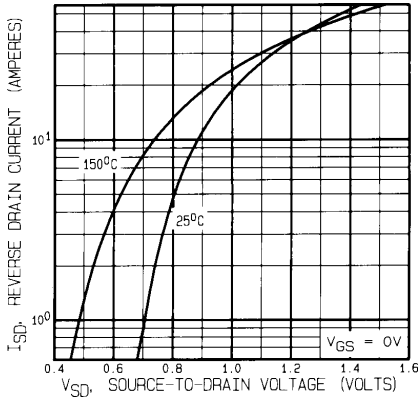

Fig. 7 — Typical Source-to-Drain Diode Forward Voltage

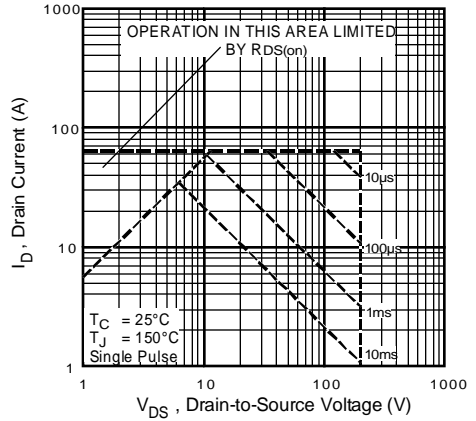

Fig. 8 — Maximum Safe Operating Area

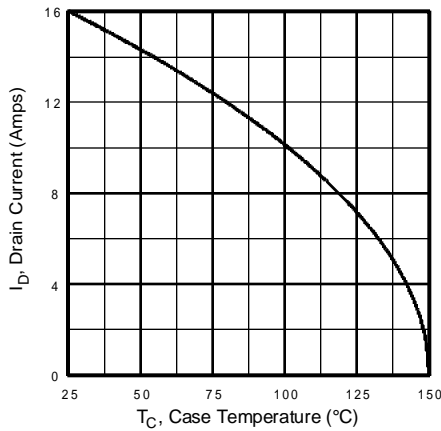

Fig. 9 — Maximum Drain Current Vs. Case Temperature

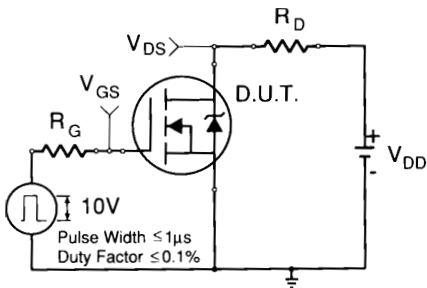

Fig. 10a — Switching Time Test Circuit

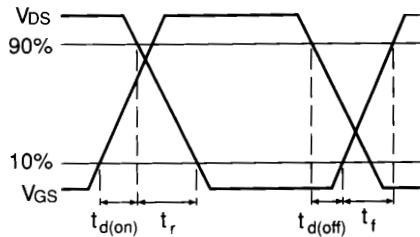

Fig. 10b — Switching Time Waveforms

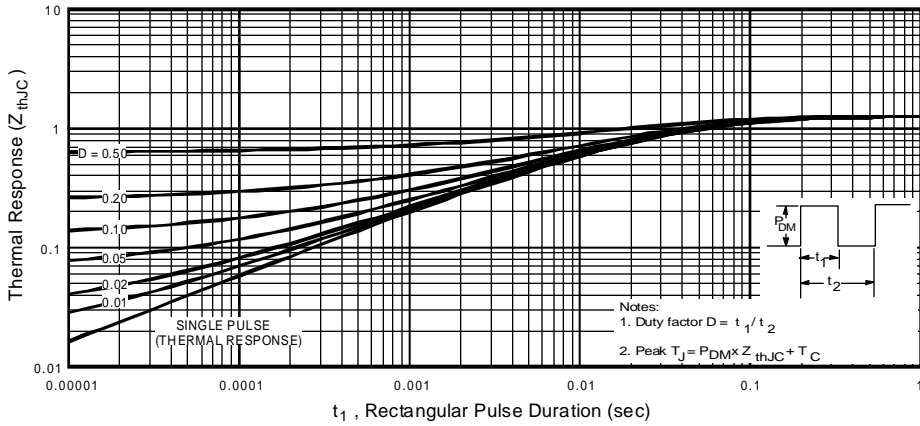

Fig. 11 — Maximum Effective Transient Thermal Impedance, Junction-to-Case Vs. Pulse Duration

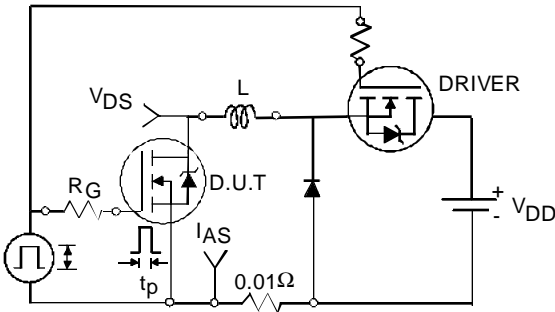

Fig. 12a — Unclamped Inductive Test Circuit

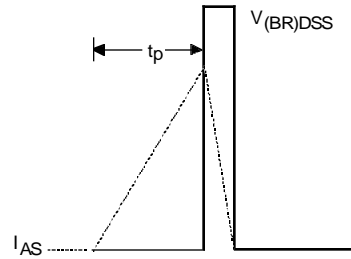

Fig. 12b — Unclamped Inductive Waveforms

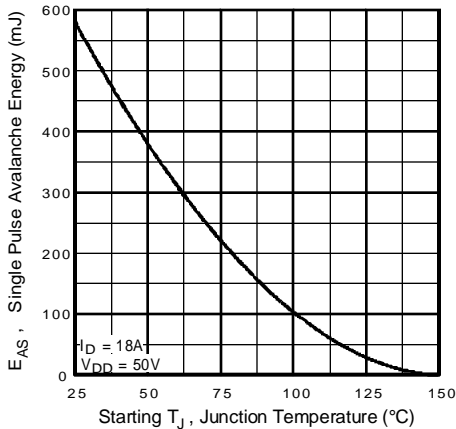

Fig. 12c — Max. Avalanche Energy vs. Current

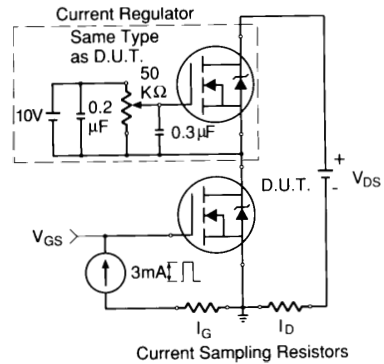

Fig. 13a — Gate Charge Test Circuit

IRFY240CM Device

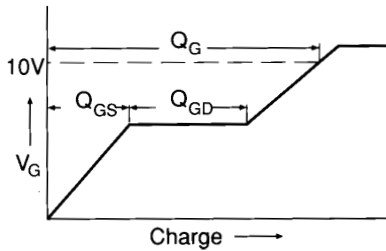
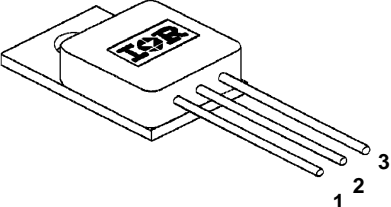
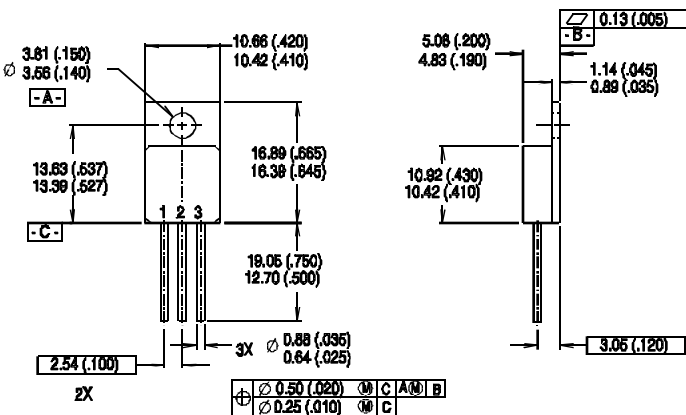

Fig. 13b — Basic Gate Charge Waveform

Notes:

- ① Repetitive Rating; Pulse width limited by maximum junction temperature (see figure 11).
- ② @ $V_{DD} = 50V$, Starting $T_J = 25^\circ C$,
 $E_{AS} = [0.5 * L * (I_G^2) * [BV_{DSS}/(BV_{DSS}-V_{DD})]]$
 Peak $I_L = 16A$, $V_{GS} = 10V$, $25 \leq R_G \leq 200\Omega$ (figure 12)
- ③ $I_{SD} \leq 16A$, $di/dt \leq 150A/\mu s$, $V_{DD} \leq BV_{DSS}$, $T_J \leq 150^\circ C$
- ④ Pulse width $\leq 300 \mu s$; Duty Cycle $\leq 2\%$
- ⑤ $K/W = ^\circ C/W$ $W/K = W/^\circ C$

Case Outline and Dimensions — TO-257AA

| | |
|---|--|
| <p>Pin 1 - Drain Pin 2 - Source Pin 3 - Gate</p>  <p style="text-align: center;">TO-257AA</p> |  <p style="text-align: center;">NON-STANDARD PIN CONFIGURATION</p> <p style="text-align: center;">Pin 1 - Gate Pin 2 - Drain Pin 3 - Source</p> <p style="text-align: center;">Order Part Type IRFY240C</p> <p>NOTES:</p> <ol style="list-style-type: none"> 1. Dimensioning and tolerancing per ANSI Y14.5M-1982 2. Controlling dimension: Inch 3. Dimensions are shown in millimeters (Inches) 4. Outline conforms to JEDEC outline TO-257AA |
|---|--|

CAUTION

BERYLLIA WARNING PER MIL-PRF-19500

Packages containing beryllia shall not be ground, sandblasted, machined or have other operations performed on them which will produce beryllia or beryllium dust. Furthermore, beryllium oxide packages shall not be placed in acids that will produce fumes containing beryllium.

International **IOR** Rectifier

WORLD HEADQUARTERS: 233 Kansas St., El Segundo, California 90245, Tel: (310) 322 3331
EUROPEAN HEADQUARTERS: Hurst Green, Oxted, Surrey RH8 9BB, UK Tel: ++ 44(0) 1883 732020
IR CANADA: 7321 Victoria Park Ave., Suite 201, Markham, Ontario L3R 2Z8, Tel: (905) 475 1897
IR GERMANY: Saalburgstrasse 157, 61350 Bad Homburg Tel: ++ 49 6172 96590
IR ITALY: Via Liguria 49, 10071 Borgaro, Torino Tel: ++ 39 11 451 0111
IR FAR EAST: K&H Bldg., 2F, 3-30-4 Nishi-Ikeburo 3-Chome, Toshima-Ki, Tokyo Japan 171 Tel: 81 3 3983 0086
IR SOUTHEAST ASIA: 315 Outram Road, #10-02 Tan Boon Liat Building, Singapore 0316 Tel: 65 221 8371
<http://www.irf.com/> Data and specifications subject to change without notice. 7/96