

Major Ratings and Characteristics

Characteristics	50SQ...	Units
$I_{F(AV)}$ Rectangular waveform	5	A
V_{RRM} range	60 / 100	V
I_{FSM} @ tp = 5 μ s sine	1900	A
V_F @ 5 Apk, $T_J = 125^\circ\text{C}$	0.52	V
T_J range	-55 to 175	$^\circ\text{C}$

Description/ Features

The 50SQ... axial leaded Schottky rectifier series has been optimized for low reverse leakage at high temperature. The proprietary barrier technology allows for reliable operation up to 175°C junction temperature. Typical applications are in switching power supplies, converters, free-wheeling diodes, and reverse battery protection.

- 175° C T_J operation
- High purity, high temperature epoxy encapsulation for enhanced mechanical strength and moisture resistance
- Low forward voltage drop
- High frequency operation
- Guard ring for enhanced ruggedness and long term reliability
- Lead-Free plating

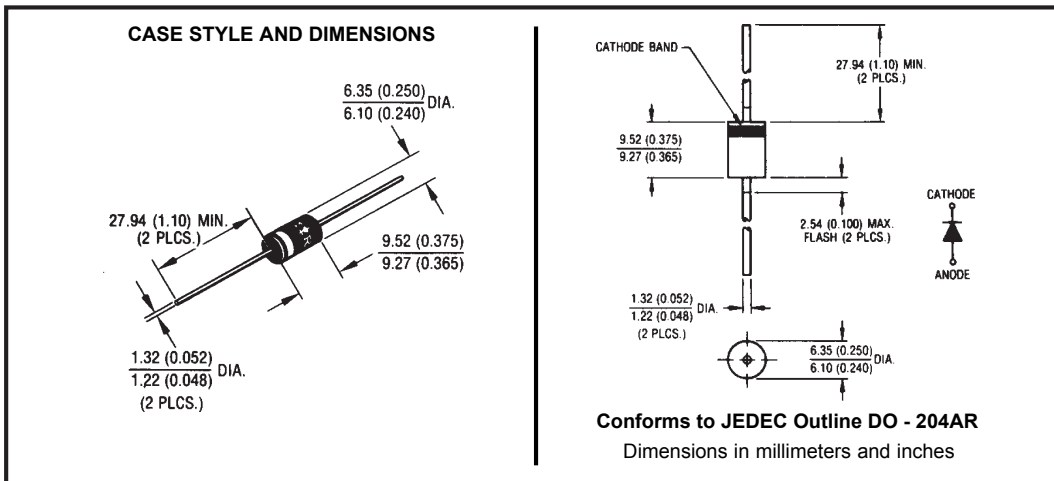

Voltage Ratings

Part number	50SQ060	50SQ080	50SQ100
V_R Max. DC Reverse Voltage (V)	60	80	100
V_{RWM} Max. Working Peak Reverse Voltage (V)			

Absolute Maximum Ratings

Parameters	50SQ	Units	Conditions
$I_{F(AV)}$ Max. Average Forward Current * See Fig. 5	5	A	50% duty cycle @ $T_C = 119^\circ\text{C}$, rectangular wave form
I_{FSM} Max. Peak One Cycle Non-Repetitive Surge Current * See Fig. 7	1900	A	5 μs Sine or 3 μs Rect. pulse
	290		10ms Sine or 6ms Rect. pulse
E_{AS} Non-Repetitive Avalanche Energy	7.5	mJ	$T_J = 25^\circ\text{C}$, $I_{AS} = 1.0\text{Amps}$, $L = 15\text{mH}$
I_{AR} Repetitive Avalanche Current	1.0	A	Current decaying linearly to zero in 1 μsec Frequency limited by T_J max. $V_A = 1.5 \times V_R$ typical

Electrical Specifications

Parameters	50SQ	Units	Conditions
V_{FM} Max. Forward Voltage Drop (1) * See Fig. 1	0.66	V	@ 5A
	0.77	V	@ 10A
	0.52	V	@ 5A
	0.62	V	@ 10A
I_{RM} Max. Reverse Leakage Current (1) * See Fig. 2	0.55	mA	$T_J = 25^\circ\text{C}$
	7	mA	$T_J = 125^\circ\text{C}$
C_T Max. Junction Capacitance	500	pF	$V_R = 5V_{DC}$, (test signal range 100Khz to 1Mhz) 25°C
L_S Typical Series Inductance	10	nH	Measured lead to lead 5mm from body
dv/dt Max. Voltage Rate of Change (Rated V_R)	10000	V/ μs	

(1) Pulse Width < 300 μs , Duty Cycle < 2%

Thermal-Mechanical Specifications

Parameters	50SQ	Units	Conditions
T_J Max. Junction Temperature Range	-55 to 175	$^\circ\text{C}$	
T_{stg} Max. Storage Temperature Range	-55 to 175	$^\circ\text{C}$	
R_{thJL} Max. Thermal Resistance Junction to Lead	8.0	$^\circ\text{C/W}$	DC operation * See Fig. 4 1/8 inch lead length
R_{thJA} Typical Thermal Resistance, Junction to Air	44	$^\circ\text{C/W}$	
wt Approximate Weight	1.4(0.049)	g (oz.)	
Case Style	DO-204AR		JEDEC

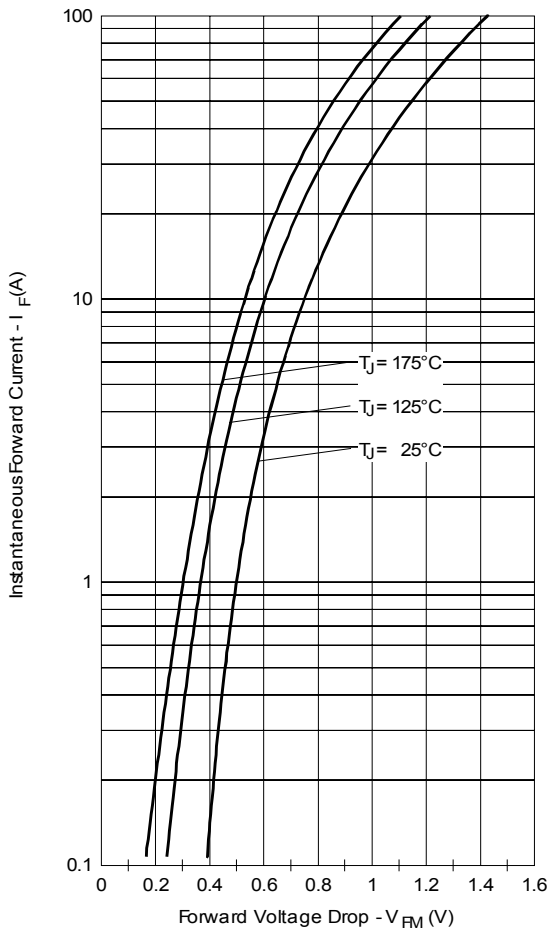

Fig. 1 - Maximum Forward Voltage Drop Characteristics

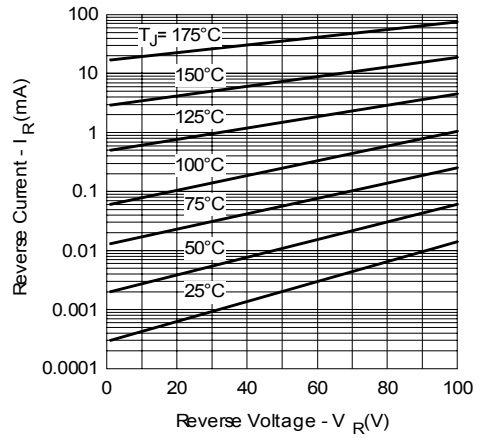

Fig. 2 - Typical Values of Reverse Current Vs. Reverse Voltage

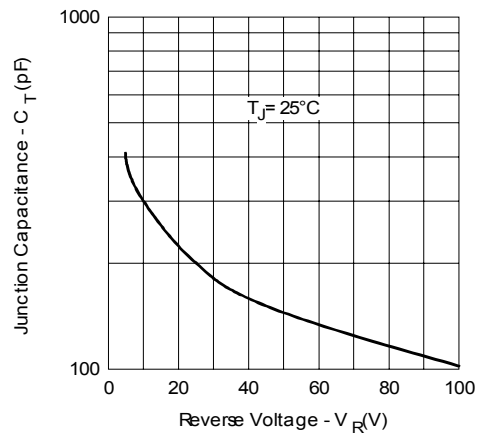

Fig. 3 - Typical Junction Capacitance Vs. Reverse Voltage

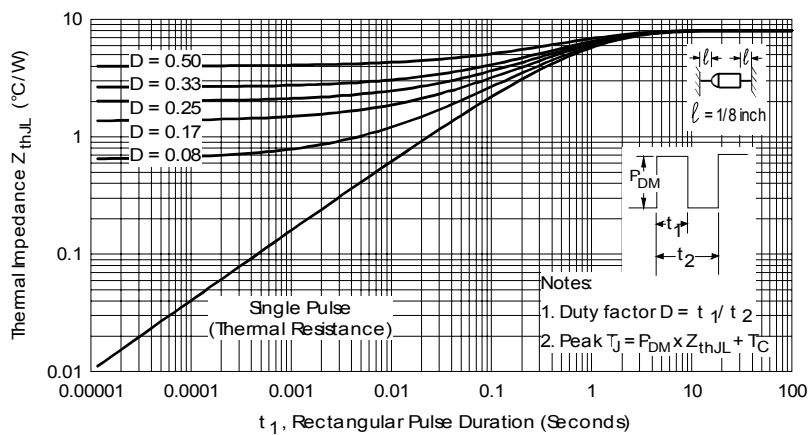

Fig. 4 - Maximum Thermal Impedance Z_{thJL} Characteristics

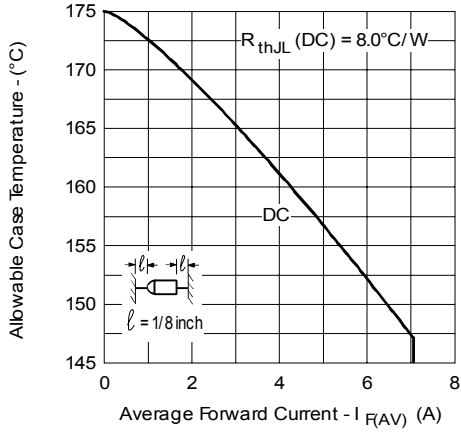

Fig. 5 - Maximum Allowable Case Temperature Vs. Average Forward Current

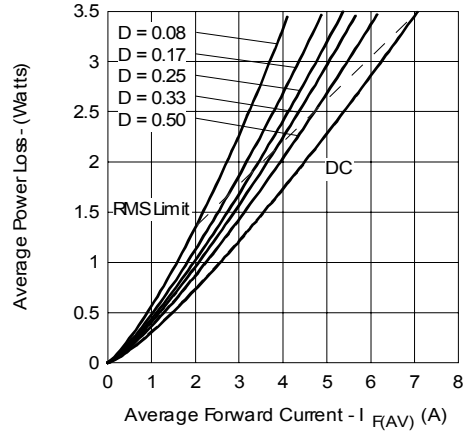

Fig. 6 - Forward Power Loss Characteristics

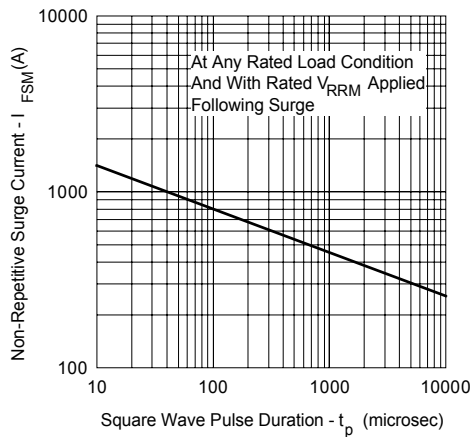

Fig. 7 - Maximum Non-Repetitive Surge Current

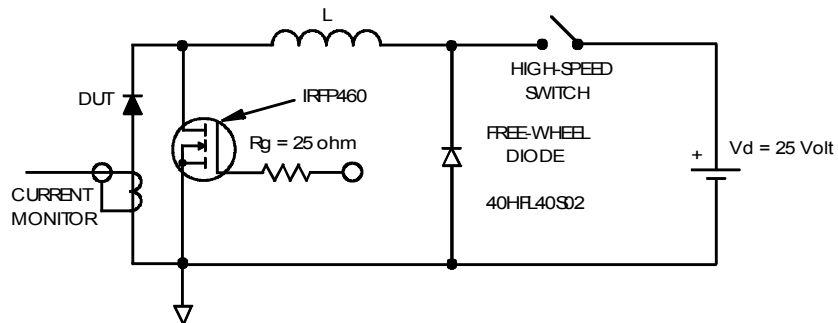

Fig. 8 - Unclamped Inductive Test Circuit

Ordering Information Table

Device Code											
	<table border="1" style="margin: auto;"> <tr> <td style="padding: 5px;">50</td> <td style="padding: 5px;">S</td> <td style="padding: 5px;">Q</td> <td style="padding: 5px;">100</td> <td style="padding: 5px;">TR</td> </tr> <tr> <td style="text-align: center;">①</td> <td style="text-align: center;">②</td> <td style="text-align: center;">③</td> <td style="text-align: center;">④</td> <td style="text-align: center;">⑤</td> </tr> </table>	50	S	Q	100	TR	①	②	③	④	⑤
50	S	Q	100	TR							
①	②	③	④	⑤							
1	- 50 = current x 10										
2	- S = DO-204AR										
3	- Q = Schottky Q Series										
4	- Voltage Rating										
5	- TR = Tape & Reel package (1500 pcs)										
	- = Box package (200 pcs)										

060 = 60V
080 = 80V
100 = 100V

Data and specifications subject to change without notice.
 This product has been designed and qualified for Industrial Level and Lead-Free.
 Qualification Standards can be found on IR's Web site.