



15CTQ...
15CTQ...S
15CTQ... -1

SCHOTTKY RECTIFIER

15 Amp

$$I_{F(AV)} = 15\text{Amp}$$

$$V_R = 35/ 45\text{V}$$

Major Ratings and Characteristics



Characteristics	Values	Units
$I_{F(AV)}$ Rectangular waveform	15	A
V_{RRM} range	35/ 45	V
I_{FSM} @ tp = 5 μ s sine	810	A
V_F @ 7.5 Apk, $T_J = 125^\circ\text{C}$ (per leg)	0.51	V
T_J range	-55 to 150	$^\circ\text{C}$

Description/Features

The 15CTQ center tap Schottky rectifier series has been optimized for very low forward voltage drop, with moderate leakage. The proprietary barrier technology allows for reliable operation up to 150 $^\circ\text{C}$ junction temperature. Typical applications are in switching power supplies, converters, free-wheeling diodes, and reverse battery protection.

- 150 $^\circ\text{C}$ T_J operation
- Center tap TO-220 package
- Low forward voltage drop
- High purity, high temperature epoxy encapsulation for enhanced mechanical strength and moisture resistance
- High frequency operation
- Guard ring for enhanced ruggedness and long term reliability

Case Styles

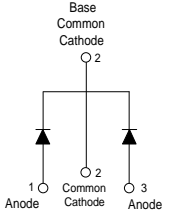
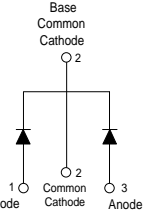
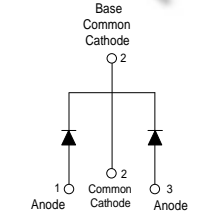
15CTQ...	15CTQ... S	15CTQ... -1
		
<p>Base Common Cathode</p> <p>2</p>  <p>1 Anode 2 Common Cathode 3 Anode</p> <p>TO-220</p>	<p>Base Common Cathode</p> <p>2</p>  <p>1 Anode 2 Common Cathode 3 Anode</p> <p>D²PAK</p>	<p>Base Common Cathode</p> <p>2</p>  <p>1 Anode 2 Common Cathode 3 Anode</p> <p>TO-262</p>

Voltage Ratings

Part number	15CTQ035	15CTQ040	15CTQ045
V_R Max. DC Reverse Voltage (V)	35	40	45
V_{RWM} Max. Working Peak Reverse Voltage (V)			

Absolute Maximum Ratings

Parameters	15CTQ	Units	Conditions
$I_{F(AV)}$ Max. Average Forward Current * See Fig. 5	15	A	50% duty cycle @ $T_C = 123^\circ\text{C}$, rectangular wave form
I_{FSM} Max. Peak One Cycle Non-Repetitive Surge Current (Per Leg) * See Fig. 7	810	A	5 μs Sine or 3 μs Rect. pulse Following any rated load condition and with rated V_{RWM} applied
	145		
E_{AS} Non-Repetitive Avalanche Energy (Per Leg)	10	mJ	$T_J = 25^\circ\text{C}$, $I_{AS} = 1.20$ Amps, $L = 11.10$ mH
I_{AR} Repetitive Avalanche Current (Per Leg)	1.5	A	Current decaying linearly to zero in 1 μsec Frequency limited by T_J max. $V_A = 1.5 \times V_R$ typical

Electrical Specifications

Parameters	15CTQ	Units	Conditions
V_{FM} Max. Forward Voltage Drop (Per Leg) * See Fig. 1 (1)	0.55	V	@ 7.5A $T_J = 25^\circ\text{C}$
	0.70	V	@ 15A
	0.51	V	@ 7.5A $T_J = 125^\circ\text{C}$
	0.65	V	@ 15A
I_{RM} Max. Reverse Leakage Current (Per Leg) * See Fig. 2 (1)	0.8	mA	$T_J = 25^\circ\text{C}$ $V_R = \text{rated } V_R$
	32	mA	$T_J = 125^\circ\text{C}$
C_T Max. Junction Capacitance(Per Leg)	400	pF	$V_R = 5V_{DC}$ (test signal range 100Khz to 1Mhz) 25°C
L_S Typical Series Inductance (Per Leg)	8.0	nH	Measured lead to lead 5mm from package body
dv/dt Max. Voltage Rate of Change (Rated V_R)	10,000	V/ μs	

(1) Pulse Width < 300 μs , Duty Cycle <2%

Thermal-Mechanical Specifications

Parameters	15CTQ	Units	Conditions
T_J Max. Junction Temperature Range	-55 to 150	$^\circ\text{C}$	
T_{stg} Max. Storage Temperature Range	-55 to 150	$^\circ\text{C}$	
R_{thJC} Max. Thermal Resistance Junction to Case (Per Leg)	3.50	$^\circ\text{C}/\text{W}$	DC operation * See Fig. 4
R_{thJC} Max. Thermal Resistance Junction to Case (Per Package)	1.75	$^\circ\text{C}/\text{W}$	DC operation
R_{thCS} Typical Thermal Resistance, Case to Heatsink	0.50	$^\circ\text{C}/\text{W}$	Mounting surface, smooth and greased
wt Approximate Weight	2 (0.07)	g (oz.)	
T Mounting Torque	Min.	6 (5)	Kg-cm (lbf-in)
	Max.	12 (10)	

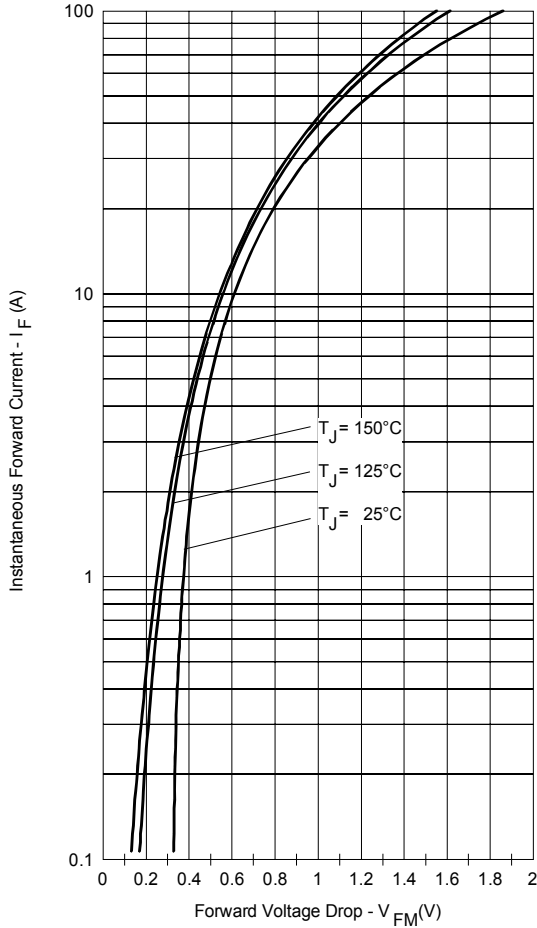

Fig. 1 - Max. Forward Voltage Drop Characteristics (Per Leg)

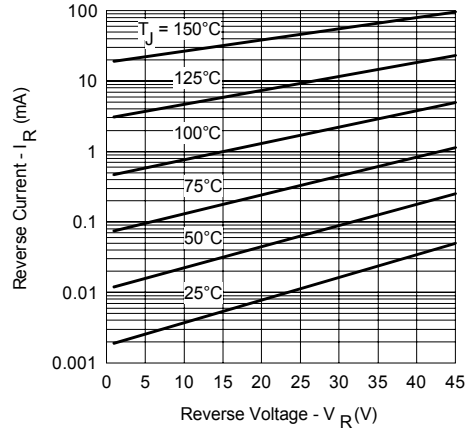

Fig. 2 - Typical Values Of Reverse Current Vs. Reverse Voltage (Per Leg)

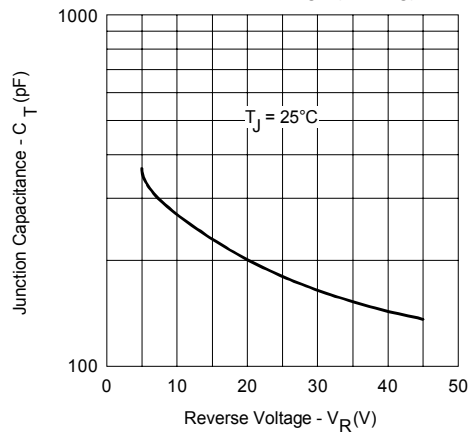

Fig. 3 - Typical Junction Capacitance Vs. Reverse Voltage (Per Leg)

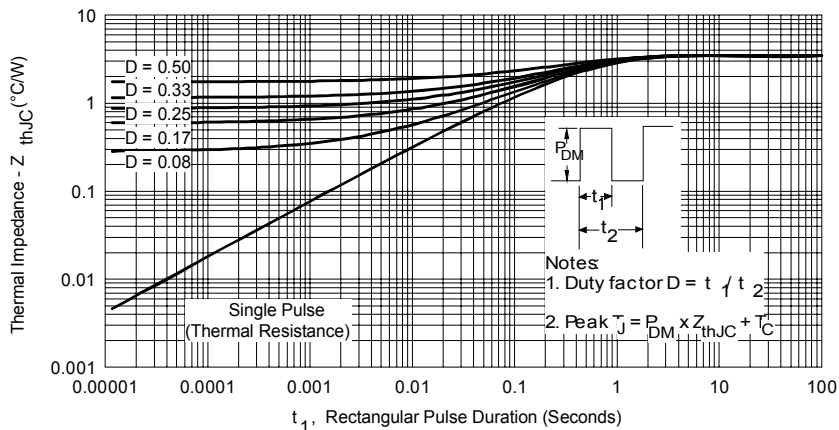

Fig. 4 - Max. Thermal Impedance Z_{thJC} Characteristics (Per Leg)

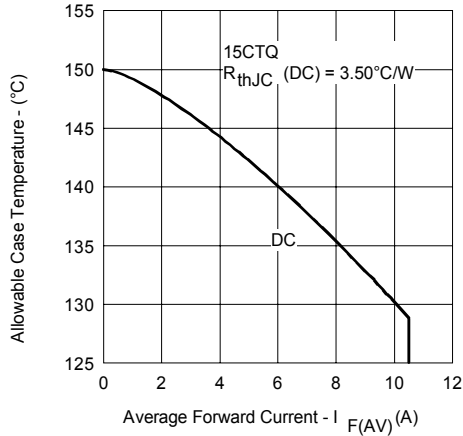

Fig. 5 - Max. Allowable Case Temperature Vs. Average Forward Current (Per Leg)

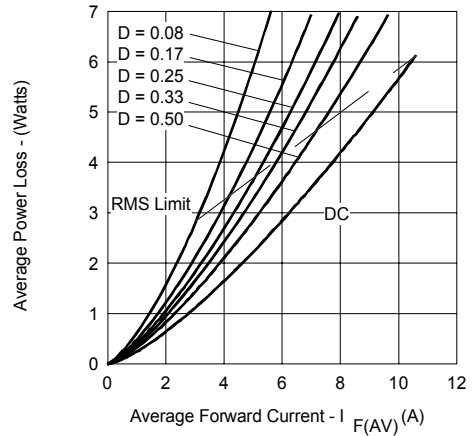

Fig. 6 - Forward Power Loss Characteristics (Per Leg)

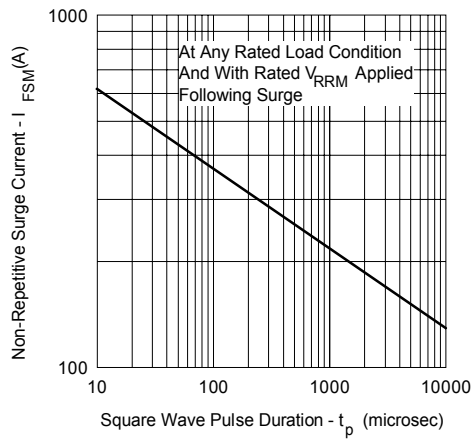

Fig. 7 - Max. Non-Repetitive Surge Current (Per Leg)

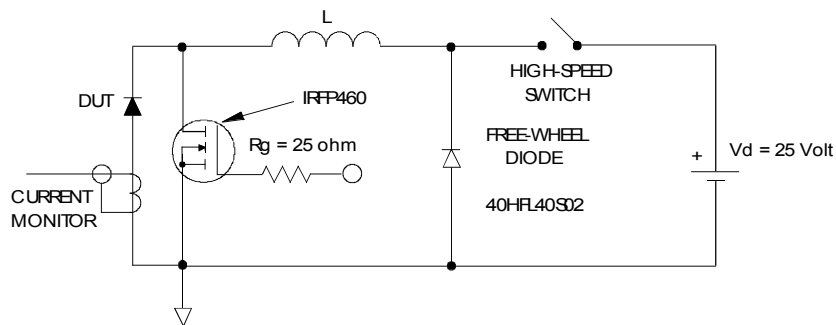
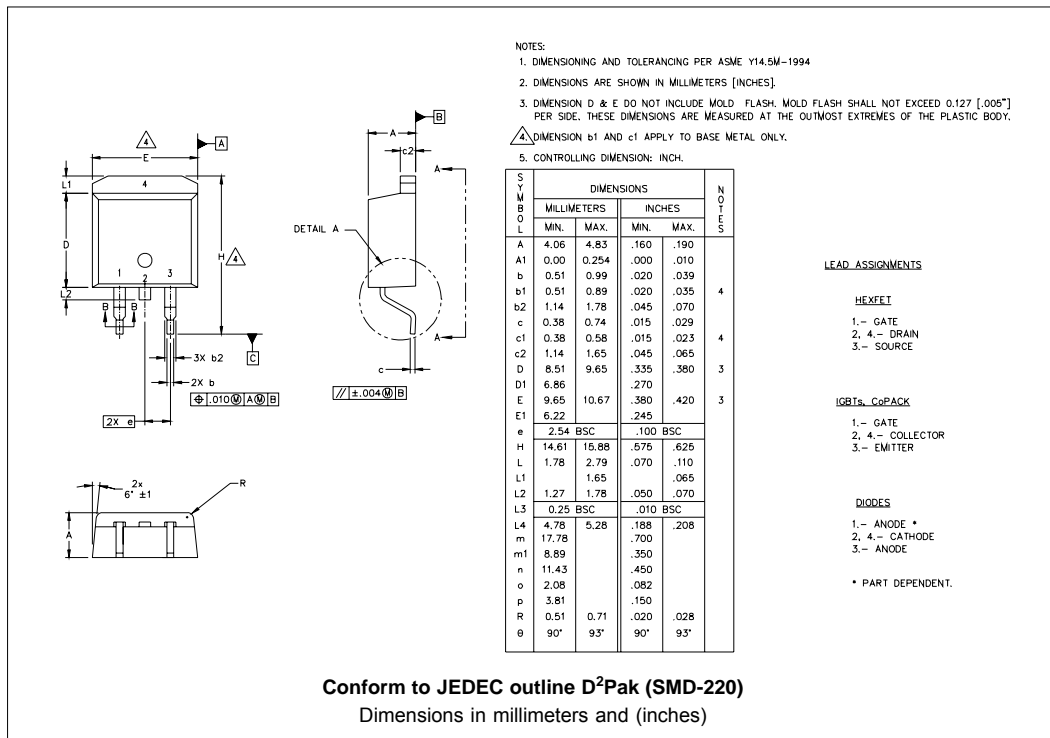
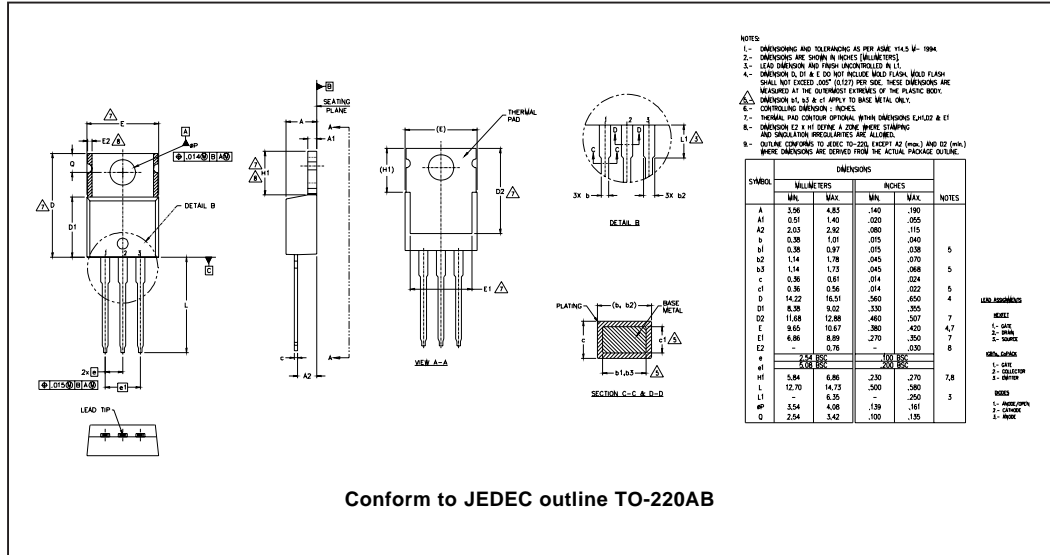
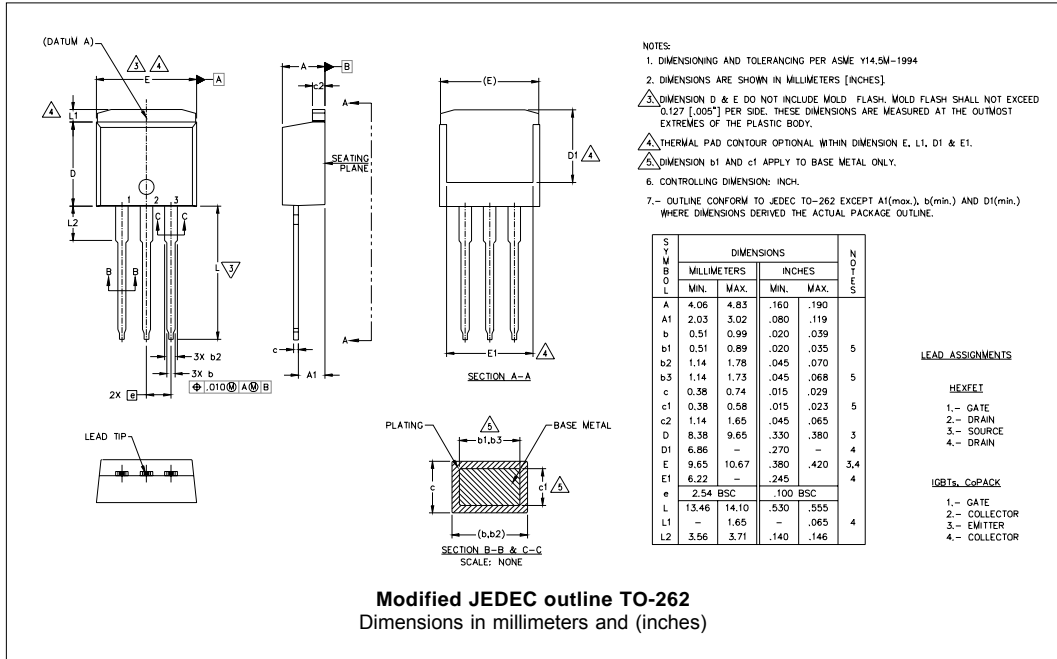

Fig. 8 - Unclamped Inductive Test Circuit

Outline Table



Outline Table



Tape & Reel Information

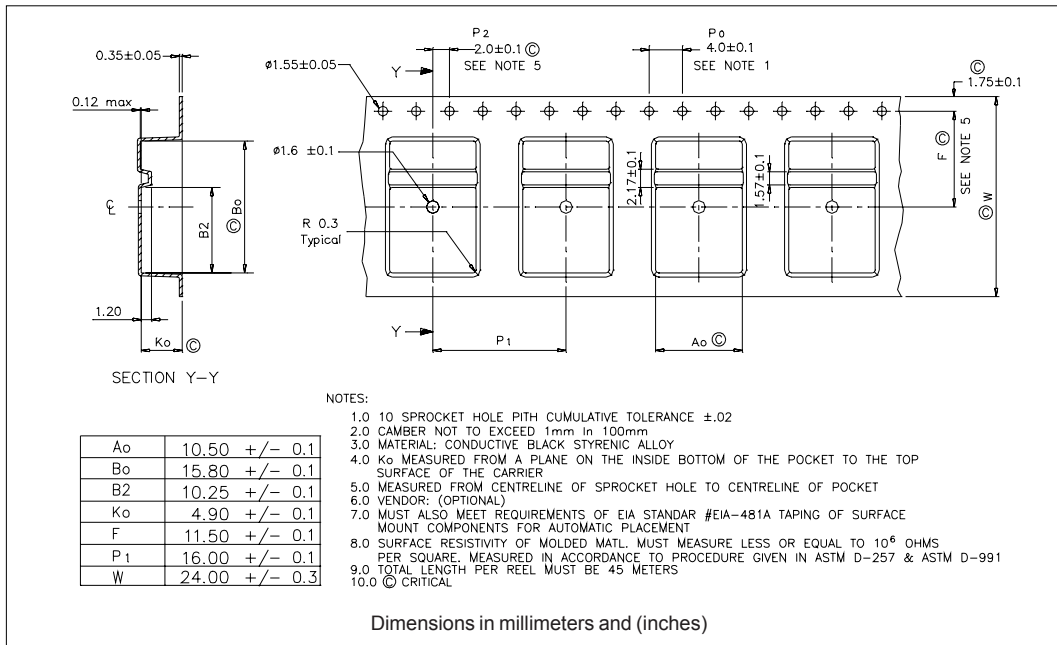

Part Marking Information

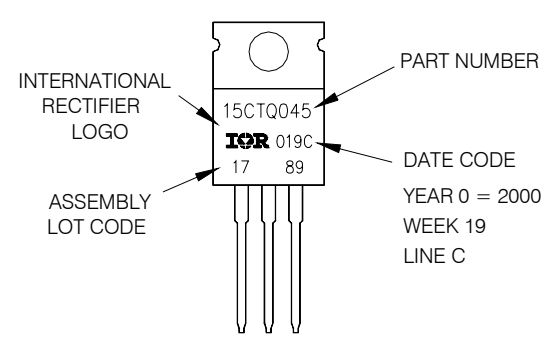
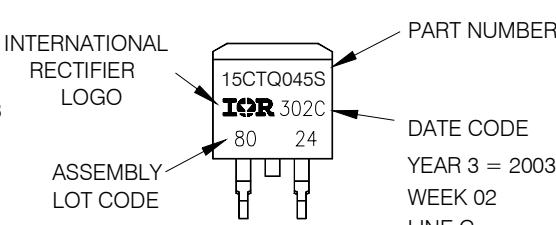
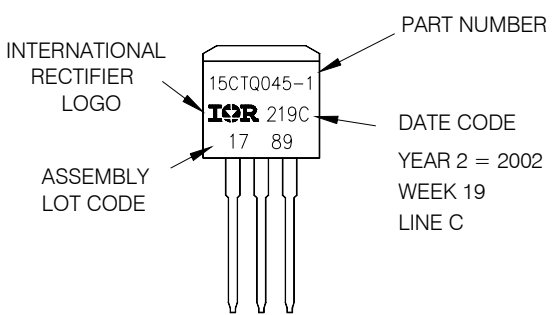
<p>TO-220</p> <p>EXAMPLE: THIS IS A 15CTQ045 LOT CODE 1789 ASSEMBLED ON WW 19, 2000 IN THE ASSEMBLY LINE "C"</p>	 <p>INTERNATIONAL RECTIFIER LOGO</p> <p>ASSEMBLY LOT CODE</p> <p>PART NUMBER</p> <p>DATE CODE YEAR 0 = 2000 WEEK 19 LINE C</p>
<p>D²PAK</p> <p>EXAMPLE: THIS IS A 15CTQ045S LOT CODE 8024 ASSEMBLED ON WW 02, 2003 IN ASSEMBLY LINE "C"</p>	 <p>INTERNATIONAL RECTIFIER LOGO</p> <p>ASSEMBLY LOT CODE</p> <p>PART NUMBER</p> <p>DATE CODE YEAR 3 = 2003 WEEK 02 LINE C</p>
<p>TO-262</p> <p>EXAMPLE: THIS IS A 15CTQ045-1 LOT CODE 1789 ASSEMBLED ON WW 19, 2002 IN ASSEMBLY LINE "C"</p>	 <p>INTERNATIONAL RECTIFIER LOGO</p> <p>ASSEMBLY LOT CODE</p> <p>PART NUMBER</p> <p>DATE CODE YEAR 2 = 2002 WEEK 19 LINE C</p>

Ordering Information Table

Device Code																	
	<table border="1" style="margin: auto;"> <tr> <td style="padding: 5px;">15</td> <td style="padding: 5px;">C</td> <td style="padding: 5px;">T</td> <td style="padding: 5px;">Q</td> <td style="padding: 5px;">045</td> <td style="padding: 5px;">S</td> <td style="padding: 5px;">TRL</td> <td style="padding: 5px;">-</td> </tr> <tr> <td style="text-align: center;">(1)</td> <td style="text-align: center;">(2)</td> <td style="text-align: center;">(3)</td> <td style="text-align: center;">(4)</td> <td style="text-align: center;">(5)</td> <td style="text-align: center;">(6)</td> <td style="text-align: center;">(7)</td> <td style="text-align: center;">(8)</td> </tr> </table>	15	C	T	Q	045	S	TRL	-	(1)	(2)	(3)	(4)	(5)	(6)	(7)	(8)
15	C	T	Q	045	S	TRL	-										
(1)	(2)	(3)	(4)	(5)	(6)	(7)	(8)										
1	- Current Rating (15A)																
2	- Circuit Configuration C = Common Cathode																
3	- T = TO-220																
4	- Schottky "Q" Series																
5	- Voltage Ratings																
6	- <ul style="list-style-type: none"> • S = D²Pak • -1= TO-262 																
7	- <ul style="list-style-type: none"> • none = Tube (50 pieces) • TRL = Tape & Reel (Left Oriented - for D²Pak only) • TRR = Tape & Reel (Right Oriented - for D²Pak only) 																
8	- <ul style="list-style-type: none"> • none = Standard Production • PbF = Lead-Free 																

035 = 35V
 040 = 40V
 045 = 45V

Data and specifications subject to change without notice.
 This product has been designed and qualified for Industrial Level.
 Qualification Standards can be found on IR's Web site.