

$$I_{F(AV)} = 12\text{Amp}$$

$$V_R = 35/ 45\text{V}$$

Major Ratings and Characteristics

Characteristics	Values	Units
$I_{F(AV)}$ Rectangular waveform	12	A
V_{RRM} range	35/ 45	V
I_{FSM} @ tp = 5 μ s sine	690	A
V_F @6 Apk, $T_J = 125^\circ\text{C}$ (per leg)	0.53	V
T_J range	-55 to 175	$^\circ\text{C}$

Description/ Features

The 12CTQ...PbF center tap Schottky rectifier series has been optimized for low reverse leakage at high temperature. The proprietary barrier technology allows for reliable operation up to 175° C junction temperature. Typical applications are in switching power supplies, converters, free-wheeling diodes, and reverse battery protection.

- 175° C T_J operation
- Center tap TO-220 package
- Low forward voltage drop
- High purity, high temperature epoxy encapsulation for enhanced mechanical strength and moisture resistance
- High frequency operation
- Guard ring for enhanced ruggedness and long term reliability
- Lead-Free ("PbF" suffix)

Case Styles

12CTQ...PbF



TO-220

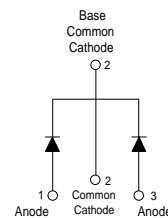

12CTQ...PbF Series

Bulletin PD-20828 rev. B 05/06

International
IRF Rectifier

Voltage Ratings

Part number	12CTQ035PbF	12CTQ040PbF	12CTQ045PbF
V_R Max. DC Reverse Voltage (V)	35	40	45
V_{RWM} Max. Working Peak Reverse Voltage (V)			

Absolute Maximum Ratings

Parameters	12CTQ	Units	Conditions
$I_{F(AV)}$ Max. Average Forward (Per Leg) Current * See Fig. 5 (Per Device)	6	A	50% duty cycle @ $T_C = 160^\circ\text{C}$, rectangular wave form
	12		
I_{FSM} Max. Peak One Cycle Non-Repetitive Surge Current (Per Leg) * See Fig. 7	690	A	5 μs Sine or 3 μs Rect. pulse 10ms Sine or 6ms Rect. pulse Following any rated load condition and with rated V_{RRM} applied
	140		
E_{AS} Non-Repetitive Avalanche Energy (Per Leg)	8	mJ	$T_J = 25^\circ\text{C}$, $I_{AS} = 1.20$ Amps, $L = 11.10$ mH
I_{AR} Repetitive Avalanche Current (Per Leg)	1.20	A	Current decaying linearly to zero in 1 μsec Frequency limited by T_J max. $V_A = 1.5 \times V_R$ typical

Electrical Specifications

Parameters	12CTQ	Units	Conditions
V_{FM} Max. Forward Voltage Drop (Per Leg) * See Fig. 1 (1)	0.60	V	@ 6A $T_J = 25^\circ\text{C}$
	0.73	V	@ 12A
	0.53	V	@ 6A $T_J = 125^\circ\text{C}$
	0.64	V	@ 12A
I_{RM} Max. Reverse Leakage Current (Per Leg) * See Fig. 2 (1)	0.8	mA	$T_J = 25^\circ\text{C}$
	7.0	mA	$T_J = 125^\circ\text{C}$ $V_R = \text{rated } V_R$
$V_{F(TO)}$ Threshold Voltage	0.35	V	$T_J = T_J \text{ max.}$
r_t Forward Slope Resistance	18.23	m Ω	
C_T Max. Junction Capacitance (Per Leg)	400	pF	$V_R = 5V_{DC}$ (test signal range 100Khz to 1Mhz) 25°C
L_S Typical Series Inductance (Per Leg)	8.0	nH	Measured lead to lead 5mm from package body
dv/dt Max. Voltage Rate of Change	10000	V/ μs	(Rated V_R)

(1) Pulse Width < 300 μs , Duty Cycle <2%

Thermal-Mechanical Specifications

Parameters	12CTQ	Units	Conditions
T_J Max. Junction Temperature Range	-55 to 175	$^\circ\text{C}$	
T_{stg} Max. Storage Temperature Range	-55 to 175	$^\circ\text{C}$	
R_{thJC} Max. Thermal Resistance Junction to Case (Per Leg)	3.50	$^\circ\text{C/W}$	DC operation * See Fig. 4
R_{thJC} Max. Thermal Resistance Junction to Case (Per Package)	1.75	$^\circ\text{C/W}$	DC operation
R_{thCS} Typical Thermal Resistance, Case to Heatsink	0.50	$^\circ\text{C/W}$	Mounting surface, smooth and greased
wt Approximate Weight	2(0.07)	g(oz.)	
T Mounting Torque	Min.	6(5)	Kg-cm (lbf-in)
	Max.	12(10)	
Marking Device	12CTQ045		

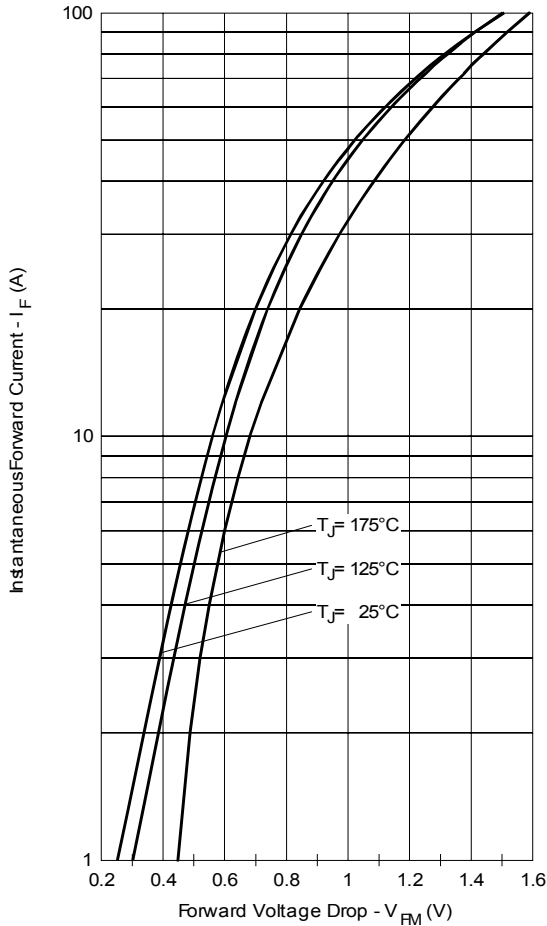

Fig. 1 - Max. Forward Voltage Drop Characteristics (Per Leg)

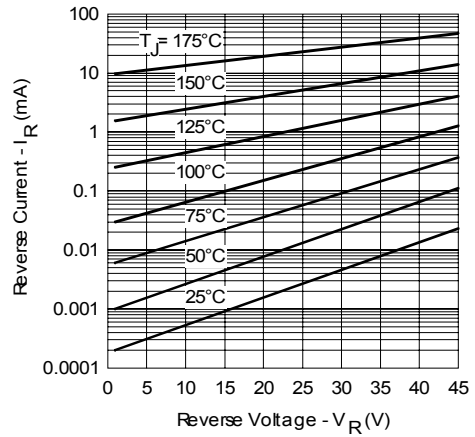

Fig. 2 - Typical Values Of Reverse Current Vs. Reverse Voltage (Per Leg)

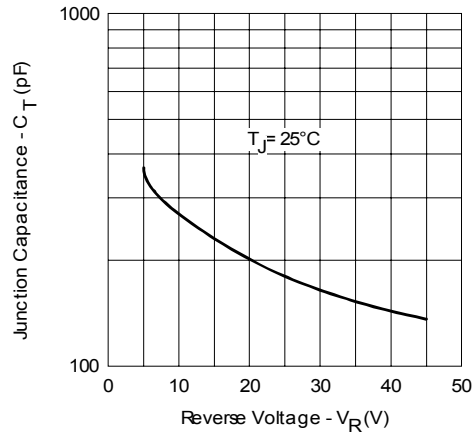

Fig. 3 - Typical Junction Capacitance Vs. Reverse Voltage (Per Leg)

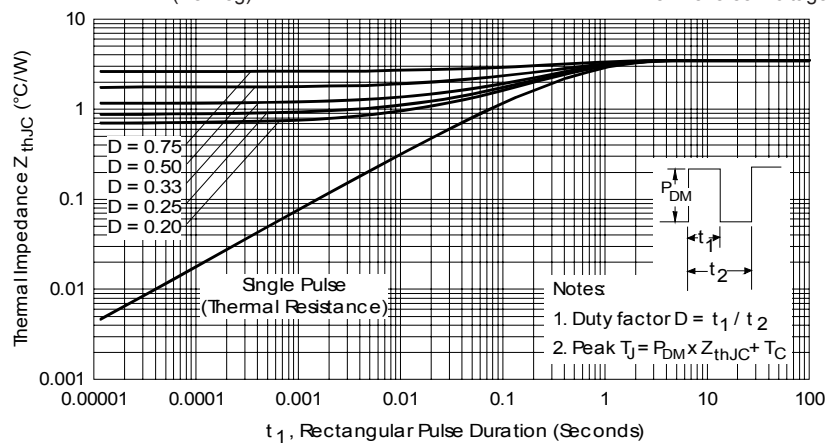

Fig. 4 - Max. Thermal Impedance Z_{thJC} Characteristics (Per Leg)

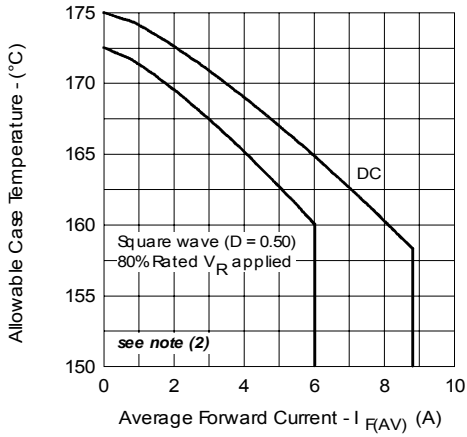

Fig. 5 - Max. Allowable Case Temperature Vs. Average Forward Current (Per Leg)

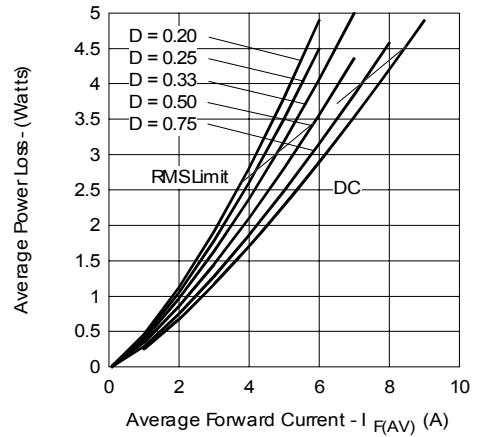

Fig. 6 - Forward Power Loss Characteristics (Per Leg)

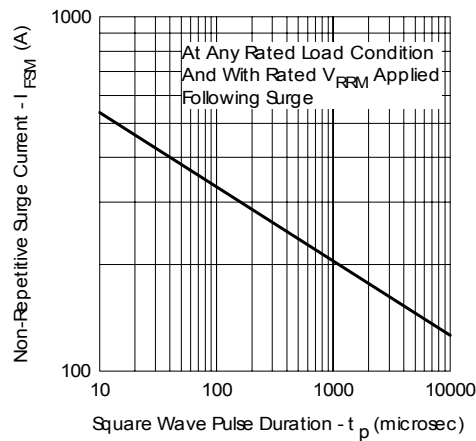

Fig. 7 - Max. Non-Repetitive Surge Current (Per Leg)

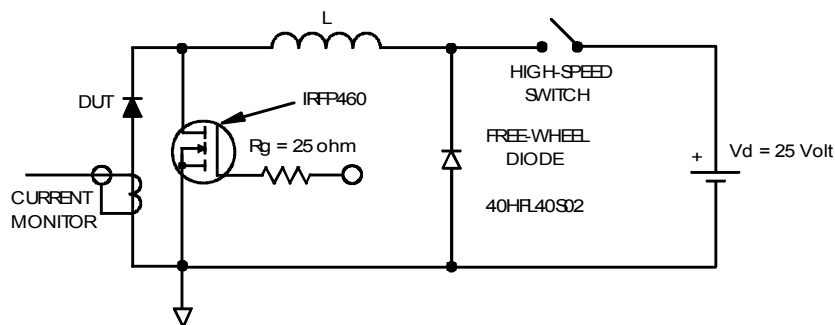

Fig. 8 - Unclamped Inductive Test Circuit

(2) Formula used: $T_C = T_J - (Pd + Pd_{REV}) \times R_{thJC}$;

Pd = Forward Power Loss = $I_{F(AV)} \times V_{FM} @ (I_{F(AV)} / D)$ (see Fig. 6);

Pd_{REV} = Inverse Power Loss = $V_{R1} \times I_R (1 - D)$; $I_R @ V_{R1} = 80\%$ rated V_R

Outline Table

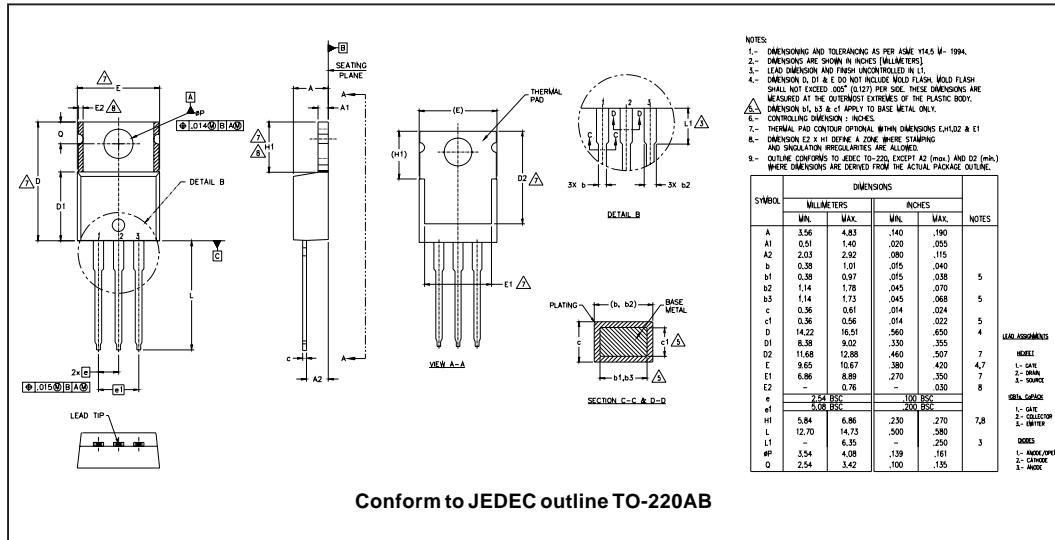

Part Marking Information

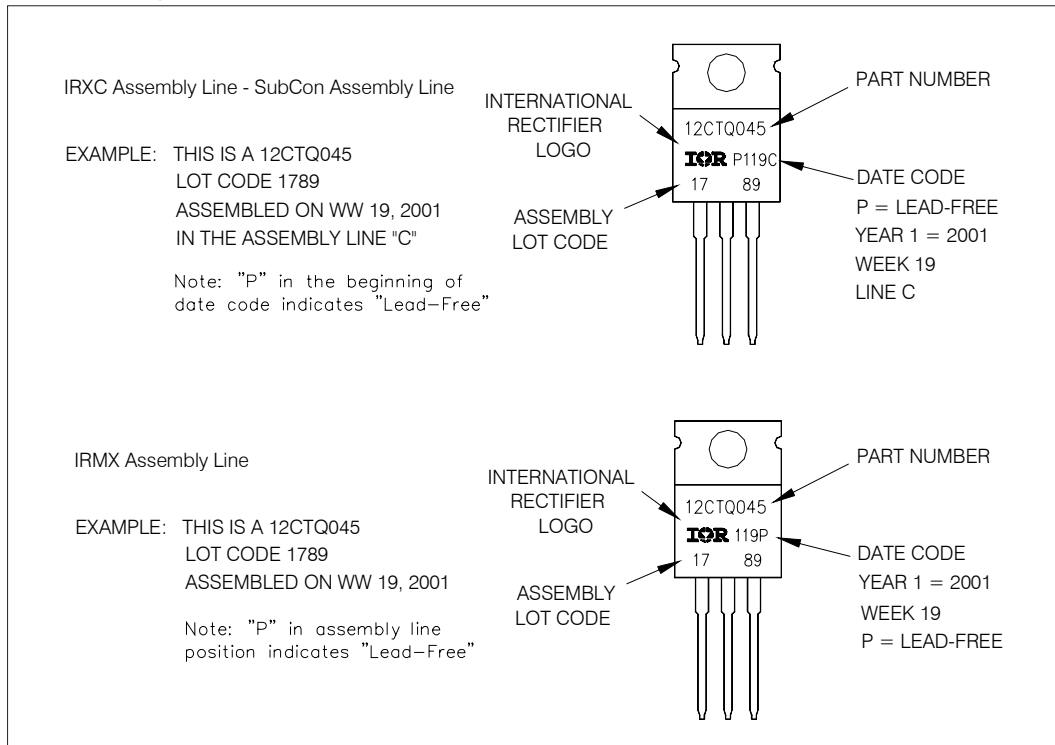

Ordering Information Table

Device Code	
12	C
①	②
T	Q
③	④
045	PbF
⑤	⑥

<p>1 - Current Rating (12 = 12A)</p> <p>2 - Circuit Configuration C = Common Cathode</p> <p>3 - Package T = TO-220</p> <p>4 - Schottky "Q" Series</p> <p>5 - Voltage Ratings</p> <p>6 - • none = Standard Production • PbF = Lead-Free</p>	<table border="1"> <tr> <td>035 = 35V</td> </tr> <tr> <td>040 = 40V</td> </tr> <tr> <td>045 = 45V</td> </tr> </table>	035 = 35V	040 = 40V	045 = 45V
035 = 35V				
040 = 40V				
045 = 45V				

Tube Standard Pack Quantity : 50 pieces

Data and specifications subject to change without notice.
This product has been designed and qualified for Industrial Level and Lead-Free.
Qualification Standards can be found on IR's Web site.