

60 W 12 V 5 V SMPS demo board with ICE5ASAG and IPA80R600P7

About this document



Scope and purpose

This document is an engineering report that describes a universal-input 60 W 12 V 5 V off-line isolated Flyback converter using the latest fifth-generation Infineon fixed-frequency controller (FFC) ICE5ASAG and CoolMOS™ IPA80R600P7, which offers high-efficiency, low standby power with selectable entry and exit standby power options, wide V_{CC} operating range with fast start-up, robust line protection with input overvoltage protection (OVP) and various protection modes for a highly reliable system. This demo board is designed for users who wish to evaluate the performance of ICE5ASAG and IPA80R600P7 in terms of optimized efficiency, thermal performance and EMI.

Intended audience

This document is intended for power supply design/application engineers, students, etc. who wish to design low-cost and highly reliable systems for off-line SMPS; either auxiliary power supplies for white goods, PCs, servers and TVs, or enclosed adapters for Blu-ray players, set-top boxes, games consoles, etc.

Table of contents

About this document	1
Table of contents	1
1 Abstract	3
2 Demo board	4
3 Specifications of the demo board	5
4 Circuit description	6
4.1 Line input.....	6
4.2 Start-up.....	6
4.3 PWM control with frequency reduction and switching MOSFET	6
4.4 Frequency jittering	7
4.5 RCD clamper circuit.....	7
4.6 Output stage	7
4.7 FB loop.....	7
4.8 ABM	7
5 Protection features	9
6 Circuit diagram	10
7 PCB layout	11
7.1 Top side	11
7.2 Bottom side	11
8 Bill of materials	12
9 Transformer construction	14



Table of contents

10 Test results15

10.1 Efficiency, regulation and output ripple..... 15

10.2 Standby power 16

10.3 Line regulation 17

10.4 Load regulation 17

10.5 Maximum input power 18

10.6 ESD immunity (EN 61000-4-2) 18

10.7 Surge immunity (EN 61000-4-5) 18

10.8 Conducted emissions (EN 55022 class B) 18

10.9 Thermal measurements 21

11 Waveforms and scope plots22

11.1 Start-up at low/high AC-line input voltage with maximum load..... 22

11.2 Soft-start..... 22

11.3 Drain and CS voltage at maximum load 23

11.4 Frequency jittering 23

11.5 Load transient response (dynamic load from 10% to 100%) 24

11.6 Output ripple voltage at maximum load 24

11.7 Output ripple voltage at ABM 1 W load..... 25

11.8 Entering ABM 25

11.9 During ABM 26

11.10 Leaving ABM 26

11.11 Line OVP (non-switch auto restart)..... 27

11.12 V_{CC} OVP (odd-skip auto restart) 27

11.13 V_{CC} UV protection (auto restart) 28

11.14 Over-load protection (odd-skip auto restart) 28

11.15 V_{CC} short-to-GND protection 29

12 References30

Revision history31

Abstract

1 Abstract

This document is an engineering report for a 60 W 12 V 5 V demo board designed in an FF isolated Flyback converter topology using the fifth-generation FFC ICE5ASAG and a P7 series of HV CoolMOS™ IPA80R600P7. The demo board is operated in Discontinuous Conduction Mode (DCM) and is running at 100 kHz fixed switching frequency. The frequency reduction with soft gate driving and frequency jittering offers lower EMI and better efficiency between light load and 50% load. The selectable Active Burst Mode (ABM) power enables ultra-low power consumption. In addition, numerous adjustable protection functions have been implemented in ICE5ASAG to protect the system and customize the IC for the chosen application. In case of failures like line overvoltage (OV), V_{CC} OV/undervoltage (UV), open control-loop or over-load, overtemperature, V_{CC} short-to-GND and CS short-to-GND, the device enters protection mode. By means of the cycle-by-cycle Peak Current Limitation (PCL), the dimensions of the transformer and current rating of the secondary diode can both be optimized. In this way, a cost-effective solution can easily be achieved. The target applications of ICE5ASAG are either auxiliary power supplies for white goods, PCs, servers and TVs, or enclosed adapters for Blu-ray players, set-top boxes, games consoles, etc.

Demo board

2 Demo board

This document contains the list of features, power supply specifications, schematics, bill of materials (BOM) and transformer construction documentation. Typical operating characteristics such as performance curve and scope waveforms are shown at the end of the report.

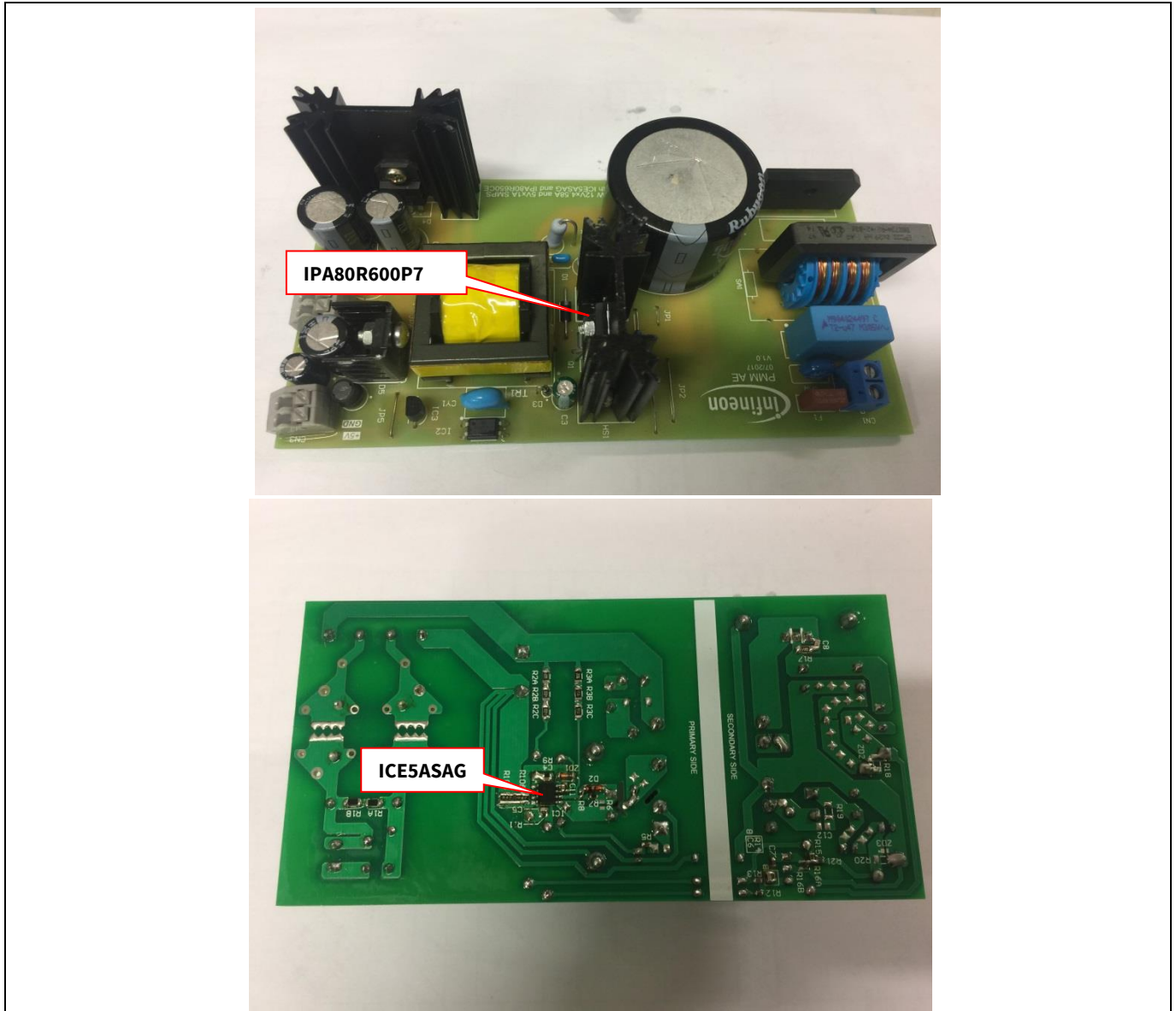

Figure 1 DEMO_5ASAG_60W1

Specifications of the demo board

3 Specifications of the demo board

Table 1 Specifications of DEMO_5ASAG_60W1

Input voltage and frequency	85 V AC (60 Hz) ~ 300 V AC (50 Hz)
Output voltage, current and power	(12 V × 4.58 A) + (5 V × 1 A) = 60 W
Regulation	+5 V: less than ±5% +12 V: less than ±5%
Output ripple voltage (full load, 85 V AC ~ 300 V AC)	5 V _{ripple_p-p} < 100 mV 12 V _{ripple_p-p} < 200 mV
Active mode four-point average efficiency (25%, 50%, 75%, 100% load)	> 83% at 115 V AC and 230 V AC
Standby power consumption	No load: P _{in} < 100 mW at 230 V AC 60 mW load: P _{in} < 170 mW at 230 V AC
Conducted emissions (EN 55022 class B)	Pass with 6 dB margin for 115 V AC and 6 dB margin for 230 V AC
ESD immunity (EN 61000-4-2)	Level 4 for contact discharge and level 3 for air discharge (±8 kV for both contact and air discharge)
Surge immunity (EN 61000-4-5)	Installation class 4 (±2 kV for line-to-line and ±4 kV for line-to-earth)
Form factor case size (L × W × H)	(144 × 73 × 43) mm

Note: “The demo board is designed for dual-output with cross-regulated loop feedback (FB). It may not regulate properly if loading is applied only to single-output. If the user wants to evaluate for single-output (12 V only) conditions, the following changes are necessary on the board.

1. Remove D5, L3, C13A, C13B, R21 (to disable 5 V output).
2. Change R16A to 10 kΩ and R15 to 38 kΩ (to disable 5 V FB and enable 100% weighted factor on 12 V output).

Since the board (especially the transformer) is designed for dual-output with optimized cross-regulation, single-output efficiency might not be optimized. It is only for IC functional evaluation under single-output conditions.”

Circuit description

4 Circuit description

4.1 Line input

The AC-line input side comprises the input fuse F1 as overcurrent (OC) protection. The choke L1, X-capacitor CX1 and Y-capacitor CY1 act as EMI suppressors. Optional spark-gap devices SA1, SA2 and varistor VAR can absorb HV stress during a lightning surge test. A rectified DC voltage (120 ~ 424 V DC) is obtained through the bridge rectifier BR1 together with bulk capacitor C1.

4.2 Start-up

To achieve fast and safe start-up, ICE5ASAG is implemented with start-up resistor and V_{CC} short-to-GND protection. When V_{VCC} reaches the turn-on voltage threshold 16 V, the IC begins with a soft-start. The soft-start implemented in ICE5ASAG is a digital time-based function. The preset soft-start time is 12 ms with four steps. If not limited by other functions, the peak voltage on the CS pin will increase incrementally from 0.3 V to 0.8 V. After IC turn-on, the V_{CC} voltage is supplied by auxiliary windings of the transformer. V_{CC} short-to-GND protection is implemented during the start-up time.

4.3 PWM control with frequency reduction and switching MOSFET

The PWM pulse is generated by the fifth-generation FF current-mode controller ICE5ASAG. The new controller can be operated in either DCM or Continuous Conduction Mode (CCM) with frequency-reduction mode to achieve the overall average efficiency. This demo board is designed to operate in DCM. When the system is operating at the maximum power, the controller will switch at the FF of 100 kHz. In order to achieve a better efficiency between light-load and medium-load conditions, frequency reduction is implemented, and this reduction curve is shown in Figure 2. The V_{CS} is clamped by the current limitation threshold or by the PWM op-amp while the switching frequency is reduced. After the maximum frequency reduction, the minimum switching frequency is f_{OSC4_MIN} (43 kHz).

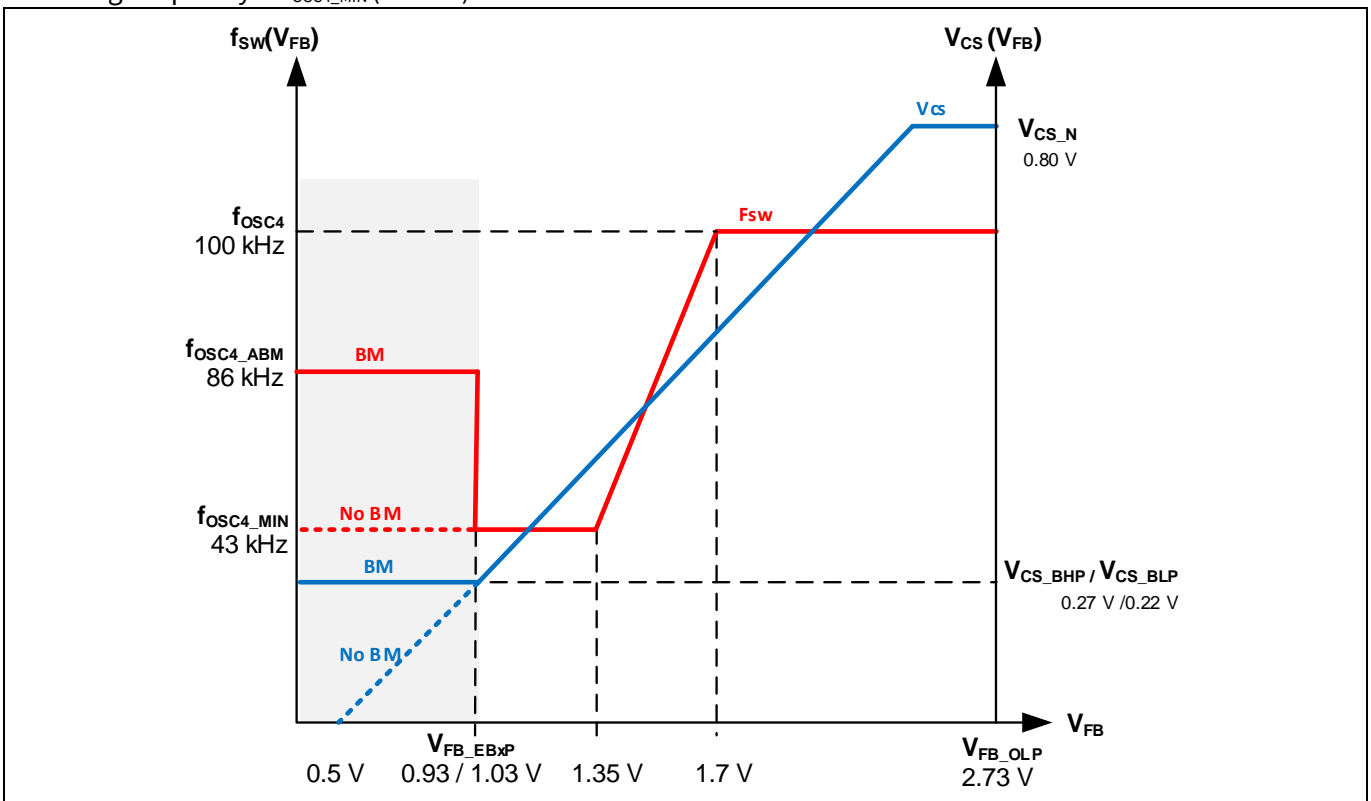

Figure 2 Frequency reduction curve

Circuit description

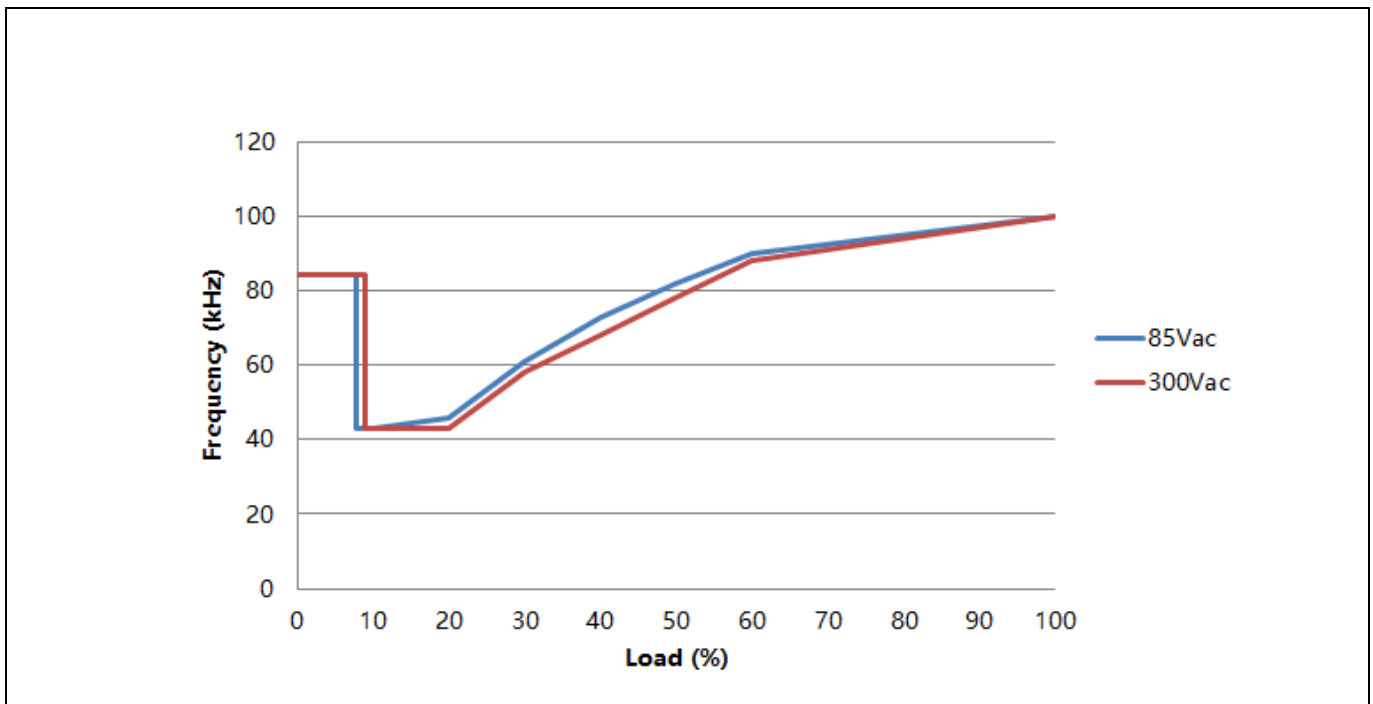

Figure 3 Frequency reduction curve of DEMO_5ASAG_60W1

The measured frequency reduction curve of DEMO_5ASAG_60W1 is shown in Figure 3.

4.4 Frequency jittering

The ICE5ASAG has a frequency jittering feature to reduce the EMI noise. The jitter frequency is internally set at 100 kHz (± 4 kHz) and the jitter period is 4 ms.

4.5 RCD clamper circuit

A clamper network (R4A, R4B, C2 and D1) dissipates the energy of the leakage inductance and suppresses ringing on the SMPS transformer.

4.6 Output stage

There are two outputs on the secondary side, 12 V and 5 V. The power is coupled out via Schottky diodes D4 and D5. The capacitors C9A, C9B and C13A provide energy buffering followed by the L-C filters L2-C10 and L3-C13B to reduce the output ripple and reduce interference between SMPS switching frequency and line frequency. Storage capacitors C9A, C9B and C13A are selected to have a very small ESR to minimize the output voltage ripple.

4.7 FB loop

For FB, the output is sensed by the voltage divider of R15, R21, R16A and compared to IC3 (TL431) internal reference voltage. C6, C7 and R14 comprise the compensation network. The output voltage of IC3 (TL431) is converted to the current signal via optocoupler IC2 and two resistors R12 and R13 for regulation control.

4.8 ABM

ABM entry and exit power (three levels) can be selected in ICE5ASAG. Details are illustrated in the product datasheet. Under light-load conditions, the SMPS enters ABM. At this stage, the controller is always active but

Circuit description

the V_{VCC} must be kept above the switch-off threshold. During ABM, the efficiency increases significantly and at the same time it supports low ripple on V_{out} and fast response on load-jump.

In order to enter ABM operation, two conditions must apply:

1. The FB voltage must be lower than the threshold of V_{FB_EBXP} .
2. There must be a certain blanking time ($t_{FB_BEB} = 36$ ms).

Once both of these conditions are fulfilled, the ABM flip-flop is set and the controller enters ABM operation. This dual-condition determination for entering ABM operation prevents mis-triggering of ABM, so that the controller enters ABM operation only when the output power is really low during the preset blanking time.

During ABM, the maximum Current Sense (CS) voltage is reduced from V_{CS_N} to V_{CS_BXP} to reduce the conduction loss and the audible noise. In ABM, the FB voltage is changing like a sawtooth between $V_{FB_Bon_ISO}$ and $V_{FB_Boff_ISO}$.

The FB voltage immediately increases if there is a high load-jump. This is observed by one comparator. As the current limit is 27/33% during ABM a certain load is needed so that FB voltage can exceed V_{FB_LB} (2.73 V). After leaving ABM, maximum current can then be provided to stabilize V_{out} .

Protection features

5 Protection features

Protection is one of the major factors in determining whether the system is safe and robust. Therefore, sufficient protection is necessary. ICE5ASAG provides comprehensive protections to ensure the system is operating safely. These include line OV, V_{CC} OV and UV, over-load, overtemperature (controller junction), CS short-to-GND and V_{CC} short-to-GND. When those faults are found, the system will enter protection mode until the fault is removed, when the system will resume normal operation. A list of protection functions and failure conditions are shown in the table below.

Table 2 Protection functions of ICE5ASAG

Protection function	Failure condition	Protection mode
Line OV	$V_{VIN} > 2.85 \text{ V}$	Non-switch auto restart
V_{CC} OV	$V_{VCC} > 25.5 \text{ V}$	Odd-skip auto restart
V_{CC} UV	$V_{VCC} < 10 \text{ V}$	Auto restart
Over-load	$V_{FB} > 2.73 \text{ V}$ and lasts for 54 ms	Odd-skip auto restart
Overtemperature (junction temperature of controller chip only)	$T_J > 140^\circ\text{C}$	Non-switch auto restart
CS short-to-GND	$V_{CS} < 0.1 \text{ V}$, lasts for 0.4 μs and three consecutive pulses	Odd-skip auto restart
V_{CC} short-to-GND ($V_{VCC} = 0 \text{ V}$, $R_{\text{Start-up}} = 50 \text{ M}\Omega$ and $V_{\text{DRAIN}} = 90 \text{ V}$)	$V_{VCC} < 1.2 \text{ V}$, $I_{VCC_Charge1} \approx -0.27 \text{ mA}$	Cannot start up

Circuit diagram

6 Circuit diagram

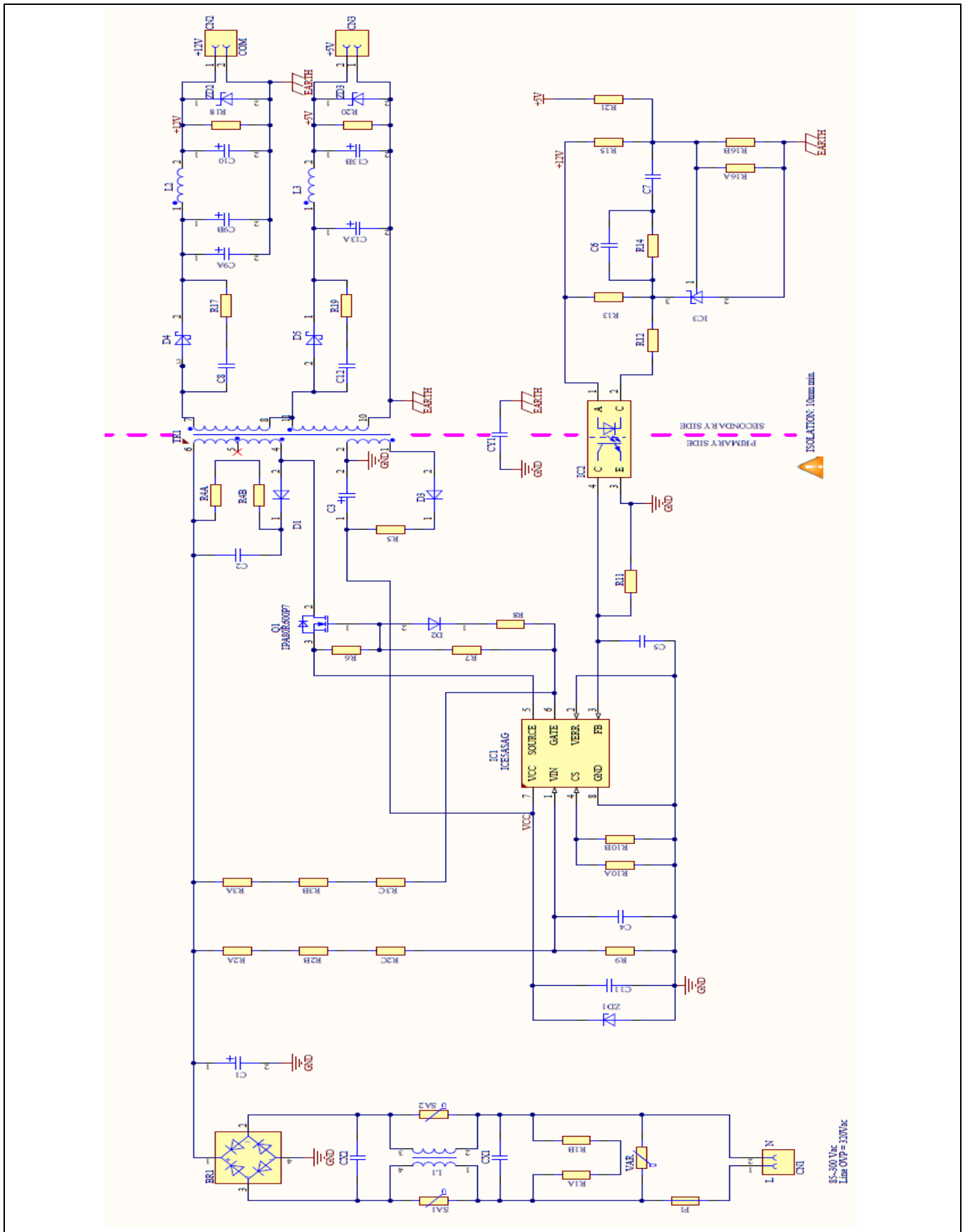

Figure 4 Schematic of DEMO_5ASAG_60W1

PCB layout

7 PCB layout

7.1 Top side

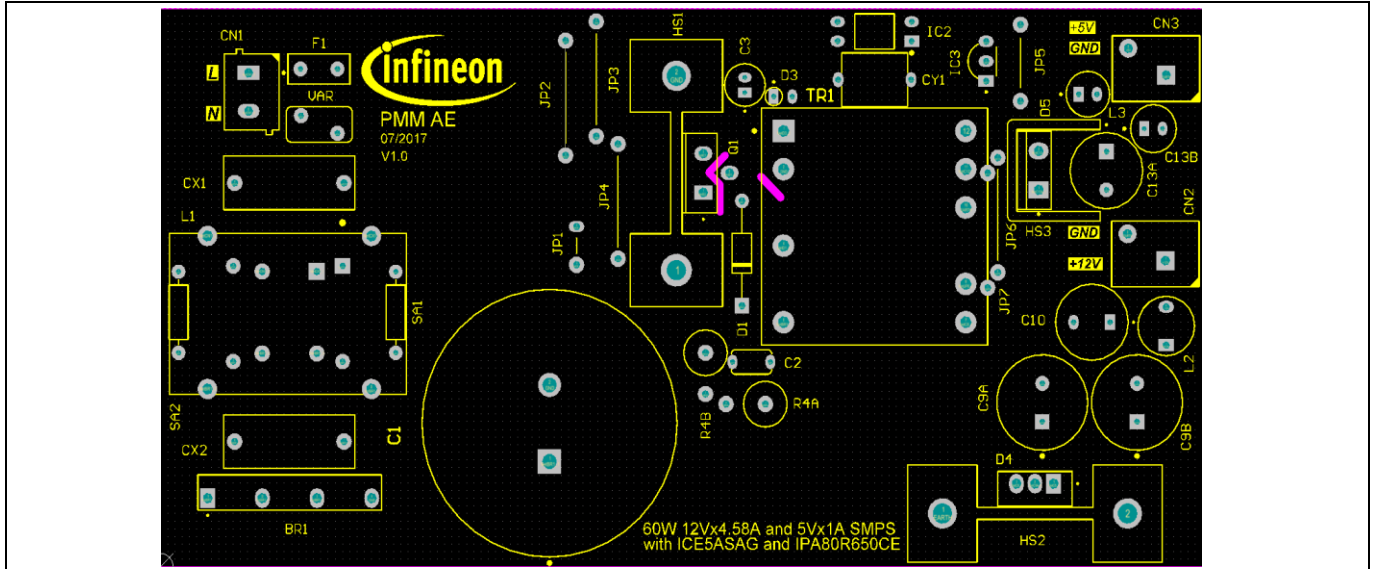

Figure 5 Top side component legend

7.2 Bottom side

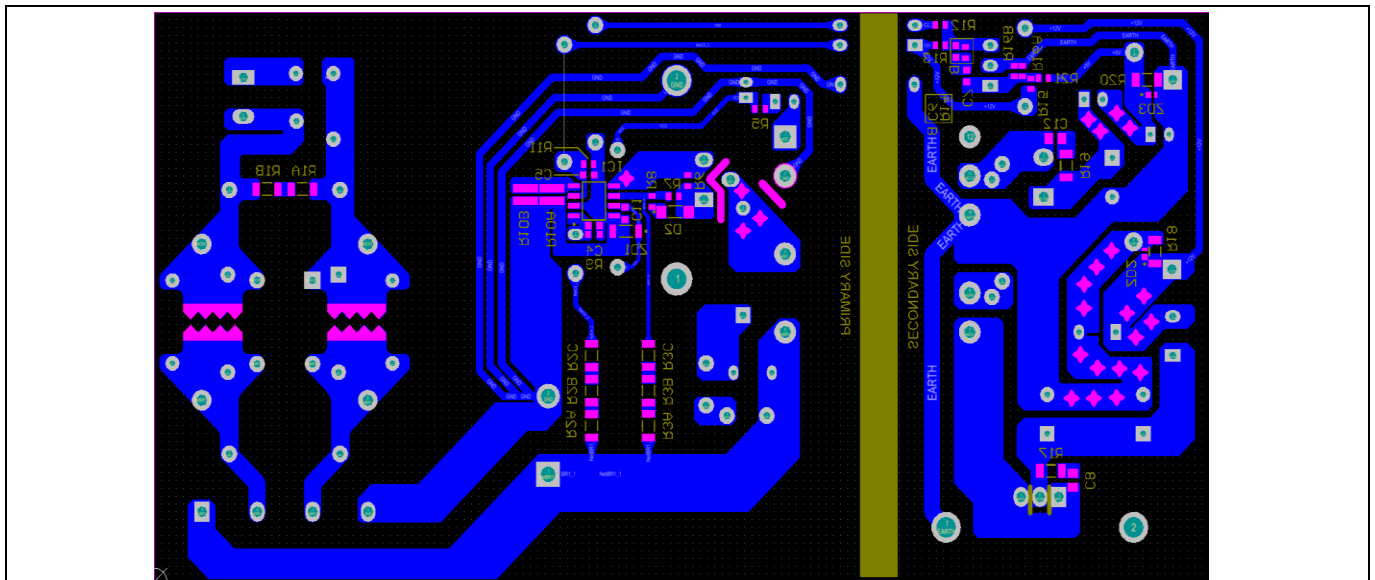

Figure 6 Bottom side copper and component legend

Bill of materials

8 Bill of materials

Table 3 BOM

No.	Designator	Description	Part number	Manufacturer	Quantity
1	BR1	600 V/4 A	D4SB60L	Shindengen	1
2	CX1	0.47 μ F, X-cap	B32922C3474	EPCOS/TDK	1
3	CY1	2.2 nF/500 V	DE1E3RA222MA4BQ	Murata	1
4	C1	180 μ F/500 V	500VXG180MEFCSN35X30	Rubycon	1
5	C2	1 nF/1000 V	RDE7U3A102J2M1H03A	Murata	1
6	C3	22 μ F/50 V	50PX22MEFC5X11	Rubycon	1
7	C11	100 nF/50 V	GRM188R71H104KA93D	Murata	1
8	C8	1 nF/100 V (0805)	GRM2162C2A102JA01#	Murata	1
9	C9A, C9B	1500 μ F/16 V	16ZLH1500MEFC10X20	Rubycon	2
10	C10	100 μ F/16 V	16ZLH100MEFC5X11	Rubycon	1
11	C7	220 nF/50 V (0603)	GRM188R71H224KAC4D	Murata	1
12	C4, C5, C6	1 nF/50 V (0603)	GRM1885C1H102GA01D	Murata	3
13	C13A	1500 μ F/10 V	10ZLH1500MEFC10X16	Rubycon	1
14	C13B	330 μ F/10 V	10ZLH330MEFC6.3X11	Rubycon	1
15	D1	800 V/1A	UF4006-E3/54	VISHAY	1
16	D2	0.2 A/100 V (SOD-80)	FDLL4148	Fairchild	1
17	D3	0.2 A/200 V (DO-35)	1N485B	Fairchild	1
18	D4	30 A/200 V	VF30200C		1
19	D5	10 A/45 V	VFT1045BP-M2/4W		1
20	F1	3.15 A/300 V	36913150000	Littlefuse	1
21	IC1	ICE5ASAG (DSO-8)	ICE5ASAG	Infineon	1
22	Q1	800 V, 0.6 Ω , TO-220	IPA80R600P7	Infineon	1
23	IC2	Optocoupler	SFH617A-3		1
24	IC3	Shunt regulator	TL431BVLPG		1
25	JP1-JP3, JP5-JP7	Jumper			6
26	JP4	Resistor, 27 Ω			1
27	L1	39 mH/1.4 A	B82734R2142B030	Epcos	1
28	L2	2.2 μ H, 6 A	744772022	Würth Electronics	1
29	L3	4.7 μ H, 4.2 A	7447462047	Würth Electronics	1
30	R4A, R4B	15 k Ω /2 W/350 V	ERG-2SJ153		2
31	R5, R7	15 Ω (0603)			2
32	R8	0 Ω (0603)			1
33	R10A, R10B	0.47 Ω /0.33 W	ERJB2BFR47V		2
34	R3A, R3B, R3C	15 M Ω /0.25 W/5%/1206	RC1206JR-0715ML	Yageo	3
35	R2A, R2B, R2C	3 M Ω /0.25 W/5%/1206	RESISTOR		3
36	R9	58.3 k (0603)	RT0603DRE0758K3L		1
37	R12	820 Ω (0603)			1
38	R13	1.2 k (0603)			1
39	R14	4.3 k (0603)			1
40	R15	16 k (0603)			1
41	R21	6.2 k (0603)			1
42	R16A	2.49 k (0603)			1

Bill of materials

43	R17	51 R (1206)			1
44	R1A, R1B	1 M/200 V (1206)			2
45	TR1	ER28/14, 170 uH	750343710 (Rev 00)	Würth Electronics	1
46	ZD1	22 V/500 mW (1206)	BZS55B22 RXG	Taiwan Semiconductor	1
47	VAR	Metal Oxide Varistor (MOV), 32 J	B72207S2321K101	Epcos	1
48	CN1	Connector_ Con (L N)	691102710002	Würth Electronics	1
49	CN2, CN33	Connector_ Con (+12 V com), con(+5 V com)	691 412 120 002B	Würth Electronics	2
50	HS3	Heatsink	577202B00000G	AAVID	1
51	HS1, HS2	Heatsink	513002B02500G	AAVID	2

Transformer construction

9 Transformer construction

Core and materials: ER28/14, TP4A (TDG)

Bobbin: 070-4869 (9-pin EXT, THT, horizontal version)

Primary inductance: $L_p = 170 \mu\text{H}$ ($\pm 10\%$), measured between pin 4 and pin 6

Manufacturer and part number: Würth Electronics Midcom (750343710 Rev 00)

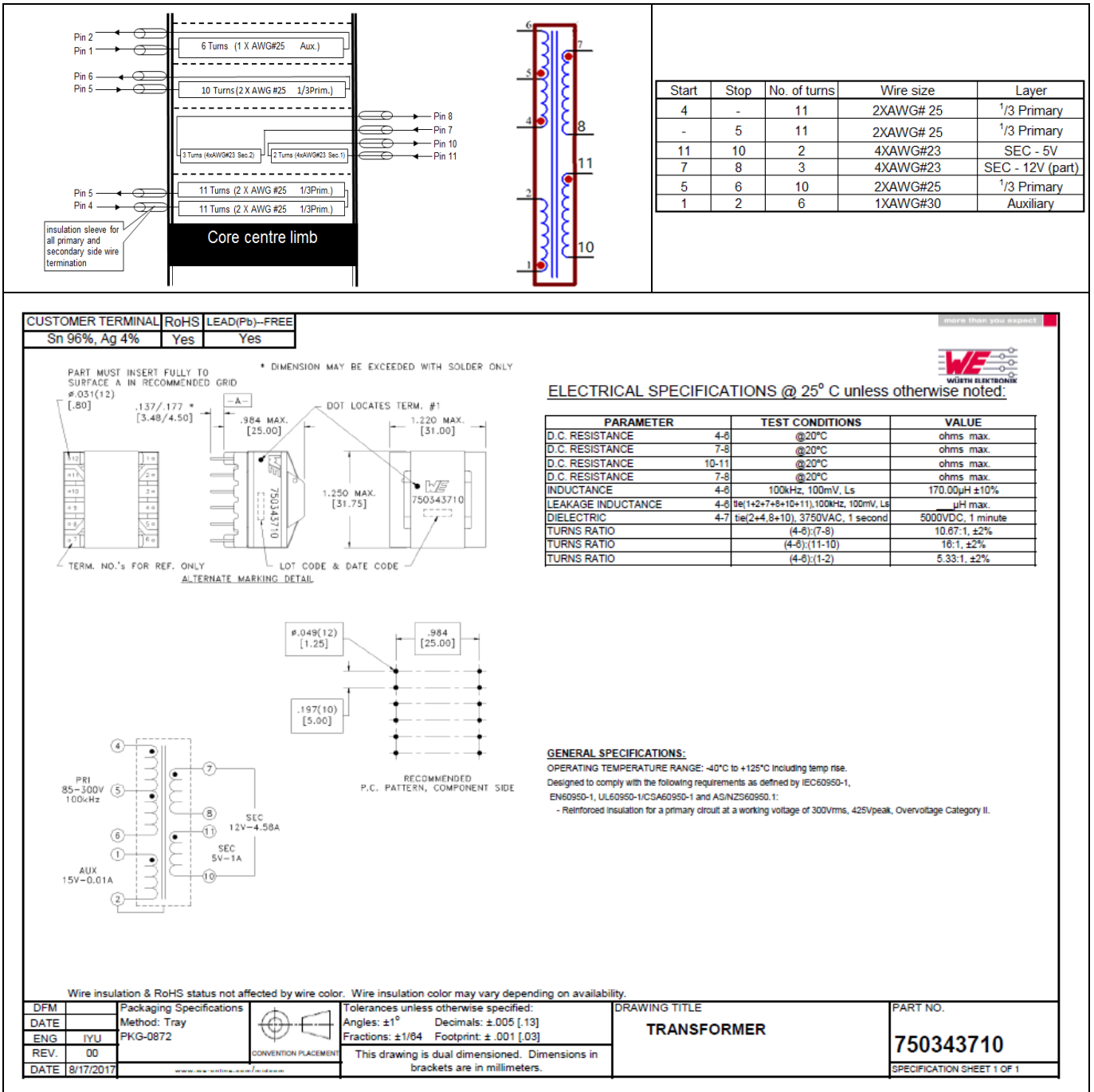

Figure 7 Transformer structure

Test results

10 Test results

10.1 Efficiency, regulation and output ripple

Table 4 Efficiency, regulation and output ripple

Input (V AC/Hz)	P _{in} (W)	12 V (V)	I _{out_12V} (mA)	5 V (V)	I _{out_5V} (mA)	12 V _{RPP} (mV)	5 V _{RPP} (mV)	P _{out} (W)	Efficiency (η) (%)	Average η (%)	OLP pin (W)	OLP I _{out12V} (fixed 5 V at 1 A) (A)
85 V AC/ 60 Hz	0.049	12.46	0	4.82	0	66	27				116	7.18
	0.120	12.38	5	4.85	0	80	20	0.06				
	18.61	12.43	1145	4.83	250	66	30	15.44	82.97	81.35		
	37.64	12.43	2290	4.83	500	76	33	30.88	82.04			
	57.17	12.43	3435	4.82	750	80	37	46.31	81.01			
	77.80	12.43	4580	4.82	1000	93	43	61.75	79.37			
115 V AC/ 60 Hz	0.054	12.46	0	4.83	0	70	28				115	7.5
	0.125	12.38	5	4.86	0	80	22	0.06				
	18.19	12.44	1145	4.83	250	66	30	15.45	84.94	83.25		
	37.00	12.43	2290	4.82	500	73	35	30.87	83.45			
	56.00	12.43	3435	4.82	750	80	37	46.31	82.70			
	75.37	12.43	4580	4.82	1000	86	40	61.75	81.93			
230 V AC/ 50 Hz	0.088	12.45	0	4.83	0	73	30				120	7.9
	0.159	12.38	5	4.86	0	83	22	0.06				
	18.48	12.44	1145	4.83	250	70	28	15.45	83.61	83.85		
	36.78	12.43	2290	4.83	500	76	33	30.88	83.96			
	55.20	12.43	3435	4.83	750	83	37	46.32	83.91			
	73.58	12.43	4580	4.82	1000	90	40	61.75	83.92			
265 V AC/ 50 Hz	0.103	12.45	0	4.83	0	73	30				122	8.08
	0.176	12.38	5	4.86	0	83	23	0.06				
	18.57	12.44	1145	4.83	250	70	28	15.45	83.21	83.72		
	36.88	12.44	2290	4.83	500	76	33	30.90	83.79			
	55.26	12.44	3435	4.84	750	83	37	46.36	83.90			
	73.53	12.43	4580	4.82	1000	86	38	61.75	83.98			
300 V AC/ 50 Hz	0.124	12.43	0	4.83	0	76	30				125	8.18
	0.196	12.34	5	4.87	0	86	25	0.06				
	18.66	12.43	1145	4.83	250	73	28	15.44	82.74	83.47		
	36.97	12.44	2290	4.82	500	76	32	30.90	83.57			
	55.32	12.43	3435	4.82	750	83	35	46.31	83.72			
	73.64	12.43	4580	4.82	1000	93	40	61.75	83.85			

60 mW load condition: 12 V @ 5 mA and 5 V @ 0 mA

Maximum load condition: 5 V @ 1000 mA and 12 V @ 4580 mA

Test results

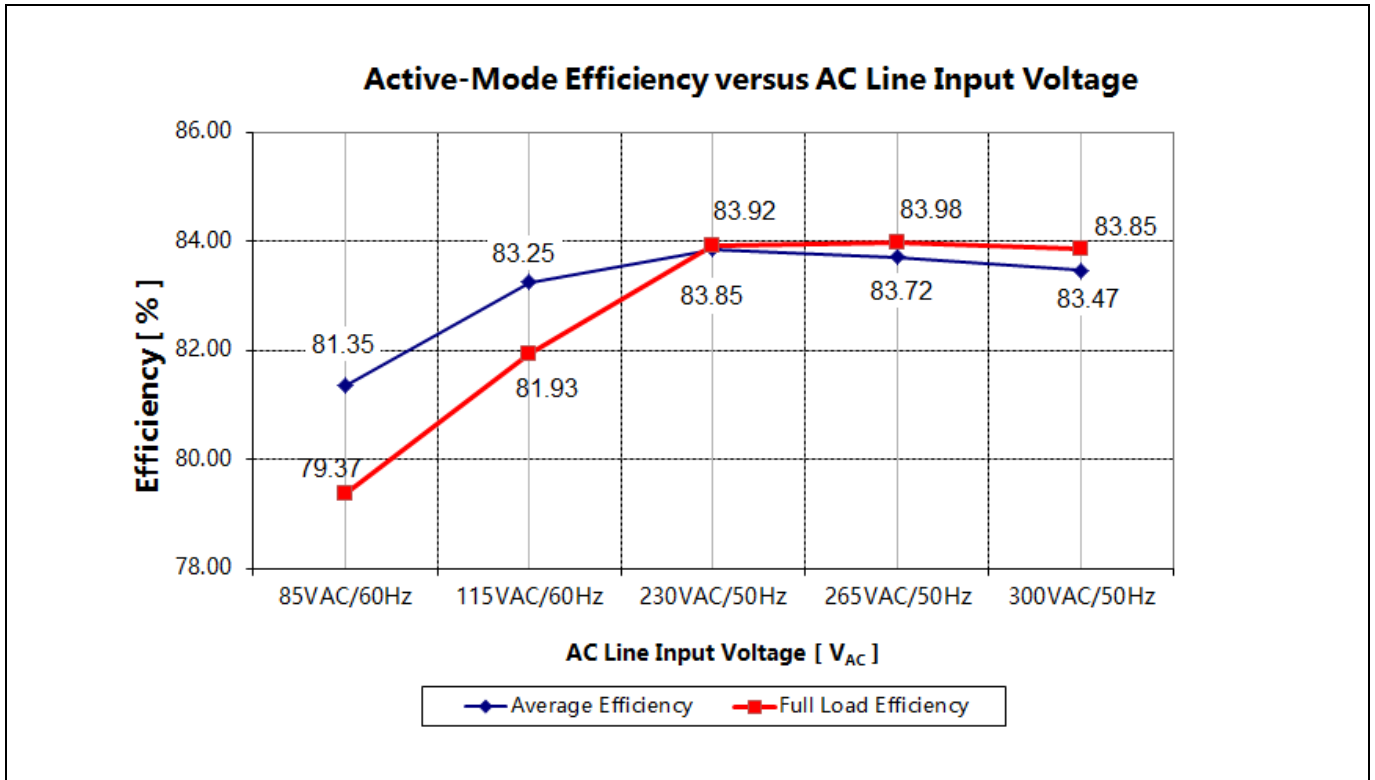

Figure 8 Efficiency vs AC-line input voltage

10.2 Standby power

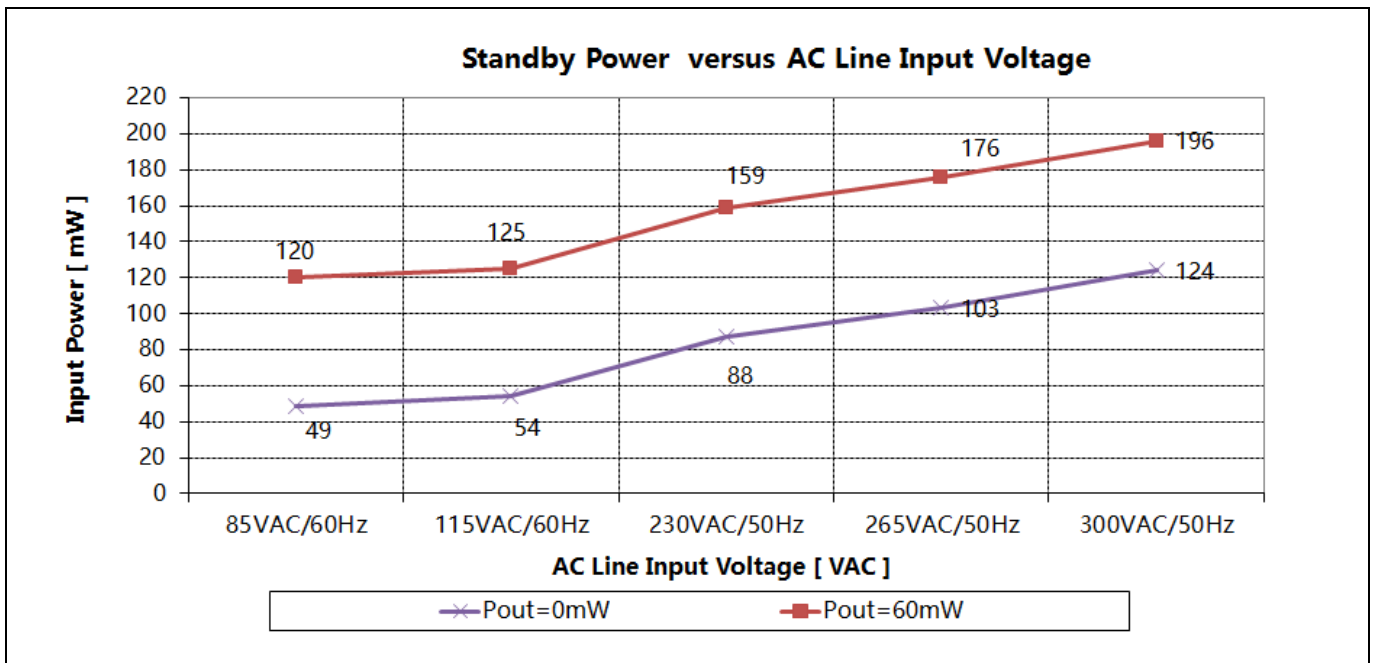

Figure 9 Standby power at no load and 60 mW load vs AC-line input voltage (measured by Yokogawa WT210 power meter – integration mode)

Test results

10.3 Line regulation

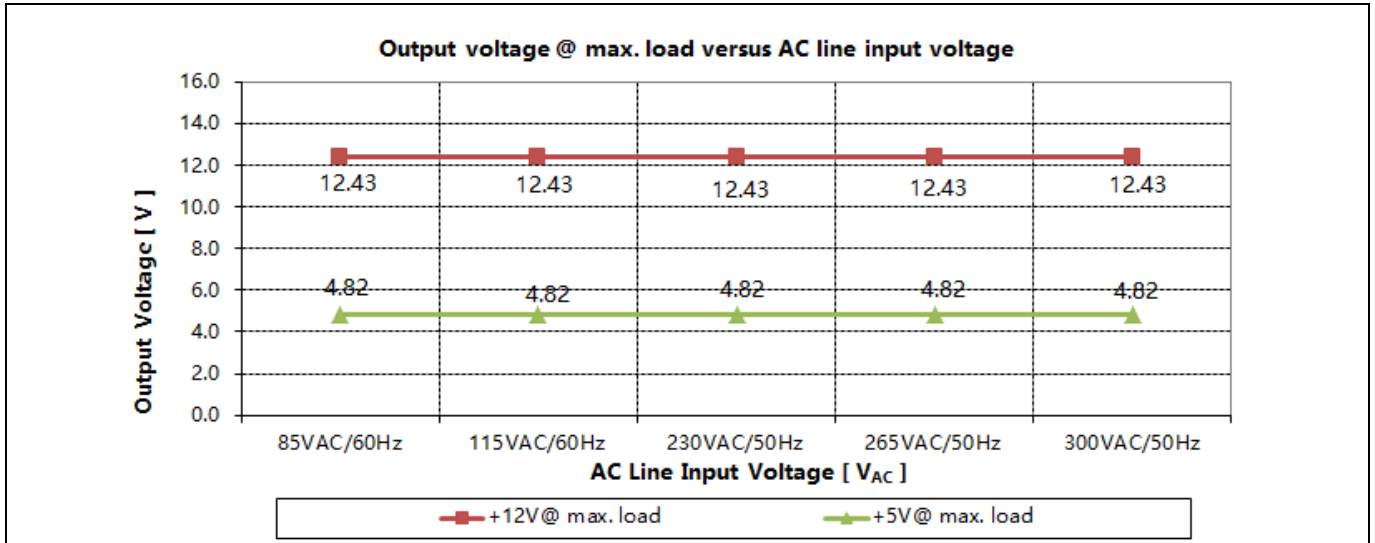

Figure 10 Line regulation V_{out} at full load vs AC-line input voltage

10.4 Load regulation

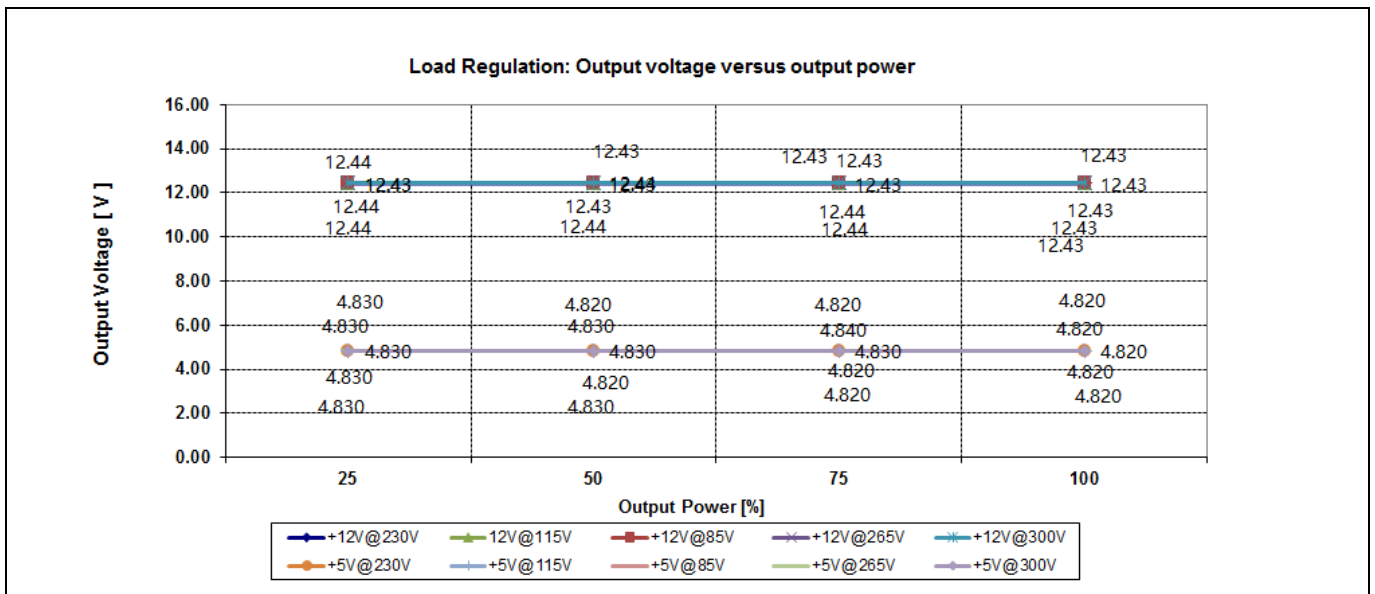

Figure 11 Load regulation V_{out} vs output power

Test results

10.5 Maximum input power

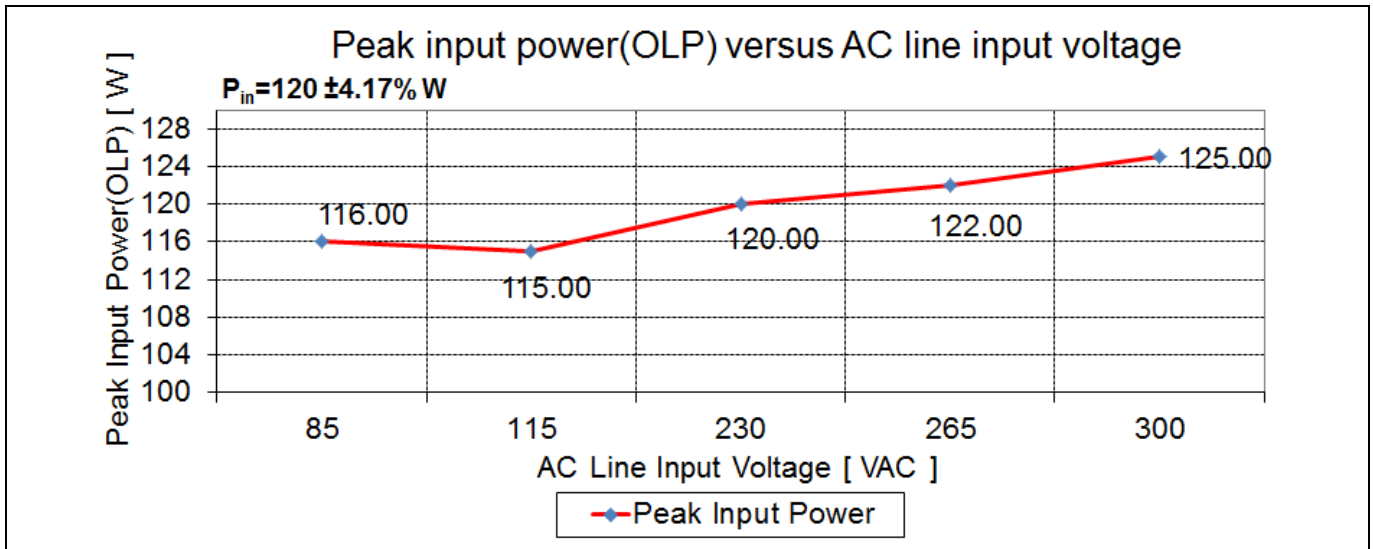

Figure 12 Maximum input power (before over-load protection) vs AC-line input voltage

10.6 ESD immunity (EN 61000-4-2)

Pass EN 61000-4-2 level 4 for contact discharge and level 3 for air discharge (± 8 kV for both contact and air discharge).

10.7 Surge immunity (EN 61000-4-5)

Pass EN 61000-4-5 installation class 4 (± 2 kV for line-to-line and ± 4 kV for line-to-earth).

10.8 Conducted emissions (EN 55022 class B)

The conducted EMI was measured by Schaffner (SMR4503) and followed the test standard of EN 55022 (CISPR 22) class B. The demo board was set up at full load (60 W) with input voltage of 115 V AC and 230 V AC.

Pass conducted emissions EN 55022 (CISPR 22) class B with 6 dB margin at low-line (115 V AC) and with 6 dB margin for high-line (230 V AC).

Test results

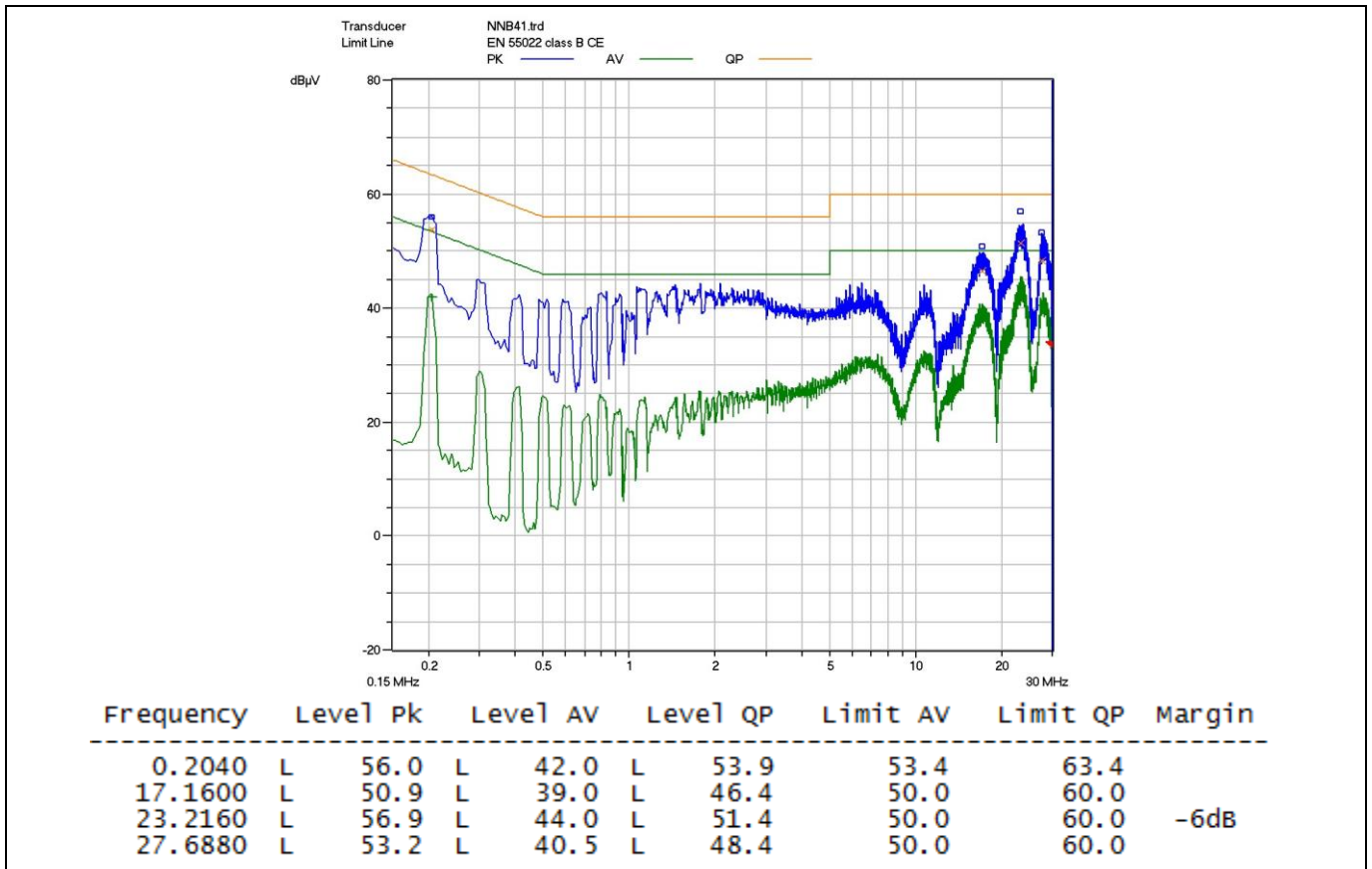

Figure 13 Conducted emissions (line) at 115 V AC and maximum load

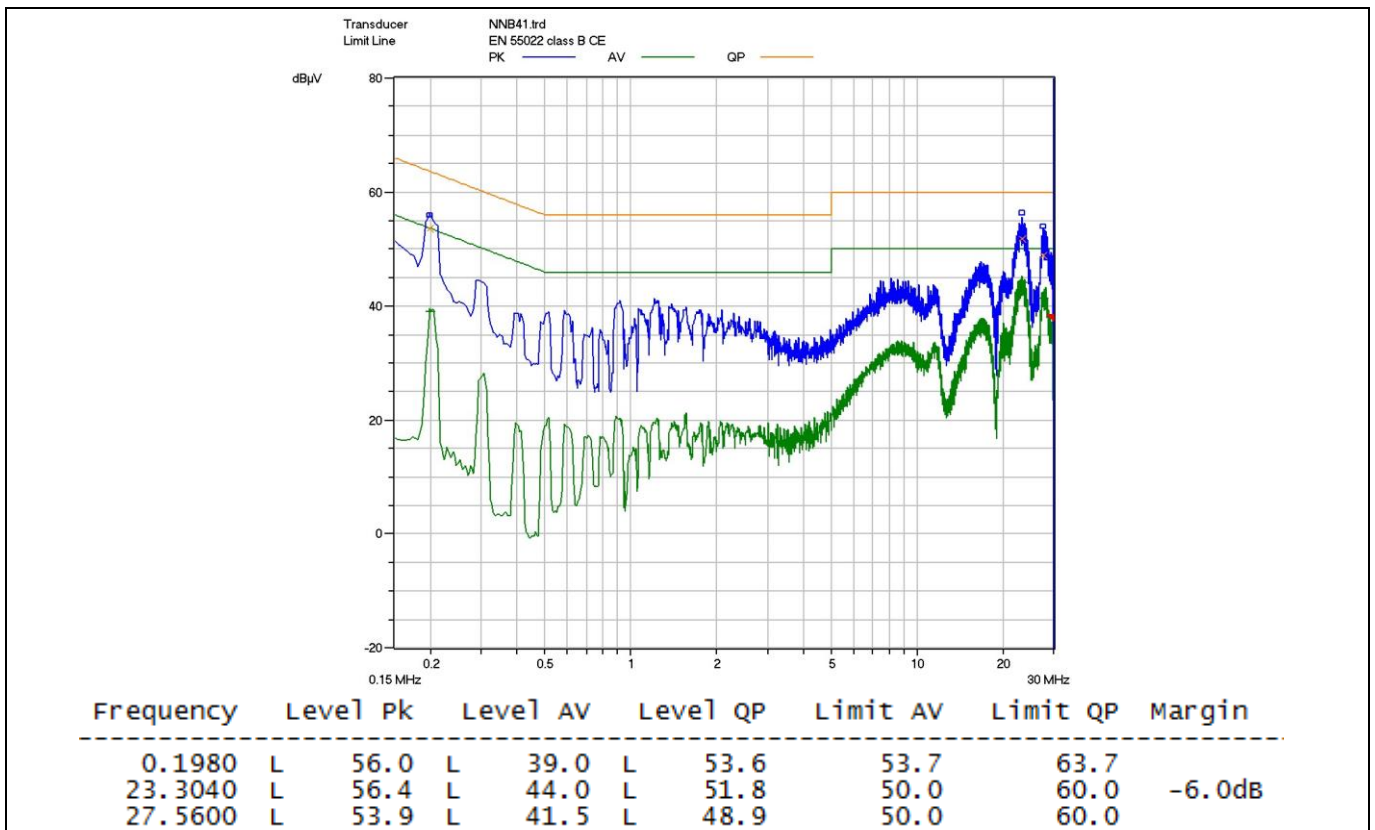

Figure 14 Conducted emissions (neutral) at 115 V AC and maximum load

Test results

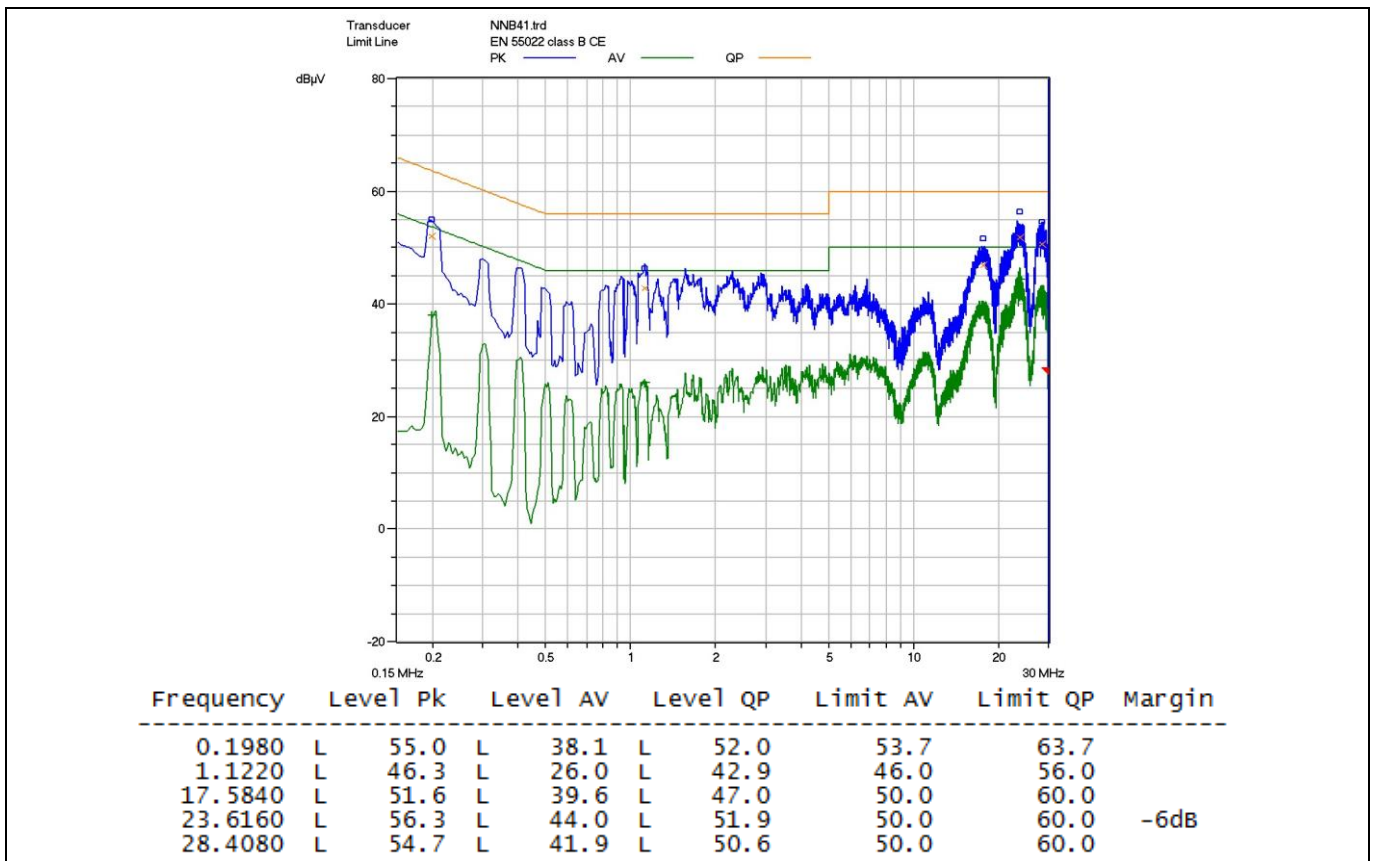

Figure 15 Conducted emissions (line) at 230 V AC and maximum load

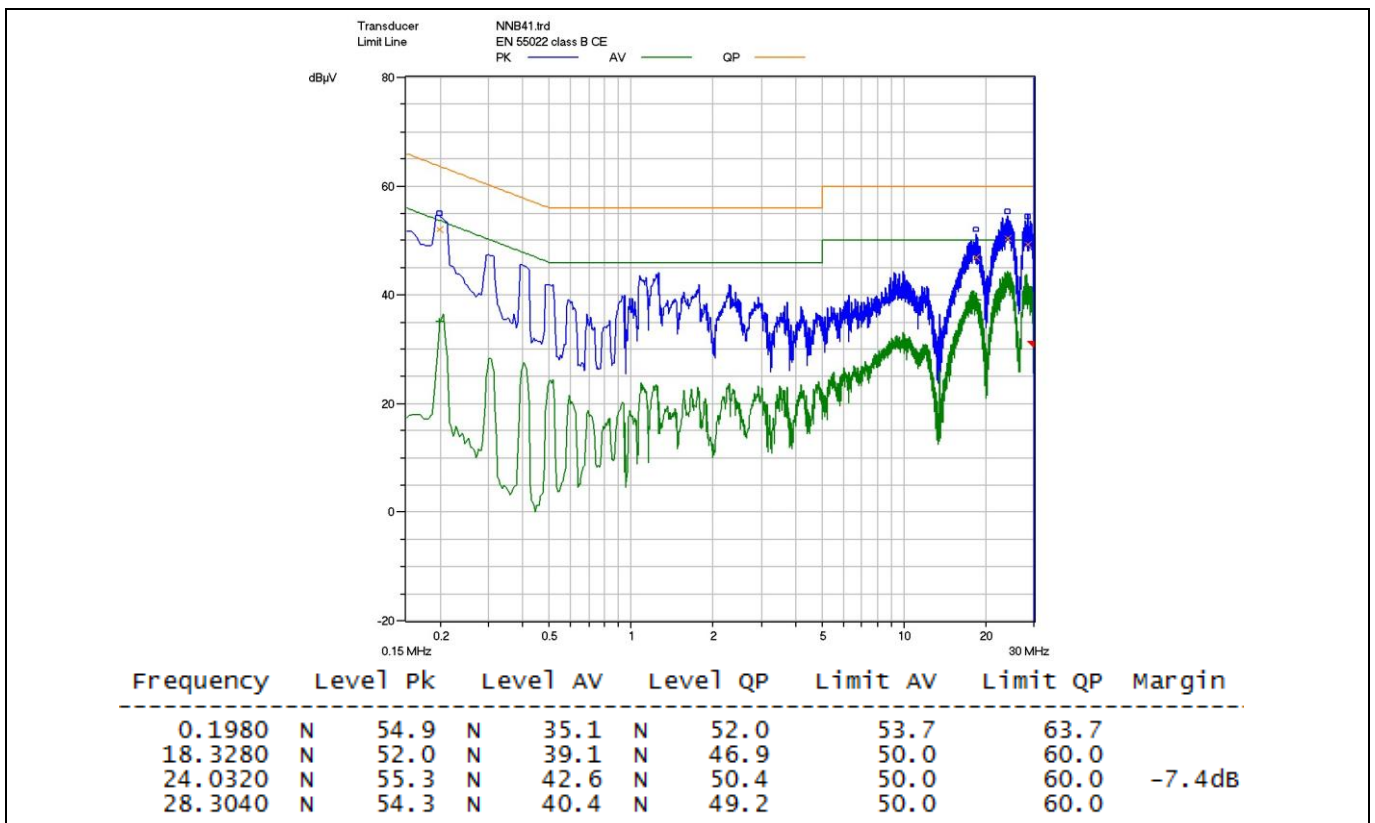

Figure 16 Conducted emissions (neutral) at 230 V AC and maximum load

Test results

10.9 Thermal measurements

The thermal testing of the open-frame demo board was done using an infrared thermography camera (FLIR-T62101) at an ambient temperature of 25°C. The measurements were taken after one hour running at full load.

Table 5 Hottest temperature of demo board

No.	Major component	85 V AC (°C)	300 V AC (°C)
1	IC1 (ICE5ASAG)	81.9	55.4
2	Q1 (IPA80R600P7)	43.2	38.4
3	TR1 (transformer)	72.5	71.9
4	D4 (12 V diode)	84.8	80.0

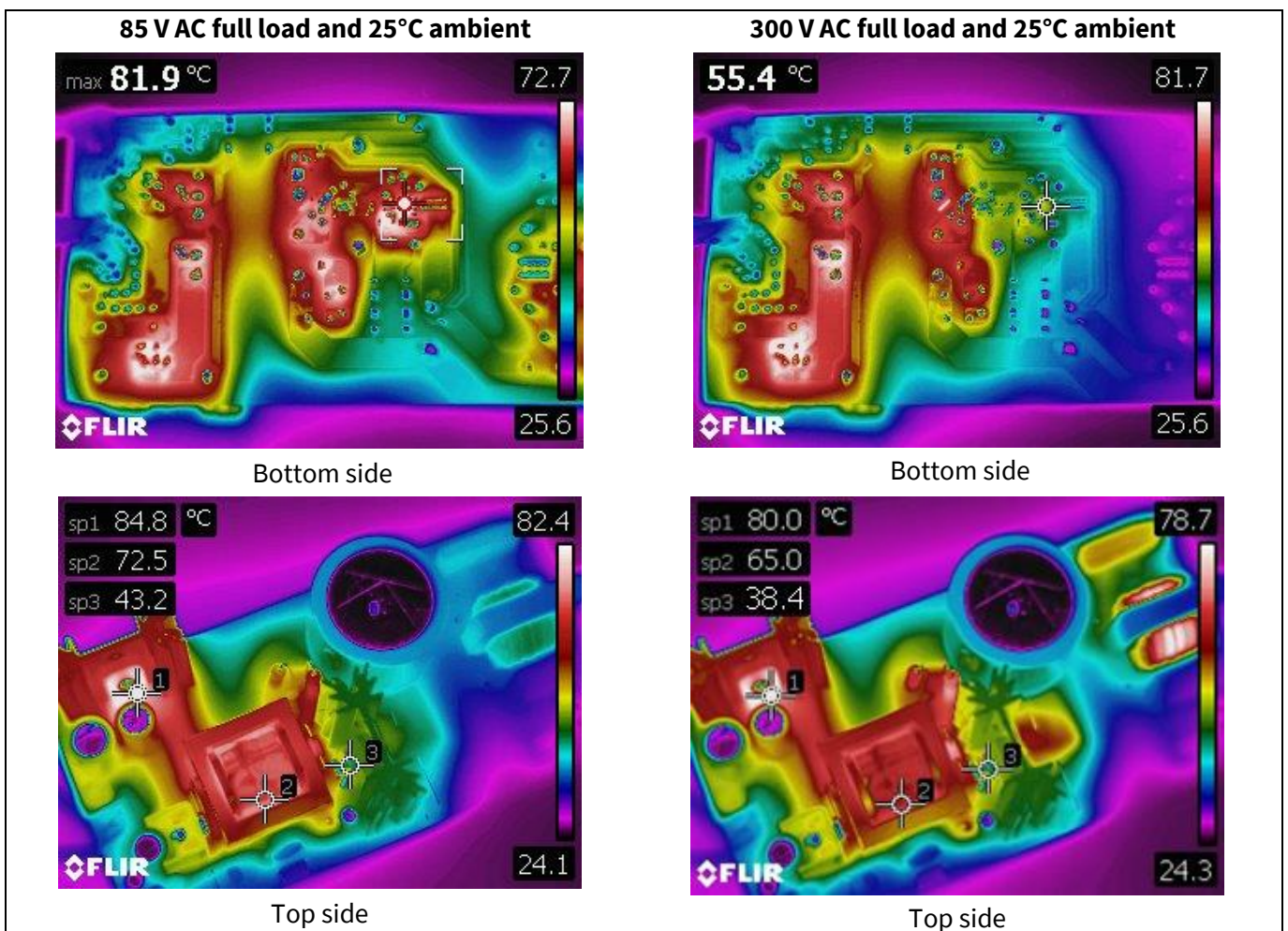

Figure 17 Infrared thermal image of DEMO_5ASAG_60W1

Waveforms and scope plots

11 Waveforms and scope plots

All waveforms and scope plots were recorded with a Teledyne LeCroy 606Zi oscilloscope.

11.1 Start-up at low/high AC-line input voltage with maximum load

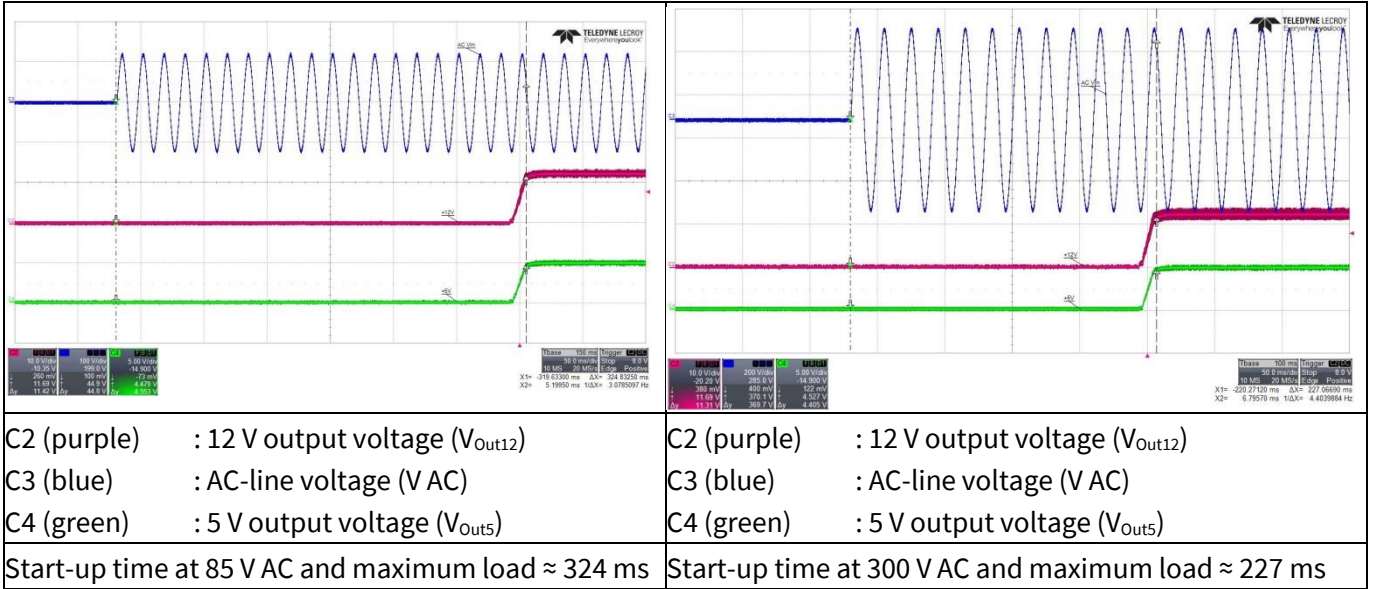

Figure 18 Start-up

11.2 Soft-start

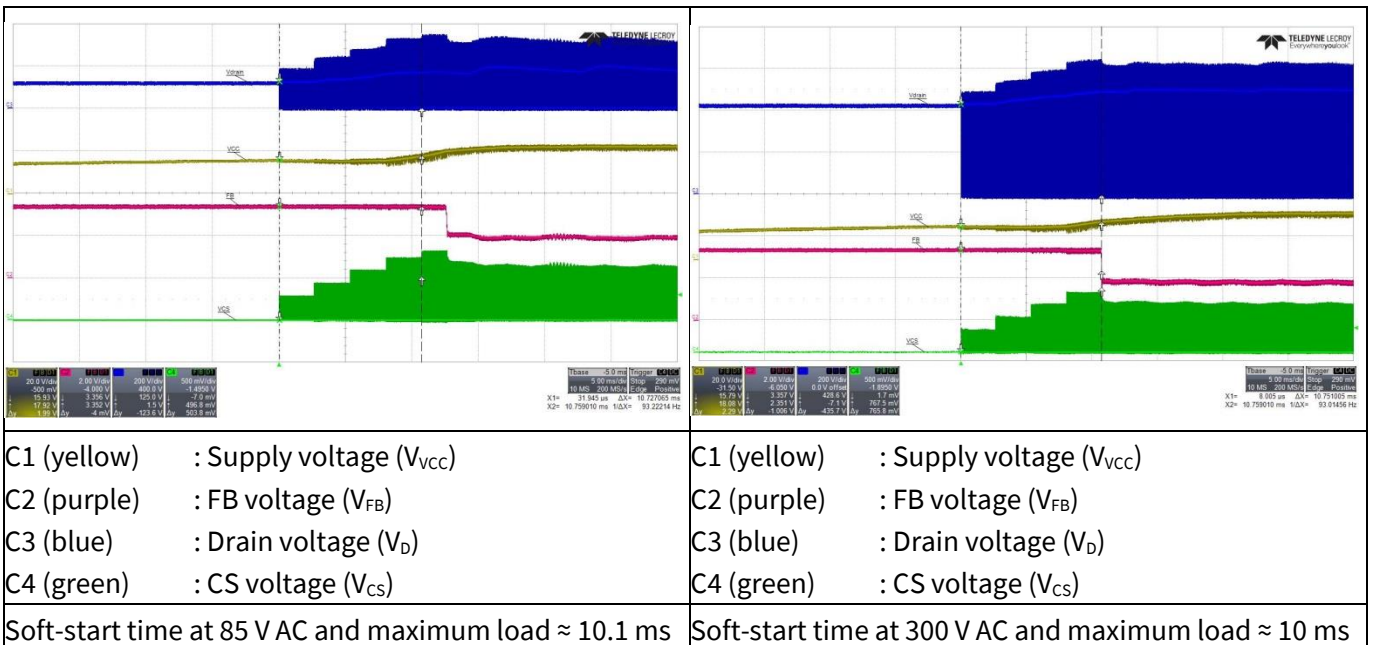

Figure 19 Soft-start

Waveforms and scope plots

11.3 Drain and CS voltage at maximum load

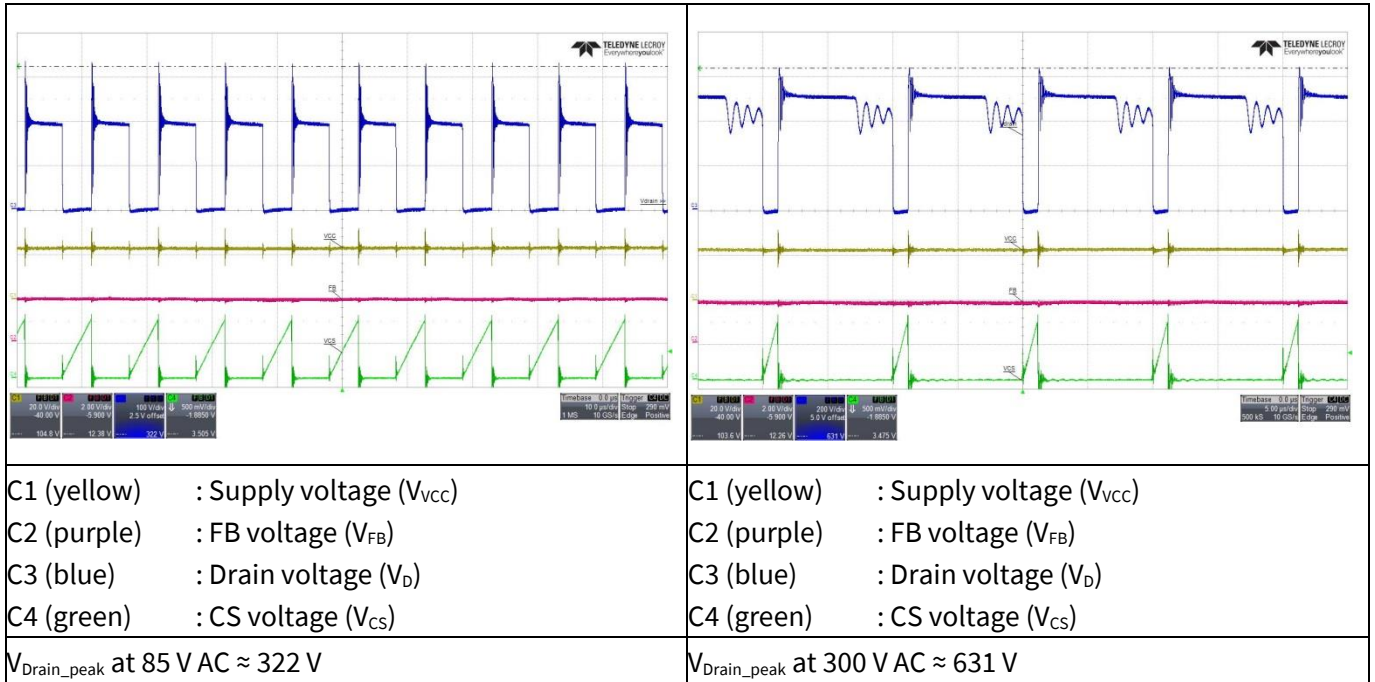

Figure 20 Drain and CS voltage at maximum load

11.4 Frequency jittering

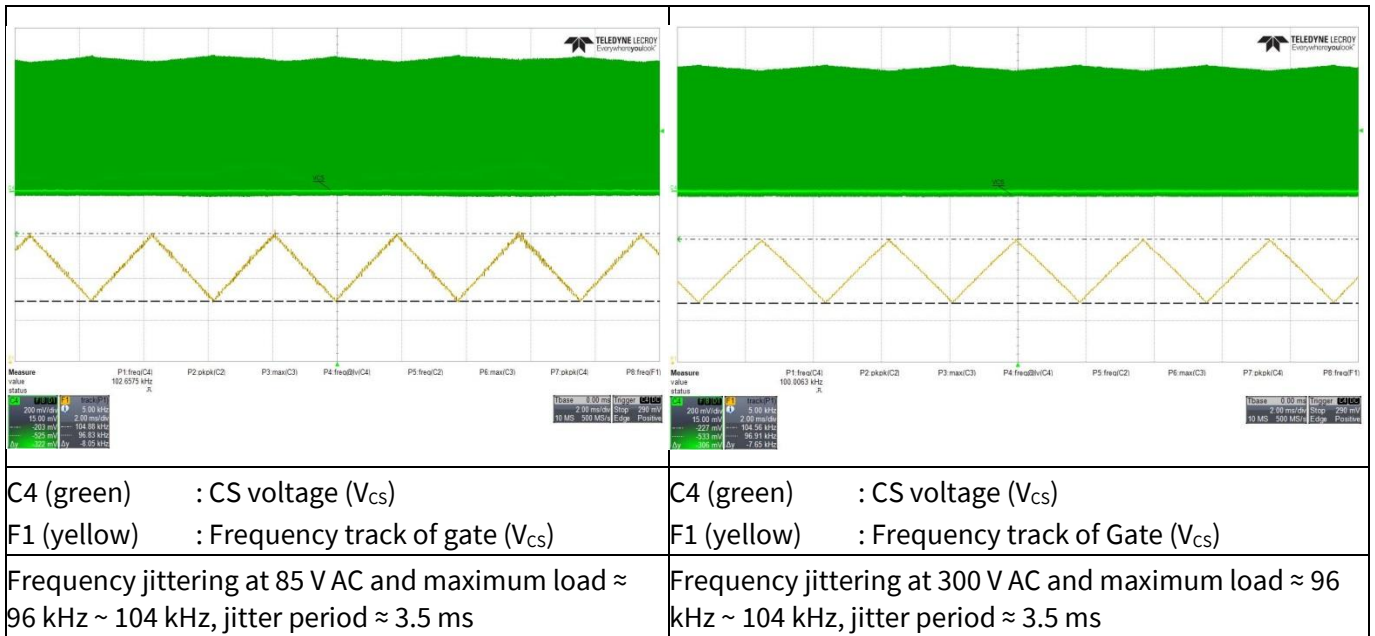

Figure 21 Frequency jittering

Waveforms and scope plots

11.5 Load transient response (dynamic load from 10% to 100%)

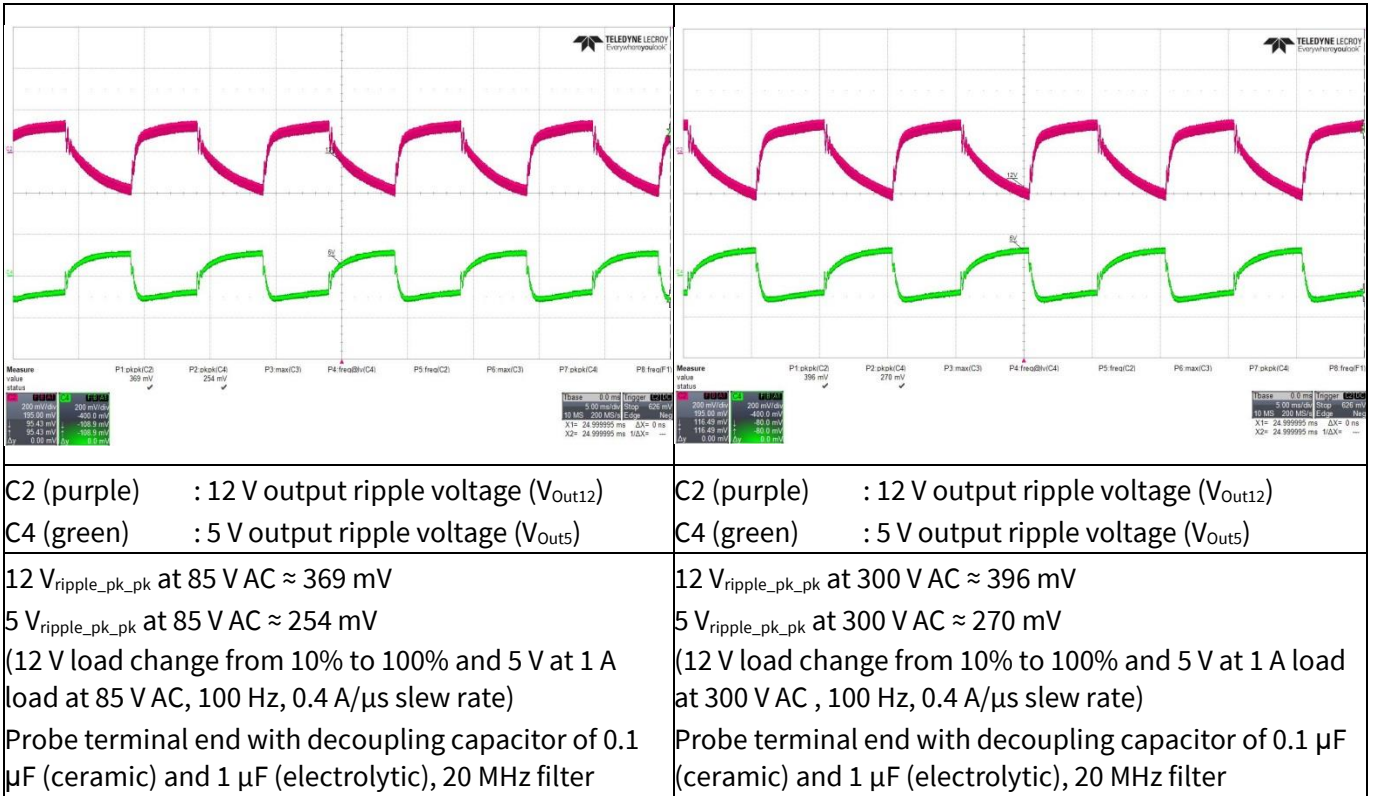

Figure 22 Load transient response

11.6 Output ripple voltage at maximum load

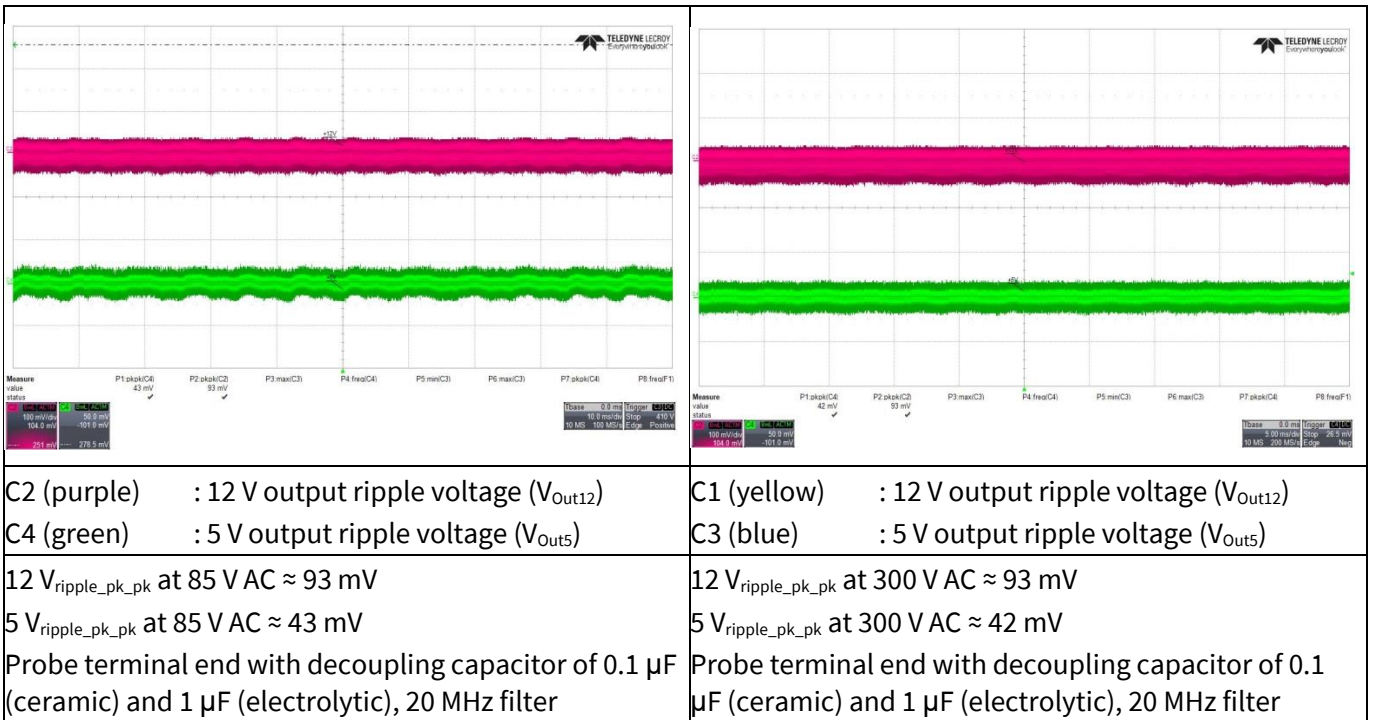

Figure 23 Output ripple voltage at maximum load

Waveforms and scope plots

11.7 Output ripple voltage at ABM 1 W load

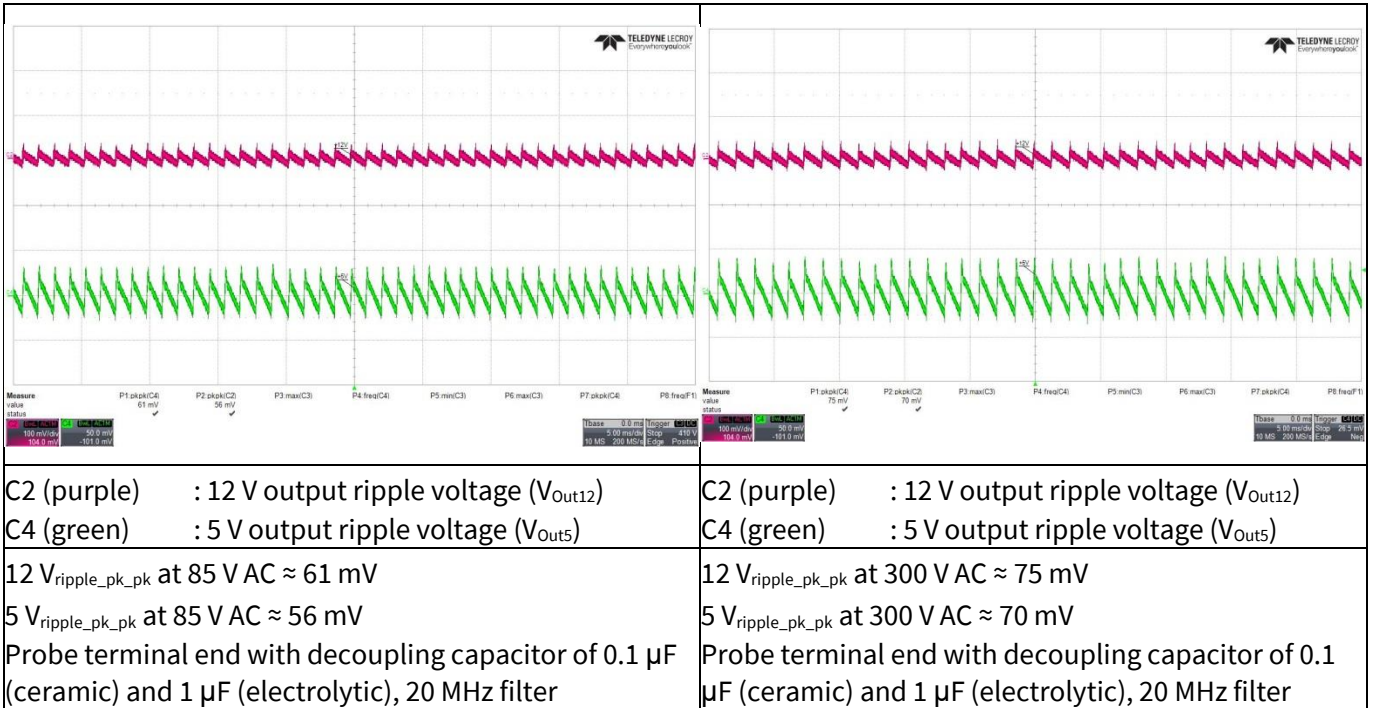

Figure 24 Output ripple voltage at ABM 1 W load

11.8 Entering ABM

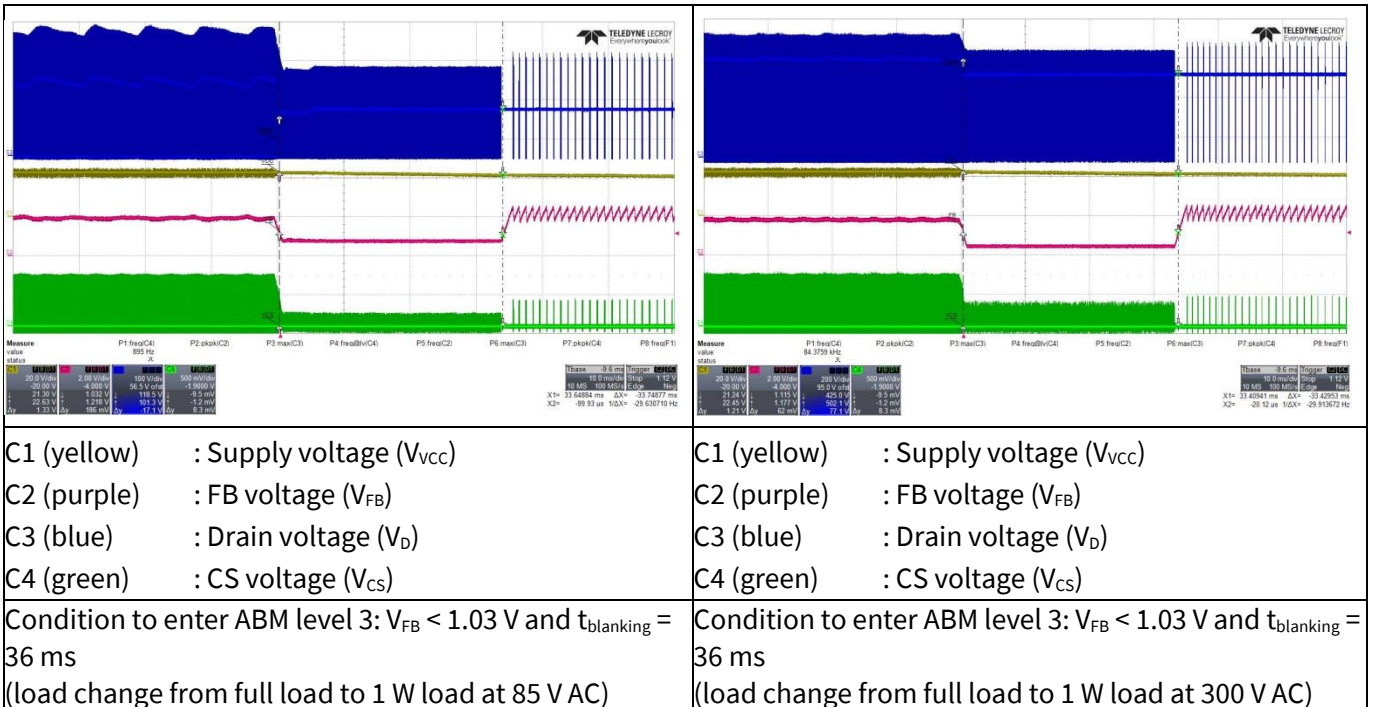

Figure 25 Entering ABM

Waveforms and scope plots

11.9 During ABM

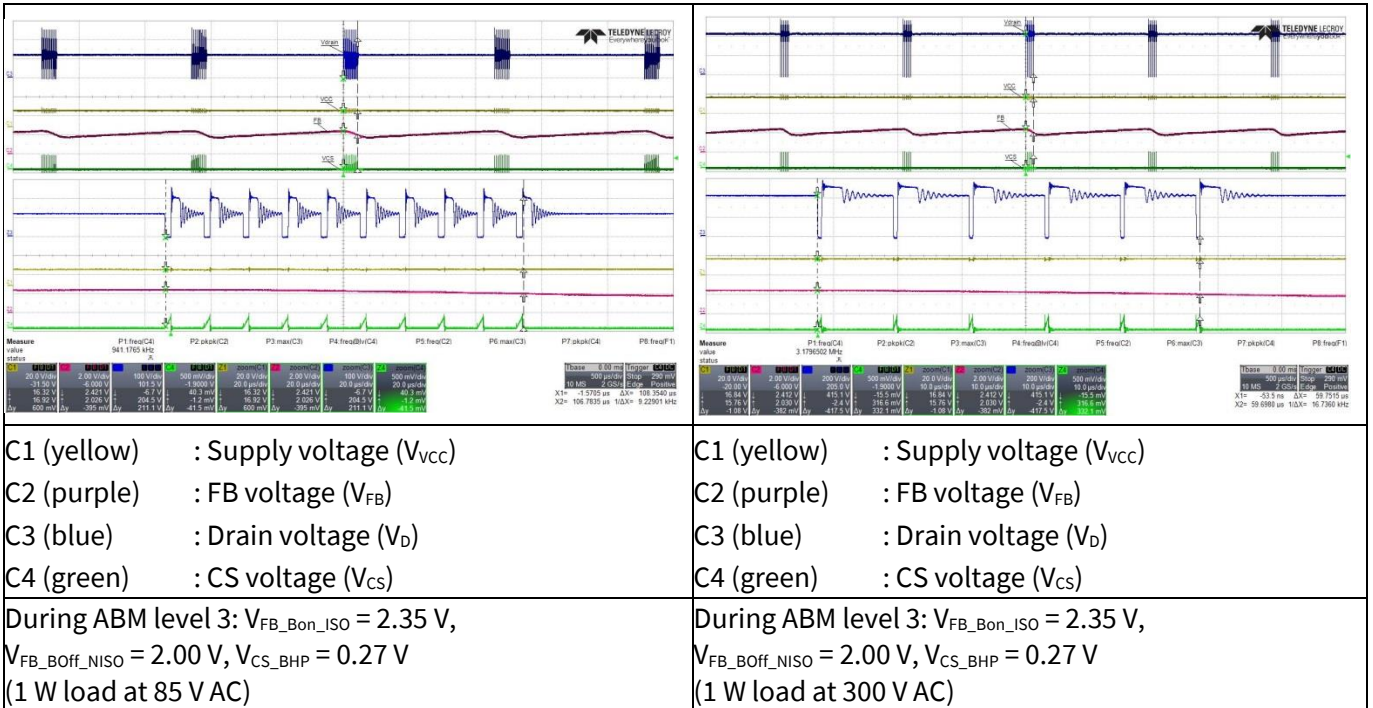

Figure 26 During ABM

11.10 Leaving ABM

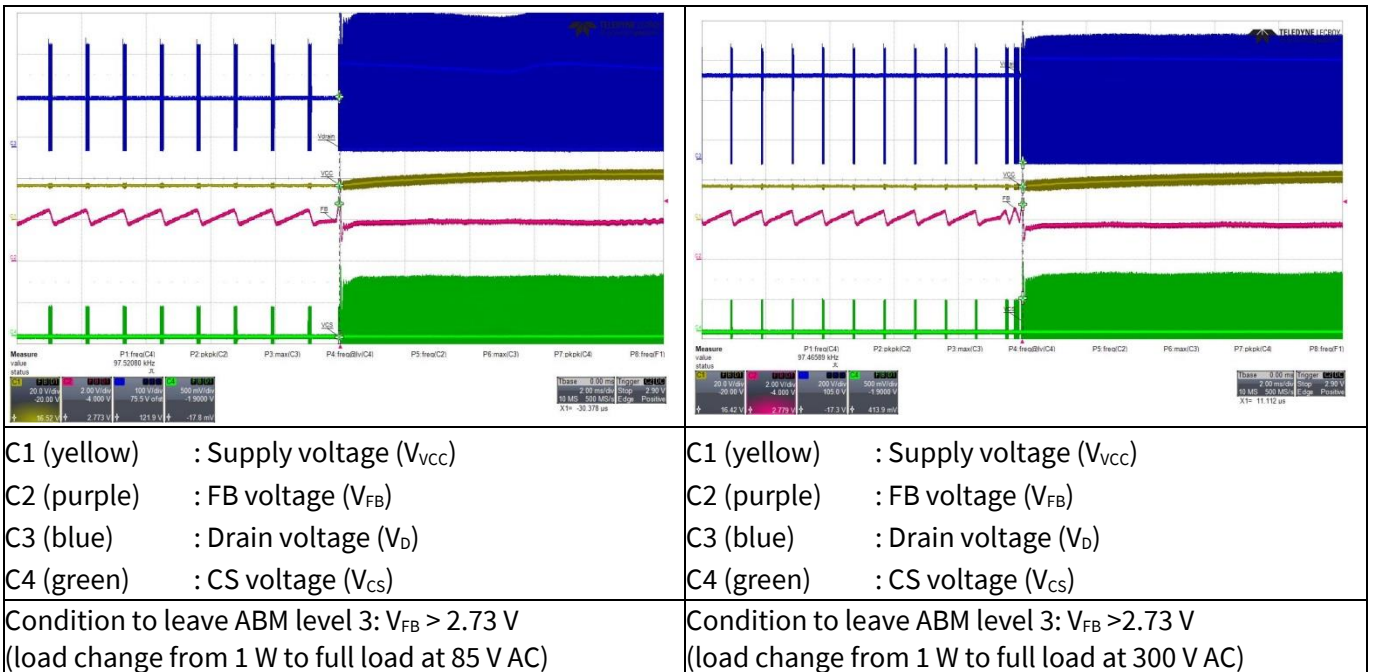

Figure 27 Leaving ABM

Waveforms and scope plots

11.11 Line OVP (non-switch auto restart)

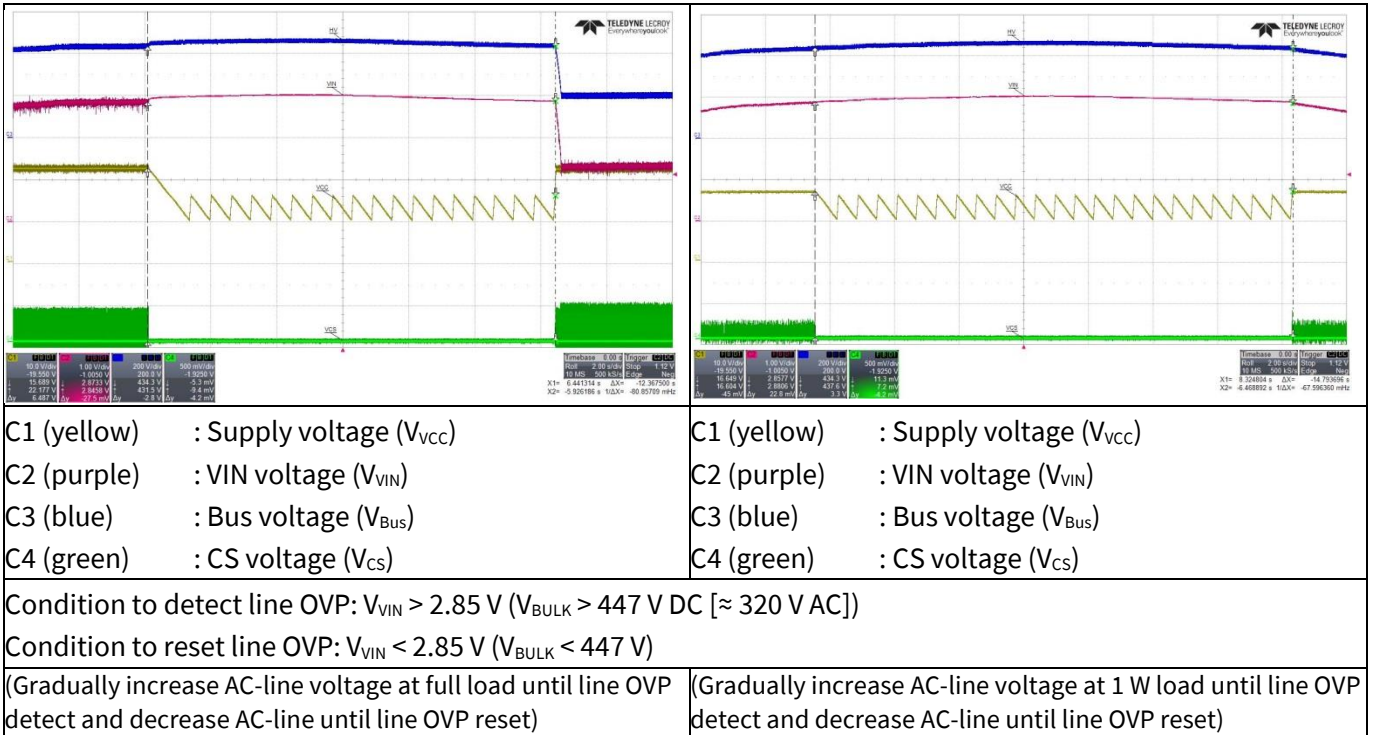

Figure 28 Line OVP

11.12 V_{CC} OVP (odd-skip auto restart)

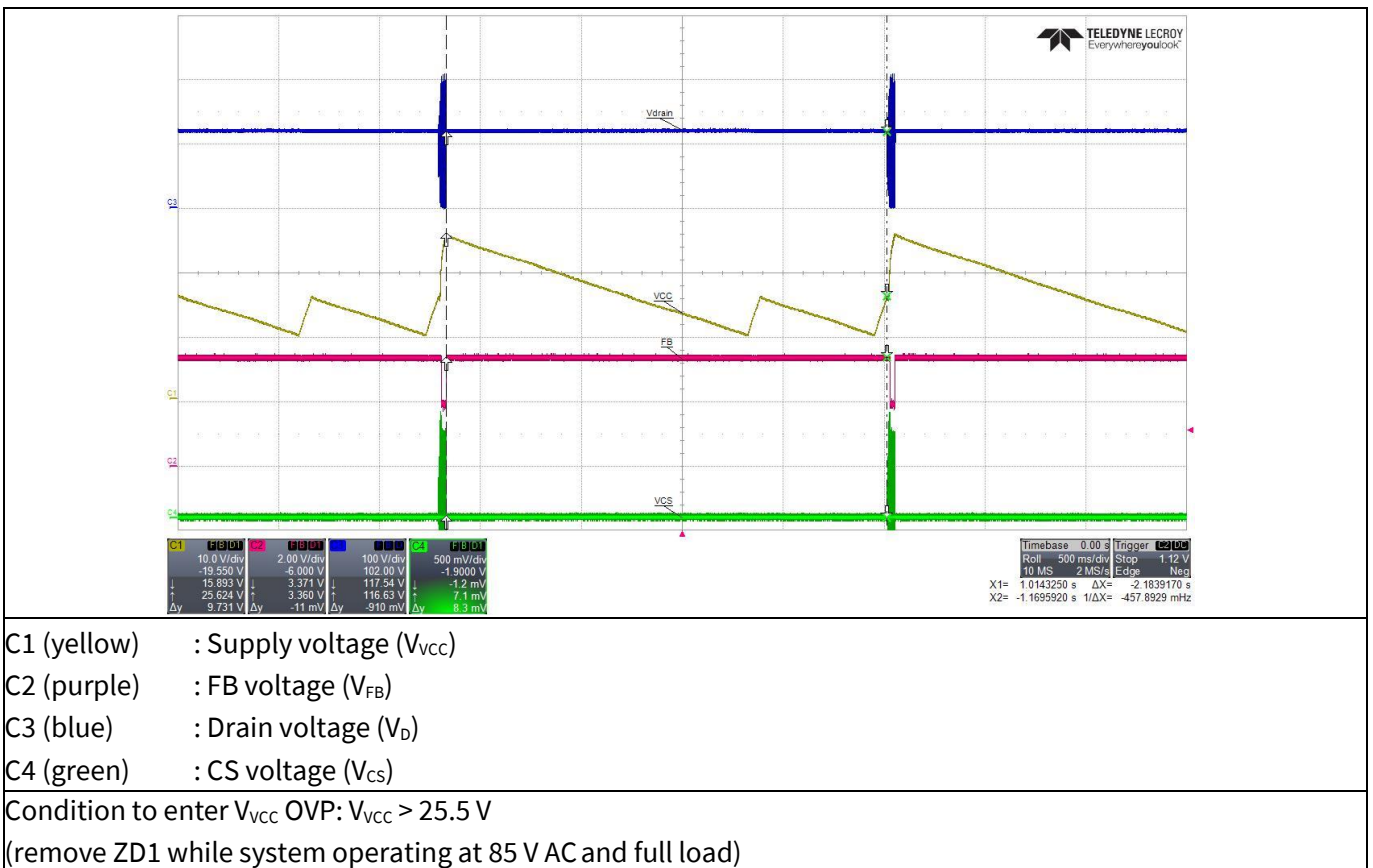
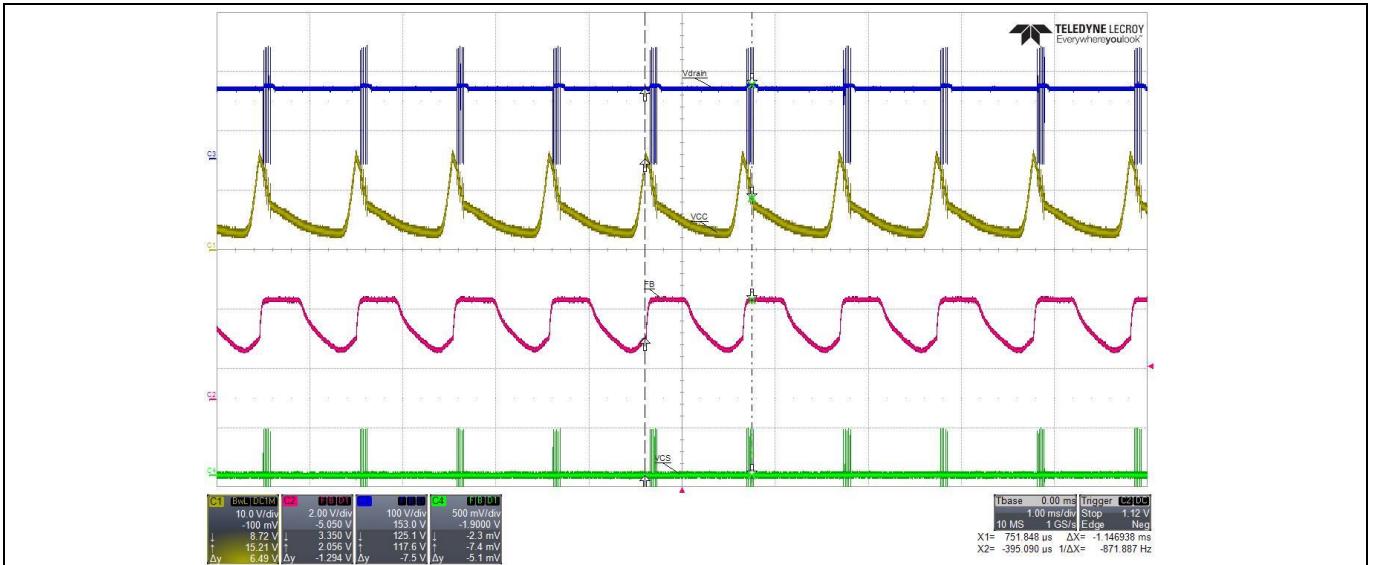

Figure 29 V_{CC} OVP

Waveforms and scope plots

11.13 V_{CC} UV protection (auto restart)



- C1 (yellow) : Supply voltage (V_{CC})
- C2 (purple) : FB voltage (V_{FB})
- C3 (blue) : Drain voltage (V_D)
- C4 (green) : CS voltage (V_{CS})

Condition to enter V_{CC} UV protection: V_{CC} < 10 V
 (Remove R5 and C3 then power on the system with full load at 85 V AC)

Figure 30 V_{CC} UV protection

11.14 Over-load protection (odd-skip auto restart)

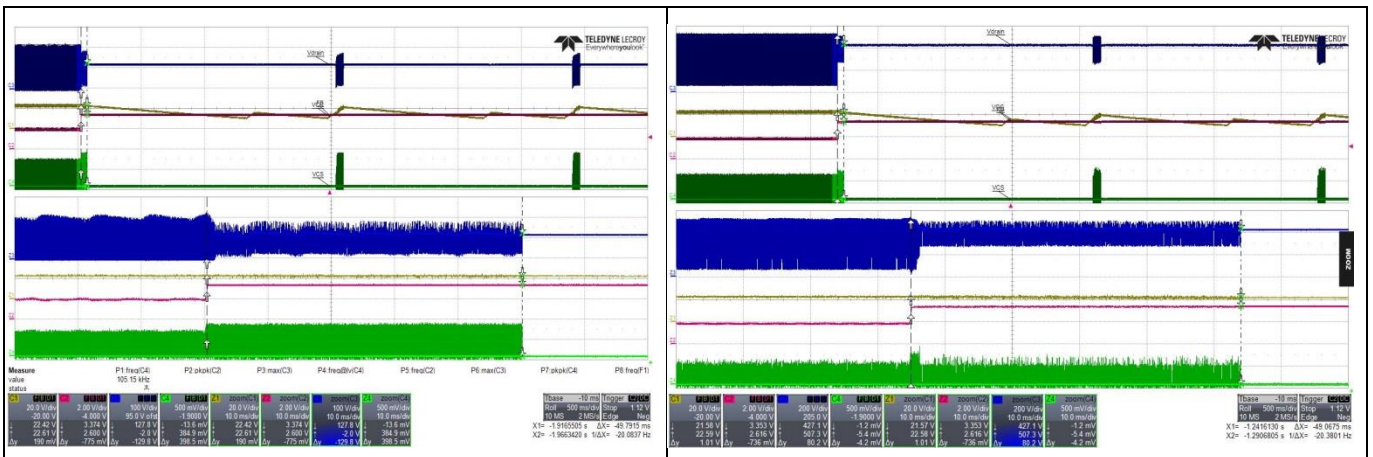

- C1 (yellow) : Supply voltage (V_{CC})
- C2 (purple) : FB voltage (V_{FB})
- C3 (blue) : Drain voltage (V_D)
- C4 (green) : CS voltage (V_{CS})

Condition to enter over-load protection: V_{FB} > 2.73 V
 and lasts for 54 ms blanking time
 (12 V output load change from full to short at 85 V AC)

- C1 (yellow) : Supply voltage (V_{CC})
- C2 (purple) : FB voltage (V_{FB})
- C3 (blue) : Drain voltage (V_D)
- C4 (green) : CS voltage (V_{CS})

Condition to enter over-load protection: V_{FB} > 2.73 V
 and lasts for 54 ms blanking time
 (12 V output load change from full to short at 300 V AC)

Figure 31 Over-load protection

Waveforms and scope plots

11.15 V_{CC} short-to-GND protection

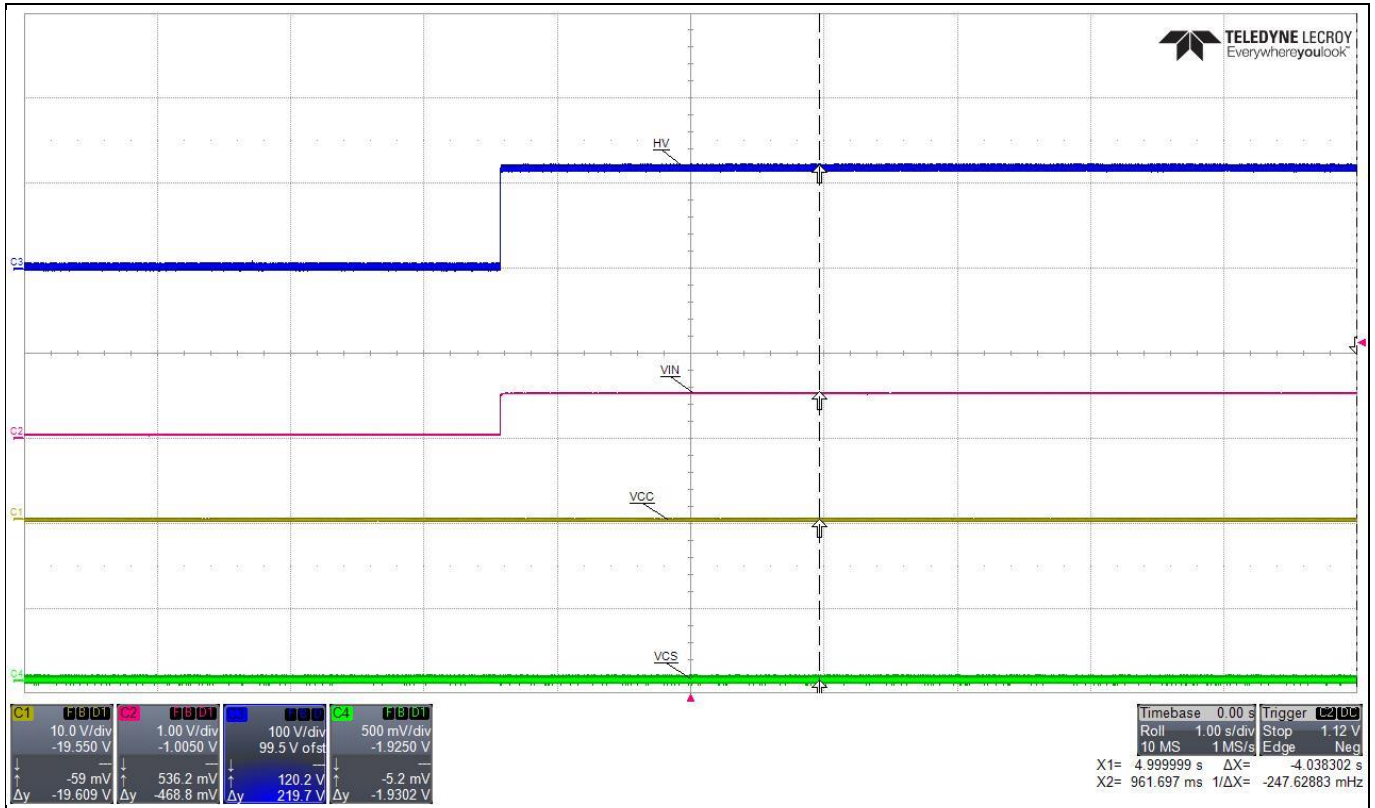

- C1 (yellow) : Supply voltage (V_{CC})
- C2 (purple) : VIN voltage (V_{VIN})
- C3 (blue) : Bus voltage (V_{Bus})
- C4 (green) : CS voltage (V_{CS})

Condition to enter V_{CC} short-to-GND: if $V_{CC} < V_{VCC_SCP}$ → $V_{CC} = I_{VCC_charge1}$
 (short V_{CC} pin-to-GND and measure the current with multimeter before system start-up, I_{VCC} ≈ 277 μA at 85 V AC)

Figure 32 V_{CC} short-to-GND protection

References

12 References

- [1] [ICE5xSAG datasheet, Infineon Technologies AG](#)
- [2] [5th Generation fixed-frequency Design Guide](#)
- [3] [Calculation Tool fixed-frequency CoolSET™ Generation 5](#)

Revision history**Revision history**

Document version	Date of release	Description of changes
1.2	2023-01-19	Editorial changes
1.1	2018-05-09	Page 12: Add C10 in BOM and change R14 from 12 Ω to 4.3 Ω Page 24, Figure 22: Correct the load condition setting Page 30: Reference [1] changed to ICE5xSAG
1.0	2018-03-21	Initial release

Trademarks

All referenced product or service names and trademarks are the property of their respective owners.

Edition 2023-01-19

Published by

Infineon Technologies AG

81726 Munich, Germany

© 2023 Infineon Technologies AG.

All Rights Reserved.

Do you have a question about this document?

Email: erratum@infineon.com

Document reference

ER_201707_PL83_014

IMPORTANT NOTICE

The information contained in this application note is given as a hint for the implementation of the product only and shall in no event be regarded as a description or warranty of a certain functionality, condition or quality of the product. Before implementation of the product, the recipient of this application note must verify any function and other technical information given herein in the real application. Infineon Technologies hereby disclaims any and all warranties and liabilities of any kind (including without limitation warranties of non-infringement of intellectual property rights of any third party) with respect to any and all information given in this application note.

The data contained in this document is exclusively intended for technically trained staff. It is the responsibility of customer's technical departments to evaluate the suitability of the product for the intended application and the completeness of the product information given in this document with respect to such application.

For further information on the product, technology, delivery terms and conditions and prices please contact your nearest Infineon Technologies office (www.infineon.com).

WARNINGS

Due to technical requirements products may contain dangerous substances. For information on the types in question please contact your nearest Infineon Technologies office.

Except as otherwise explicitly approved by Infineon Technologies in a written document signed by authorized representatives of Infineon Technologies, Infineon Technologies' products may not be used in any applications where a failure of the product or any consequences of the use thereof can reasonably be expected to result in personal injury.