

# Getting started with PSoC™ 4 MCU

## About this document

### Scope and purpose

This application note introduces you to PSoC™ 4, an Arm® Cortex®-M0/M0+ based programmable system-on-chip. It helps you explore the PSoC™ 4 architecture and development tools and explains you how to create your first project using PSoC™ Creator and ModusToolbox™, the development tools for PSoC™ 4; also guides you to more resources to accelerate in-depth learning about PSoC™ 4.

### Intended audience

This application note is intended for engineers new to PSoC™ and ModusToolbox™, and those with experience in working with embedded microcontrollers.

### Associated part family

All PSoC™ 4 parts

### Software version

PSoC™ Creator 4.4 SP2 or higher, ModusToolbox™ 3.2 or higher.

### More code examples? We heard you.

To access an ever-growing list of PSoC™ PSoC™ 4 code examples using ModusToolbox™, please visit the [GitHub](#) site. You can also explore the [PSoC™ video library](#).

## Table of contents

|          |  |    |
|----------|--|----|
|          | <b>About this document</b> .....                 | 1  |
|          | <b>Table of contents</b> .....                   | 1  |
| <b>1</b> | <b>Introduction</b> .....                        | 3  |
| <b>2</b> | <b>Development ecosystem</b> .....               | 4  |
| 2.1      | PSoC™ resources .....                            | 4  |
| 2.2      | Firmware/application development .....           | 4  |
| 2.2.1    | Installing the ModusToolbox™ tools package ..... | 5  |
| 2.2.2    | Choosing an IDE .....                            | 5  |
| 2.2.3    | ModusToolbox™ software .....                     | 7  |
| 2.2.4    | ModusToolbox™ applications .....                 | 9  |
| 2.2.5    | PSoC™ 4 software resources .....                 | 10 |
| 2.2.5.1  | Configurators .....                              | 10 |
| 2.2.5.2  | Library management for PSoC™ 4 .....             | 11 |
| 2.2.5.3  | Software development for PSoC™ 4 .....           | 11 |
| 2.2.6    | ModusToolbox™ help .....                         | 12 |
| 2.3      | Support for other IDEs .....                     | 13 |
| 2.4      | PSoC™ Creator .....                              | 13 |
| 2.4.1    | PSoC™ Creator help .....                         | 14 |
| 2.5      | Technical support .....                          | 14 |
| <b>3</b> | <b>PSoC™ 4 feature set</b> .....                 | 15 |

---

## Table of contents

|          |  |    |
|----------|--|----|
| <b>4</b> | <b>PSoC™ is more than an MCU</b> .....                   | 23 |
| 4.1      | The concept of PSoC™ Creator Components .....            | 24 |
| <b>5</b> | <b>Getting started with PSoC™ 4 design</b> .....         | 25 |
| 5.1      | Prerequisites .....                                      | 25 |
| 5.1.1    | Hardware .....   | 25 |
| 5.1.2    | Software .....   | 25 |
| 5.2      | Using these instructions .....                           | 25 |
| 5.3      | About the design .....                                   | 26 |
| 5.4      | Create a BSP for your board .....                        | 26 |
| 5.5      | Create a new application .....                           | 26 |
| 5.6      | View and modify the design configuration .....           | 30 |
| 5.6.1    | Opening the Device Configurator .....                    | 32 |
| 5.7      | Write firmware .....                                     | 36 |
| 5.8      | Build the application .....                              | 41 |
| 5.9      | Program the device .....                                 | 42 |
| 5.10     | Test your design .....                                   | 44 |
| <b>6</b> | <b>My first PSoC™ 4 design using PSoC™ Creator</b> ..... | 47 |
| 6.1      | Before you begin .....                                   | 47 |
| 6.1.1    | Have you installed PSoC™ Creator? .....                  | 47 |
| 6.1.2    | Do you have a development kit or prototyping kit? .....  | 47 |
| 6.1.3    | Want to see the project in action? .....                 | 47 |
| 6.2      | About the design .....                                   | 47 |
| 6.3      | Part 1: Create the design .....                          | 48 |
| 6.4      | Part 2: Program the device .....                         | 61 |
| <b>7</b> | <b>Summary</b> .....                                     | 64 |
|          | <b>References</b> .....                                  | 65 |
|          | <b>Revision history</b> .....                            | 66 |
|          | <b>Trademarks</b> .....                                  | 68 |
|          | <b>Disclaimer</b> .....                                  | 69 |

---

## 1 Introduction

### 1 Introduction

PSoC™ 4 is a true programmable embedded system-on-chip integrating custom analog and digital peripheral functions, memory, and an Arm® Cortex®-M0 or Cortex®-M0+ microcontroller on a single chip. This type of system is different from most mixed-signal embedded systems, which use a combination of a microcontroller unit (MCU) and external analog and digital peripherals. These systems typically require many integrated circuits in addition to the MCU, such as opamps, ADCs, and Application-specific Integrated Circuit (ASICs).

PSoC™ 4 provides a low-cost alternative to the combination of MCU and external ICs. In addition to reducing overall system cost, the programmable analog and digital subsystems allow great flexibility, in-field tuning of the design, and speedy time to market.

The capacitive touch-sensing feature in PSoC™ 4, known as CAPSENSE™, offers unprecedented signal-to-noise ratio; best-in-class liquid tolerance and a wide variety of sensor types such as buttons, sliders, trackpads, and proximity sensors. PSoC™ 4 offers a best-in-class current consumption of 150 nA while retaining SRAM, programmable logic, and the ability to wake up from an interrupt. PSoC™ 4 consumes only 20 nA while maintaining wakeup capability in its non-retention power mode. The PSoC™ 4 family of devices also contain PSoC™ 4 Bluetooth® LE, which integrates a Bluetooth® Low Energy radio system. For more details on PSoC™ 4 Bluetooth® LE, see [AN91267](#).

#### Using this document

The next few pages describe PSoC™ 4 and the advantages of designing with PSoC™, ModusToolbox™, and PSoC™ Creator. Or, you can jump right in and quickly build a simple design in ModusToolbox™ – go to [Getting started with PSoC™ 4 design](#). If you are using PSoC™ Creator – go to [My first PSoC™ 4 design using PSoC™ Creator](#).

## 2 Development ecosystem

## 2 Development ecosystem

### 2.1 PSoC™ resources

The wealth of information available on the [Infineon](#) webpage can help you select the right PSoC™ device and, additionally, integrate the device into your designs efficiently and effectively. The following is an abbreviated list for PSoC™ 4:

- Overview: [PSoC™ portfolio](#)
- Product selectors: [PSoC™ 4](#). In addition, [PSoC™ Creator](#) includes a device selection tool.
- [Datasheets](#) describe and provide electrical specifications for each family.
- [Application notes](#) cover a broad range of topics, from basic to advanced level, and include the following:
  - [AN88619](#): PSoC™ 4 hardware design considerations
  - [AN73854](#): Introduction to bootloaders
  - [AN89610](#): Arm® Cortex® code optimization
  - [AN86233](#): PSoC™ 4 low-power modes and power reduction techniques
  - [AN57821](#): Mixed-signal circuit board layout
  - [AN89056](#): PSoC™ 4 - IEC 60730 class B and IEC 61508 SIL Safety Software Library
  - [AN64846](#): Getting started with CAPSENSE™
  - [AN85951](#): PSoC™ 4 and PSoC™ 6 MCU CAPSENSE™ design guide
- [Code examples](#) demonstrate product features and usage
- [Technical reference manuals \(TRMs\)](#): Provide detailed descriptions of the architecture and registers in each PSoC™ 4 device family.
- [PSoC™ 4 programming specification](#) provides the information necessary to program PSoC™ 4 nonvolatile memory.
- [Development tools](#):
  - [CY8CKIT-040](#), [CY8CKIT-042](#), [CY8CKIT-044](#), [CY8CKIT-046](#), [CY8CKIT-042-BLE](#), [CY8CKIT-045S](#), and [CY8CKIT-041S-MAX](#) PSoC™ 4 Pioneer kits are easy-to-use and inexpensive development platforms. These include connectors for Arduino-compatible shields and Digilent Pmod daughter cards.
  - [CY8CKIT-043](#), [CY8CKIT-145-40XX](#), [CY8CKIT-147](#), [CY8CKIT-149](#), and [CY8CPROTO-040T](#) are very low-cost prototyping platforms for sampling PSoC™ 4 devices.
  - [CY8CKIT-040T](#) is a low-cost evaluation kit showing the low power CAPSENSE™, low power wake on touch and liquid tolerant features of the PSoC™ 4000T device.
  - The [MiniProg3](#) or [MiniProg4](#) kit provides an interface for flash programming and debug.
  - Integrated Development Environment (IDE): There are two development platforms that can be used for application development with PSoC™ 4 – [ModusToolbox™](#) and [PSoC™ Creator](#).
  - [PSoC™ 4 CAD libraries](#) provide footprint and schematic support for common tools. [IBIS models](#) are also available.
- Training videos are available in [Infineon](#) website on a wide range of topics including the [PSoC™ 4101 series](#)
- [Infineon community](#) enables connection with fellow PSoC™ developers around the world, 24 hours a day, 7 days a week, and hosts a dedicated [PSoC™ 4 MCU](#) community.

### 2.2 Firmware/application development

There are two development platforms that you can use for application development with PSoC™ 4:

- **ModusToolbox™**: This software includes configuration tools, low-level drivers, middleware libraries, and other packages that enable you to create MCU and wireless applications. All tools run on Windows, macOS, and Linux. ModusToolbox™ includes an Eclipse IDE, which provides an integrated flow with all the

## 2 Development ecosystem

ModusToolbox™ tools. Other IDEs such as Visual Studio Code, IAR Embedded Workbench and Arm® MDK (µVision) are also supported.

ModusToolbox™ software supports stand-alone device and middleware configurators. Use the configurators to set the configuration of different blocks in the device and generate code that can be used in firmware development. ModusToolbox™ supports all PSoC™ 6 MCU and the latest PSoC™ 4 MCU devices. [Table 1](#) lists the supported PSoC™ 4 devices. Infineon recommends you to use ModusToolbox™ for all application development for supported PSoC™ 4 devices. For more information, see [ModusToolbox™ tools package user guide](#).

**Table 1** List of PSoC™ 4 devices supported in ModusToolbox™

| Devices <sup>1)</sup>   | ModusToolbox™ | PSoC™ Creator |
|---|---------------|---------------|
| PSoC™ 4000S, PSoC™ 4100S, PSoC™ 4100S Plus, PSoC™ 4100S Plus 256K | Yes           | Yes           |
| PSoC™ 4100S Max, PSoC™ 4000T                                      | Yes           | No            |
| All other PSoC™ 4 devices   | No            | Yes           |

The libraries and enablement software are available on [GitHub](#).

ModusToolbox™ tools and resources can also be used in the command line. For more information, see the “ModusToolbox™ build system” section in the [ModusToolbox™ tools package user guide](#).

- **PSoC™ Creator:** [PSoC™ Creator](#) is a free Windows-based IDE. It enables concurrent hardware and firmware design of PSoC™ 3, PSoC™ 4, PSoC™ 5LP, and PSoC™ 6 MCU systems. Applications are created using schematic capture and over 150 pre-verified, production-ready peripheral Components.

### 2.2.1 Installing the ModusToolbox™ tools package

Refer to the [ModusToolbox™ tools package installation guide](#) for details.

### 2.2.2 Choosing an IDE

[Figure 1](#) helps you to choose an appropriate IDE.

<sup>1</sup> [PSoC™ 4 feature set](#) for complete PSoC™ 4 portfolio.

2 Development ecosystem

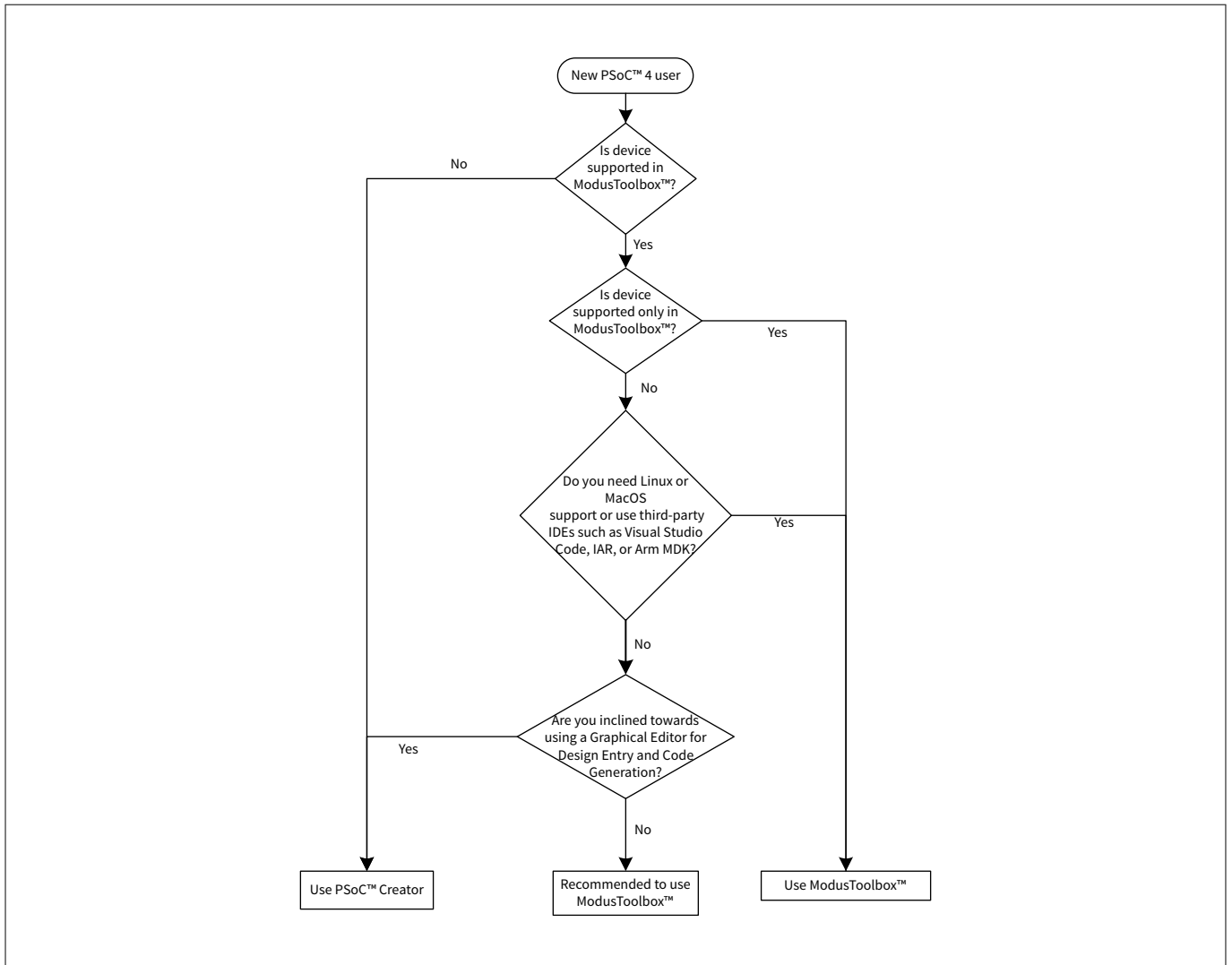
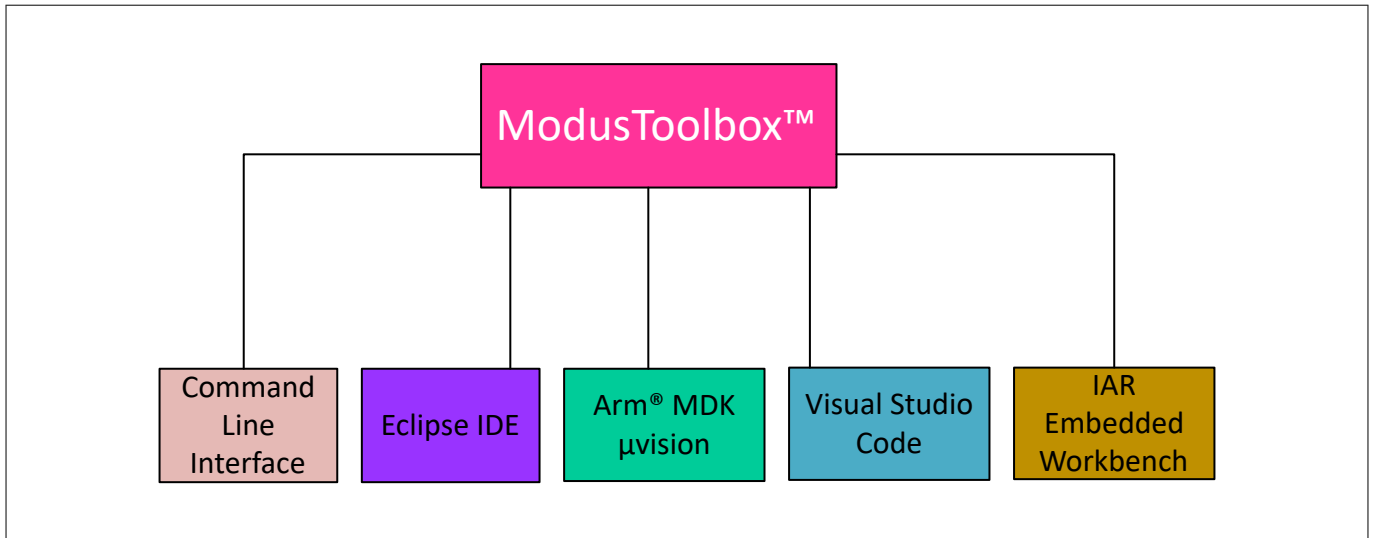

Figure 1 Choosing an IDE

ModusToolbox™ software, the latest-generation toolset, is supported across Windows, Linux, and macOS platforms. ModusToolbox™ software supports 3rd-party IDEs, including the Eclipse IDE, Visual Studio Code, Arm® MDK (µVision), and IAR Embedded Workbench. The tools package includes an implementation for the Eclipse IDE and Visual Studio Code (VS Code) for your convenience. The tools support all PSoC™ 4s. The associated BSP and library configurators also work on all three host operating systems.

## 2 Development ecosystem



**Figure 2 ModusToolbox™ environment**

Certain features of the PSoC™ 4, such as UDBs (Universal Digital Blocks) and USB are not supported in ModusToolbox™ version 2.x and earlier. Newer versions of ModusToolbox™ support the USB host feature and improve the user experience with true multi-core debug support.

It is recommended to use ModusToolbox™ if you want to build an IoT application using IoT devices, or if you are using a PSoC™ 4 not supported in PSoC™ Creator.

PSoC™ Creator is the long-standing proprietary tool that runs on Windows only. This mature IDE includes a graphical editor that supports schematic based design entry with the help of Components. PSoC™ Creator supports all PSoC™ 3, PSoC™ 4, and PSoC™ 5LP devices, and a subset of PSoC™ 4 devices.

Choose PSoC™ Creator if you are using a graphical editor for design entry and code generation, and if the PSoC™ MCU that you are planning to use is supported by the IDE.

### 2.2.3 ModusToolbox™ software

ModusToolbox™ software is a set of tools and software that enables an immersive development experience for creating converged MCU and wireless systems, and enables you to integrate our devices into your existing development methodology. These include configuration tools, low-level drivers, libraries, and operating system support, most of which are compatible with Linux-, macOS-, and Windows-hosted environments.

Figure 3 shows a high-level view of what is available as part of ModusToolbox™ software. For a more in-depth overview of the ModusToolbox™ software, see [ModusToolbox™ tools package user guide](#).

2 Development ecosystem

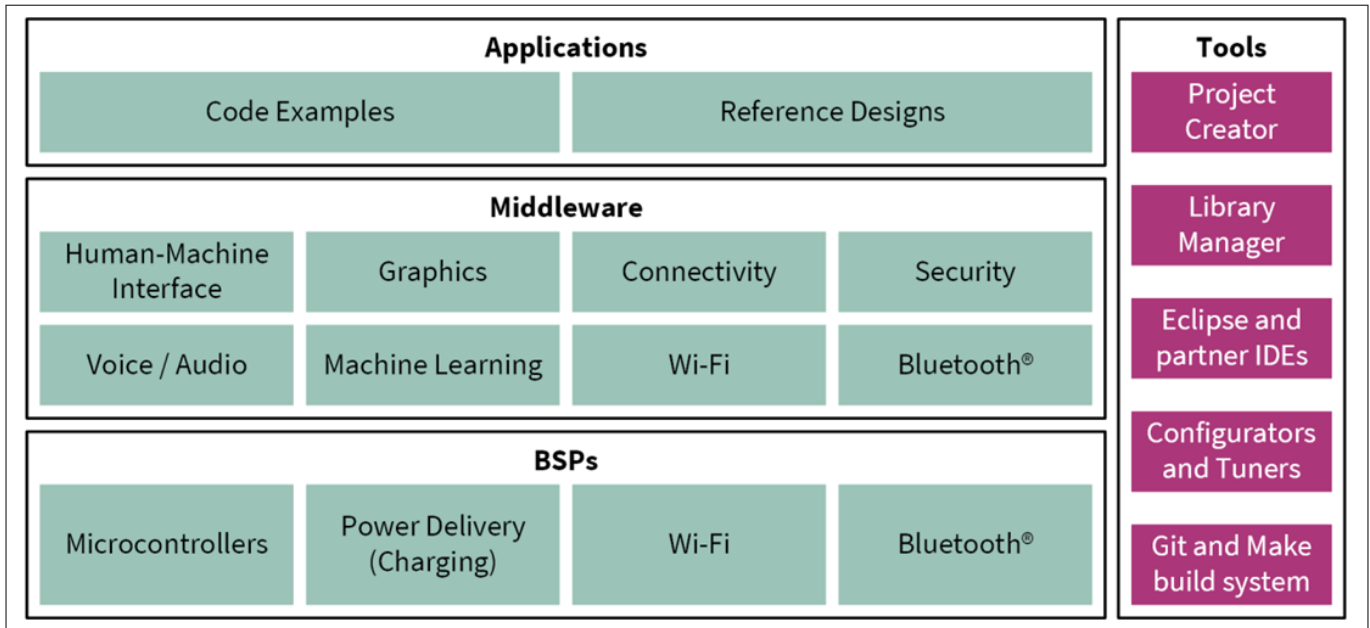

Figure 3 ModusToolbox™ software

The ModusToolbox™ tools package installer includes the design configurators and tools, and the build system infrastructure.

The build system infrastructure includes the new project creation wizard that can be run independent of the Eclipse IDE, the make infrastructure, and other tools. This means you choose your compiler, IDE, RTOS, and ecosystem without compromising usability or access to our industry-leading CAPSENSE™ (Human-Machine Interface), AIROC™ Wi-Fi and Bluetooth®, security, and various other features.

One part of the ModusToolbox™ ecosystem is run-time software that helps you rapidly develop Wi-Fi and Bluetooth® applications using connectivity combo devices. See the [ModusToolbox™ run-time software reference guide](#) for details.

Design configurators are the tools that help you create the configurable code for your BSP/Middleware. Jump to [Configurators](#) to know more about it.

All the application-level development flows depend on the provided low-level resources. These include:

- Board support packages (BSP) – A BSP is the layer of firmware containing board-specific drivers and other functions. The BSP is a set of libraries that provides APIs to initialize the board and access to board level peripherals. It includes low-level resources such as peripheral driver library (PDL) for PSoC™ 4 and has macros for board peripherals. Custom BSPs can be created to enable support for end-application boards. See [BSP Assistant](#) to create your BSP.
- PSoC™ 4 [peripheral driver library \(PDL\)](#) – The PDL integrates device header files, start-up code, and peripheral drivers into a single package. The PDL supports the PSoC™ 4 family. The drivers abstract the hardware functions into a set of easy-to-use APIs. These are fully documented in the PDL API Reference. The PDL reduces the need to understand register usage and bit structures, thus easing software development for the extensive set of peripherals in the PSoC™ 4 series. You configure the driver for your application, and then use API calls to initialize and use the peripheral.
- Middleware (MW) – Extensive middleware libraries that provide specific capabilities to an application. The [available middleware](#) spans across connectivity (OTA, Bluetooth®, AWS IoT, Bluetooth® LE, Secure Sockets) to PSoC™ 4-specific functionality (CAPSENSE™, USB, device firmware upgrade (DFU), emWin). All the middleware is delivered as libraries and via GitHub repositories.



## 2 Development ecosystem

### 2.2.4 ModusToolbox™ applications

With the release of ModusToolbox™ v3.x, multi-core support is introduced, which has altered the folder structure slightly from the previous version of ModusToolbox™, but PSoC™ 4 has single core only.

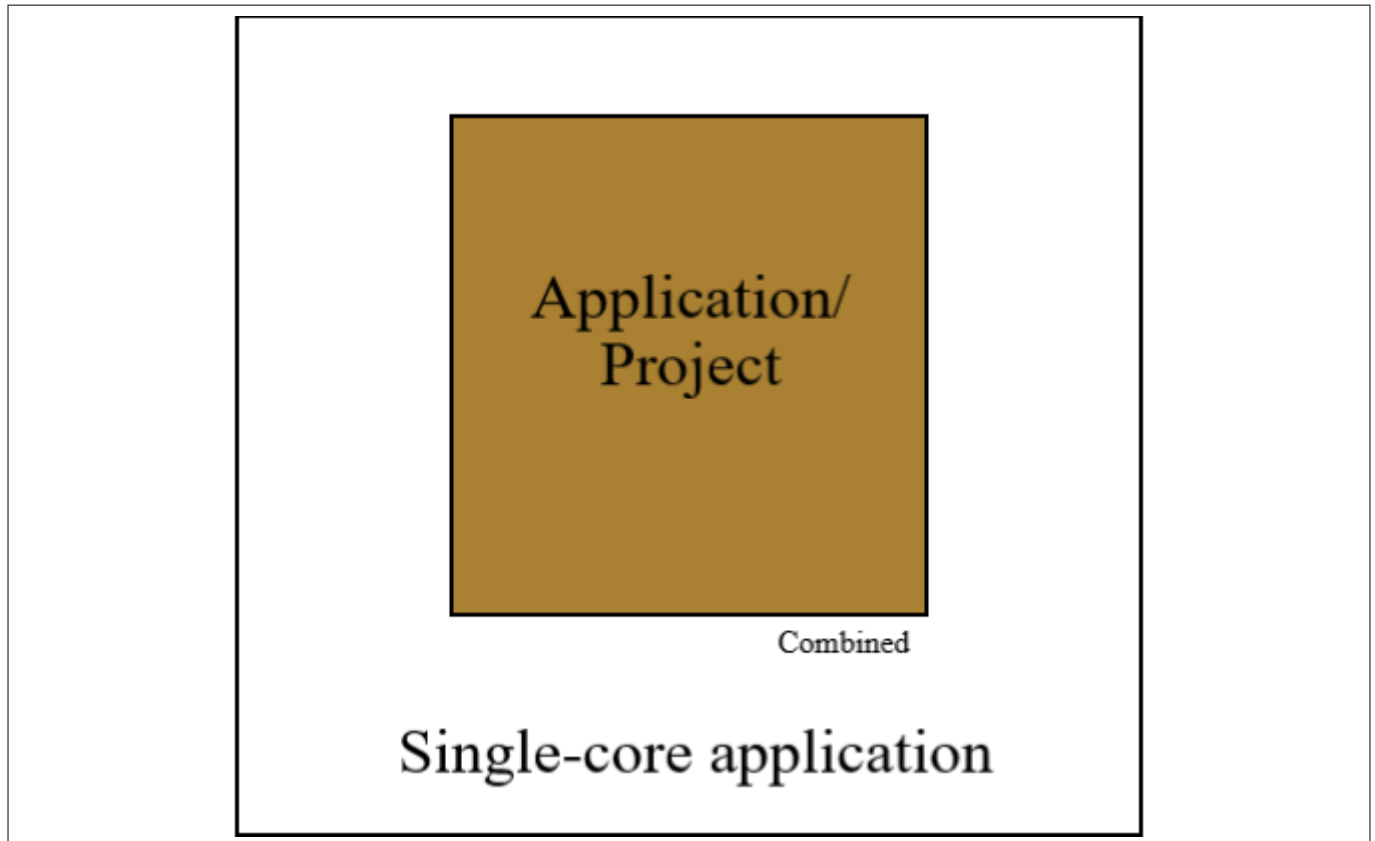

**Figure 4 Application type**

The following shows the new folder structure for an example single-core application:

## 2 Development ecosystem

```

<root>
  ApplicationName
  ->Makefile (MTB_TYPE=COMBINED)
  ->deps
    lib1.mtb (local)
    lib2.mtb (shared)
  ->libs
    lib1 (Infineon Git repo)
  ->bsps
    TARGET_BSP1 (not an Infineon Git repo; completely app-owned)
  ->templates
    TARGET_BSP1
      design.modus
      design.capsense
  ->main.c
  ->helper.h
  ->helper.c
  mtb_shared
    lib2/... (Infineon Git repo)

```

**Figure 5** Folder structure for single-core applications

### 2.2.5 PSoC™ 4 software resources

The software for PSoC™ 4s includes configurators, drivers, libraries, middleware, as well as various utilities, makefiles, and scripts. It also includes relevant drivers, middleware, and examples for use with IoT devices and connectivity solutions. You may use any or all tools in any environment you prefer.

#### 2.2.5.1 Configurators

ModusToolbox™ software provides graphical applications called configurators that make it easier to configure a hardware block. For example, instead of having to search through all the documentation to configure a serial communication block as a UART with a desired configuration, open the appropriate configurator and set the baud rate, parity, and stop bits. Upon saving the hardware configuration, the tool generates the "C" code to initialize the hardware with the desired configuration.

There are two types of configurators: BSP configurators that configure items that are specific to the MCU hardware and library configurators that configure options for middleware libraries.

Configurators are independent of each other, but they can be used together to provide flexible configuration options. They can be used stand alone, in conjunction with other tools, or within a complete IDE. Configurators are used for:

- Setting options and generating code to configure drivers
- Setting up connections such as pins and clocks for a peripheral
- Setting options and generating code to configure middleware

For PSoC™ 4 applications, the available Configurators include:

- Device Configurator: Sets up the system (platform) functions and the basic peripherals (for example, UART, Timer, PWM).

## 2 Development ecosystem

- CAPSENSE™ Configurator and Tuner: Configures CAPSENSE™ and generates the required code.
- Smart I/O Configurator: Configures the Smart I/O.

Each of the above configurators create their own files (For example, `design.cycapsense` for CAPSENSE™). BSP configurator files (For example, `design.modus` or `design.cycapsense`) are provided as part of the BSP with default configurations while library configurators (e.g. `design.cybt`) are provided by the application. When an application is created based on Infineon BSP, the application makes use of BSP configurator files from the Infineon BSP repo. You can customize/create all the configurator files as per your application requirement using ModusToolbox™ software. See [BSP Assistant](#) to create your custom BSP. See [ModusToolbox™ help](#) for more details.

### 2.2.5.2 Library management for PSoC™ 4

The application can have shared/local libraries for the projects. If needed, different projects can use different versions of the same library. The shared libraries are downloaded under the `mtb_shared` directory. The application should use the `deps` folder to add library dependencies. The `deps` folder contains files with the `.mtb` file extension, which is used by ModusToolbox™ to download its git repository. These libraries are direct dependencies of the ModusToolbox™ project.

The Library Manager helps to add/remove/update the libraries of your projects. It also identifies whether particular library has a direct dependency on any other library using the manifest repository available on GitHub, and fetches all its dependencies. These dependency libraries are indirect dependencies of the ModusToolbox™ project. These dependencies can be seen under the `libs` folder. For more information, see the [Library Manager user guide](#) located at `<install_dir> /ModusToolbox/tools_<version>/library-manager/docs/library-manager.pdf`.

### 2.2.5.3 Software development for PSoC™ 4

The ModusToolbox™ ecosystem provides significant source code and tools to enable software development for PSoC™ 4s. You use tools to:

- Specify how you want to configure the hardware.
- Generate code for that purpose, which you use in your firmware.
- Include various middleware libraries for additional functionality, like Bluetooth® LE connectivity or FreeRTOS.

This source code makes it easier to develop the firmware for supported devices. It helps you quickly customize and build firmware without the need to understand the register set.

In the ModusToolbox™ environment, you use configurators to configure either the device, or a middleware library, like the Bluetooth® LE stack or CAPSENSE™. The BSP configurator files are used to configure device peripherals, pins, and memory using peripheral driver library code. The middleware is delivered as separate libraries for each feature/function such that it can be used across multiple platforms. For example, `abstractionrtos`, `lwip`, `usb`, etc.

Firmware developers who wish to work at the register level should refer to the driver source code from the PDL. The PDL includes all the device-specific header files and startup code you need for your project. It also serves as a reference for each driver. Because the PDL is provided as source code, you can see how it accesses the hardware at the register level.

Some devices do not support particular peripherals. The PDL is a superset of all the drivers for any supported device. This superset design means:

- All API elements needed to initialize, configure, and use a peripheral are available.
- The PDL is useful across various PSoC™ 4s, regardless of available peripherals.
- The PDL includes error checking to ensure that the targeted peripheral is present on the selected device.

## 2 Development ecosystem

This enables the code to maintain compatibility across members of the PSoC™ 4 family, as long as the peripherals are available. A device header file specifies the peripherals that are available for a device. If you write code that attempts to use an unsupported peripheral, you will get an error at compile time. Before writing code to use a peripheral, consult the datasheet for the particular device to confirm support for that peripheral.

As the following figure shows, with the ModusToolbox™ software, you can:

1. Choose a MCU or BSP (Project Creator).
2. Create a new application based on a list of starter applications, filtered by the BSPs that each application supports (Project Creator).
3. Add BSP or middleware libraries (Library Manager).
4. Develop your application firmware using PDL for PSoC™ 4 (IDE of choice or command line).

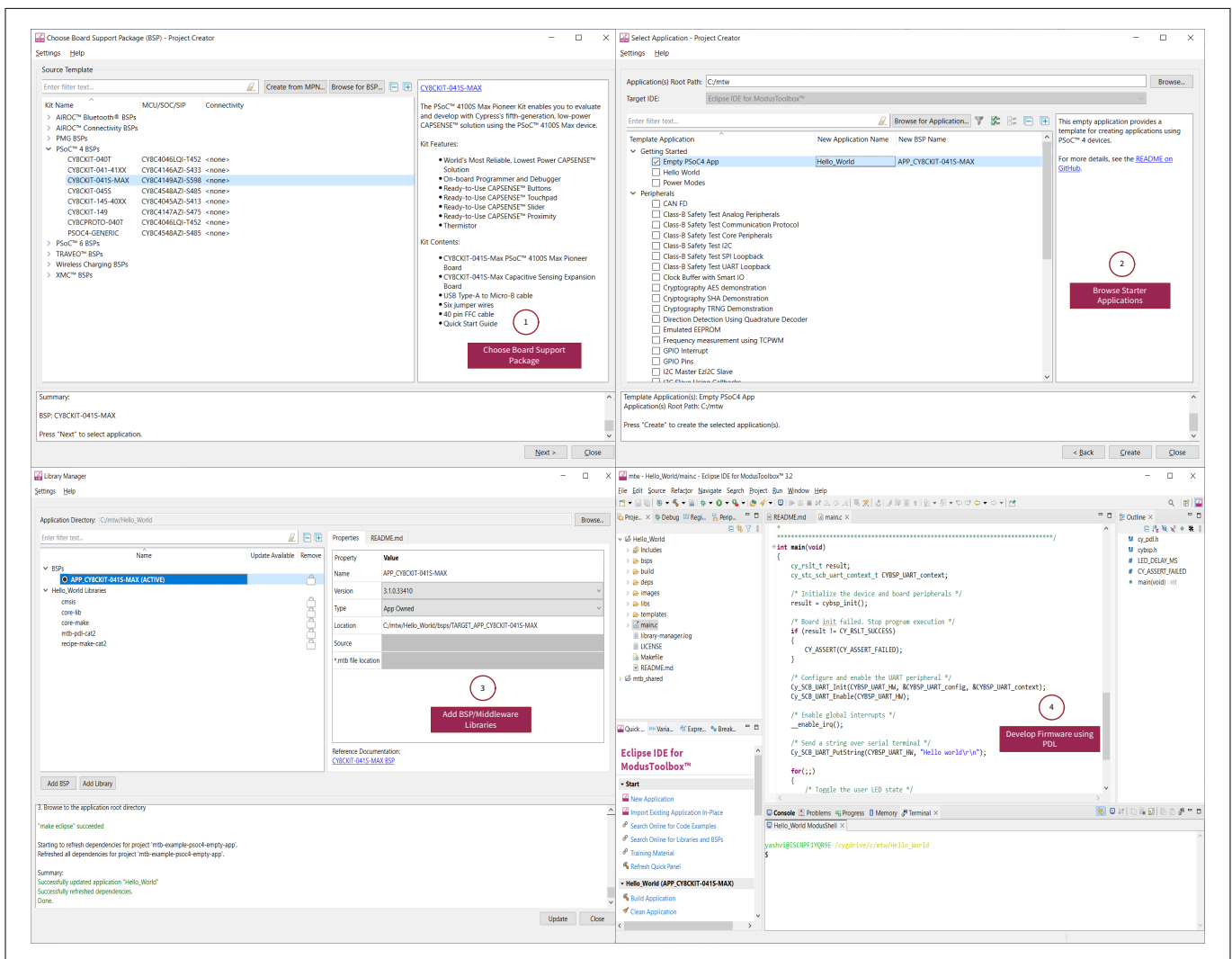

Figure 6 ModusToolbox™ resources and middleware

### 2.2.6 ModusToolbox™ help

The ModusToolbox™ ecosystem provides documentation and training. One way to access it is launching the Eclipse IDE for ModusToolbox™ software and navigating to the following **Help** menu items:

Choose **Help > ModusToolbox™ General Documentation:**

- **ModusToolbox™ Documentation Index:** Provides brief descriptions and links to various types of documentation included as part the ModusToolbox™ software.
- **ModusToolbox™ Installation Guide:** Provides instructions for installing the ModusToolbox™ software.

## 2 Development ecosystem

- **ModusToolbox™ User Guide:** This guide primarily covers the ModusToolbox™ aspects of building, programming and debugging applications. It also covers various aspects of the tools installed along with the IDE.
- **ModusToolbox™ Training Material:** Links to the training material available at <https://github.com/Infineon/training-modustoolbox>.
- **Release Notes**

For documentation on Eclipse IDE for ModusToolbox™, choose **Help > Eclipse IDE for ModusToolbox™ Documentation:**

- **User Guide:** Provides descriptions about creating applications as well as building, programming, and debugging them using Eclipse IDE
- **Eclipse IDE Survival Guide**

### 2.3 Support for other IDEs

You can develop firmware for PSoC™ 4s using your preferred IDE such as Eclipse IDE, [IAR Embedded Workbench](#), [Keil µVision 5](#) or [Visual Studio Code](#).

ModusToolbox™ Configurators are stand-alone tools that can be used to set up and configure PSoC™ 4 resources and other middleware components without using the Eclipse IDE. The Device Configurator and middleware configurators use the `design.x` files within the application workspace. You can then point to the generated source code and continue developing firmware in your IDE.

If there is a change in the device configuration, edit the `design.x` files using the configurators and regenerate the code. It is recommended that you generate resource configurations using the configuration tools provided with ModusToolbox™ software.

See [ModusToolbox™ tools package user guide](#) for details.

### 2.4 PSoC™ Creator

[PSoC™ Creator](#) is an IDE that enables concurrent hardware and firmware editing, compiling, and debugging of PSoC™ systems. Do the following to browse through PSoC™ Creator, as shown in [Figure 7](#):

1. Drag and drop Components to build your hardware system design
2. Co-design your application firmware with the PSoC™ hardware
3. Configure Components with config tools
4. Explore the library of more than 100 Components
5. Review Component datasheets

## 2 Development ecosystem

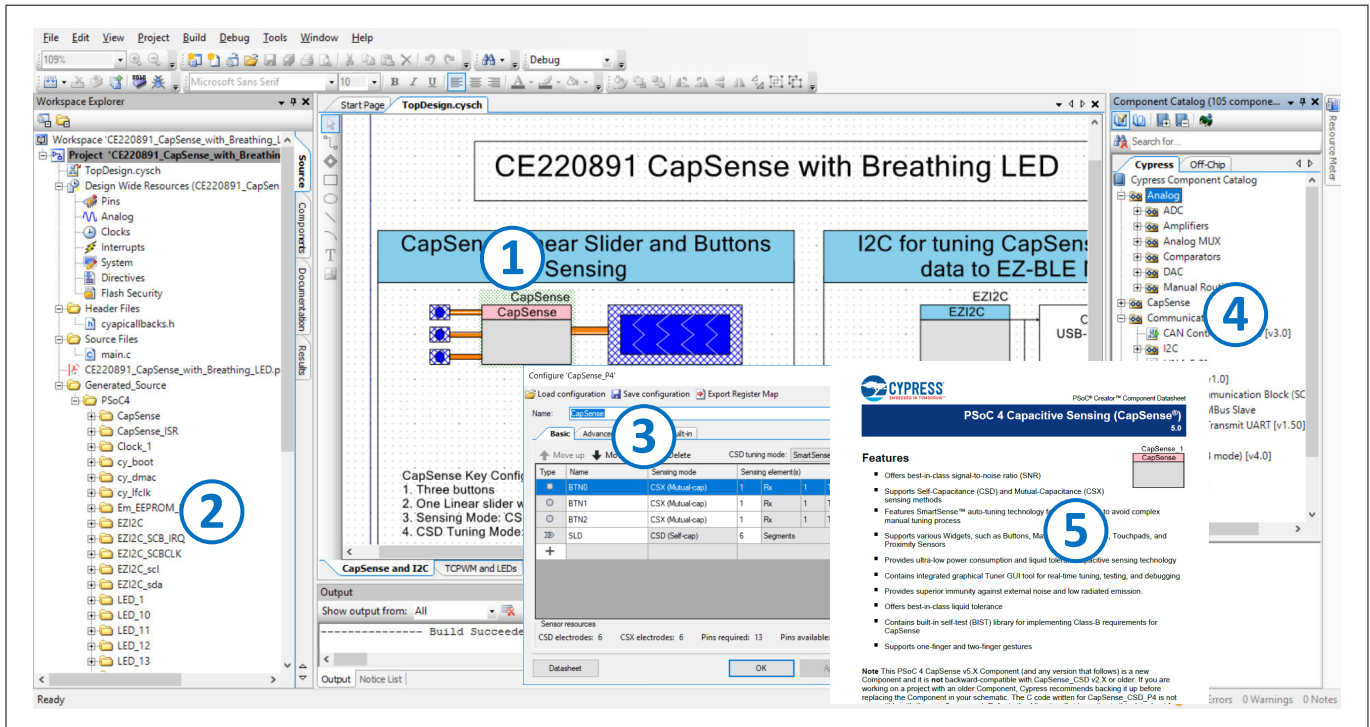

**Figure 7** Features of PSoC™ Creator features

### 2.4.1 PSoC™ Creator help

Download the PSoC™ Creator's latest version from the [PSoC™ Creator](#) home page, launch the PSoC™ Creator, and navigate to the following:

- Quick Start Guide: Choose Help > Documentation > Quick Start Guide. This guide gives you the basics for developing PSoC™ Creator projects.
- Simple Component example projects: Choose File > Open > Example projects. These example projects demonstrate how to configure and use PSoC™ Creator Components.
- System Reference Guide: Choose Help > System Reference > System Reference Guide. This guide lists and describes the system functions provided by PSoC™ Creator.
- Component datasheets: Right-click a Component and select Open Datasheet. Visit the [PSoC™ 4 Component datasheets](#) page for a list of all PSoC™ 4 Component datasheets.
- [PSoC™ Creator training videos](#): These videos provide step-by-step instructions on how to get started with PSoC™ Creator.
- Document Manager: PSoC™ Creator provides a document manager to help you to find and review document resources easily. To open the document manager, choose the menu item Help > Document Manager.

### 2.5 Technical support

If you have any questions, our technical support team is happy to assist you. You can create a support request on the [Technical support](#) page. The support team monitors and responds to your questions, issues, and bug reports posted on the [GitHub](#) repositories.

3 PSoC™ 4 feature set

3 PSoC™ 4 feature set

PSoC™ 4 has an extensive set of features, which include a CPU and memory subsystem, a digital subsystem, an analog subsystem, and system resources, as shown in Figure 8. The following sections describe each feature. For more information, see the PSoC™ 4 family device datasheets, technical reference manuals (TRMs), and application notes listed in PSoC™ resources.

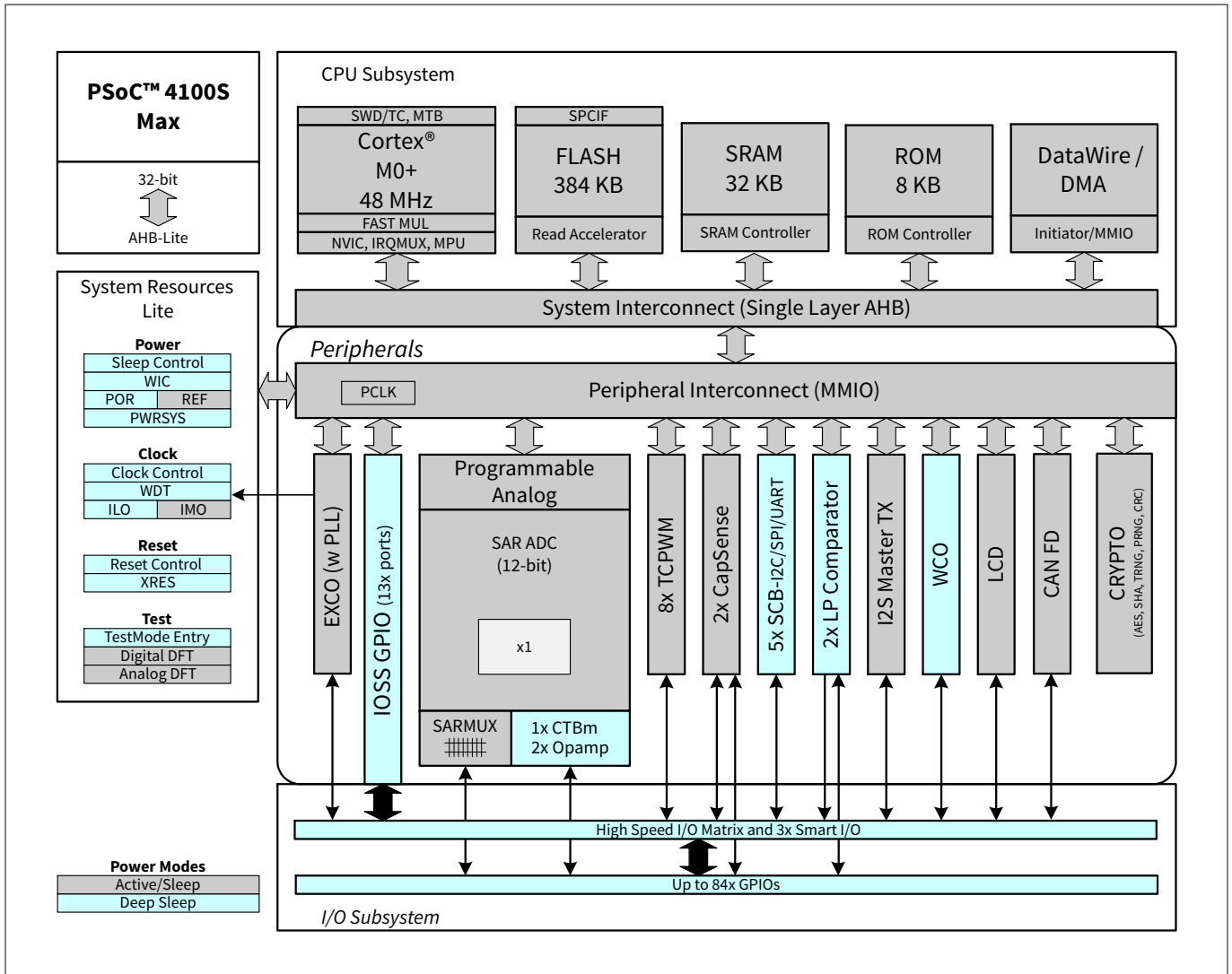

Figure 8 PSoC™ 4000 architecture (PSoC™ 4100S Max)

The PSoC™ 4 portfolio consists of several families of Arm® CM0 and CM0+ microcontrollers. Most devices in the portfolio have CAPSENSE™ technology for capacitive-sensing applications. Other key features of the PSoC™ 4 portfolio include a customizable analog front end through programmable analog blocks and wired and wireless connectivity options such as USB, Controller Area Network (CAN), and Bluetooth® LE. These unique features make PSoC™ 4 the industry’s most flexible and scalable low-power mixed-signal architecture. The PSoC™ 4 devices are classified as different families, as shown in Table 2, based on different features.

Table 2 PSoC™ 4 families

| Classification | Family            | Features  | Details |
|----------------|-------------------|-----------|---------|
| Entry level    | PSoC™ 4000 family | CAPSENSE™ | Table 3 |

(table continues...)

## 3 PSoC™ 4 feature set

**Table 2** (continued) PSoC™ 4 families

| Classification                   | Family            | Features  | Details                  |
|----------------------------------|-------------------|---|--------------------------|
| Intelligent analog               | PSoC™ 4100 family | CAPSENSE™ + Programmable Analog                               | <a href="#">Table 4</a>  |
| Programmable digital             | PSoC™ 4200 family | CAPSENSE™ + Programmable Analog + Programmable Digital Blocks | <a href="#">Table 5</a>  |
| Application specific             | PSoC™ 4500 family | CAPSENSE™ + Motor Control                                     | <a href="#">Table 6</a>  |
|                                  | PSoC™ 4700 family | CAPSENSE™ + Inductive Sensing                                 |                          |
| Analog coprocessor <sup>2)</sup> | PSoC™ 4A00 family | CAPSENSE™ + Programmable Analog Blocks                        | <a href="#">AN211293</a> |

**Note:** In [Table 3](#) and [Table 4](#), the columns highlighted in green indicate that the device family is supported in ModusToolbox™.

**Table 3** PSoC™ 4000 family features

| Features                          | PSoC™ 4000                                      | PSoC™ 4000S                                   | PSoC™ 4000T         |                            |
|-----------------------------------|---|---|---------------------|----------------------------|
| CPU                               | 16-MHz Cortex® -M0                              | 48-MHz Cortex® -M0+                           | 48-MHz Cortex® -M0+ |                            |
| Flash memory                      | 16 KB   | 32 KB   | 64 KB               |                            |
| SRAM                              | 2 KB  | 4 KB  | 8 KB                |                            |
| GPIOs                             | 20  | 36  | 21                  |                            |
| CAPSENSE™                         | Sense pins                                      | 16  | 35                  | 19                         |
|                                   | Ultra-Low Power Wake on Touch (WoT)             | No  | No                  | Yes                        |
|                                   | CAPSENSE™ IP Generation                         | Fourth-generation                             | Fifth-generation    | Fifth-generation Low Power |
| Single-slope ADC (10-bit 46-ksps) | None  | 1   | None                |                            |
| Comparators                       | 1 CSD comparator with a fixed threshold (1.2 V) | Two low-power comparators with wakeup feature | None                |                            |
| IDACs <sup>3)</sup>               | One 7-bit and one 8-bit                         | Two 7-bits                                    | None                |                            |
| Smart I/O ports                   | None  | 2   | None                |                            |

**(table continues...)**

<sup>2</sup> See [AN211293](#) for getting started with PSoC™ 4 analog coprocessor family devices.

<sup>3</sup> IDACs are available only when CAPSENSE™ is not in use. See the respective PSoC™ 4 architecture TRM for more details.



3 PSoC™ 4 feature set

**Table 3** (continued) PSoC™ 4000 family features

| Features                                    |                                     | PSoC™ 4000                                     | PSoC™ 4000S                                  | PSoC™ 4000T  |
|---|-------------------------------------|--|--|--|
| Power supply range                          |                                     | 1.71 V to 5.5 V                                | 1.71 V to 5.5 V                              | 1.71 V to 5.5 V  |
| Low-power modes                             |                                     | Deep Sleep at 2.5 µA                           | Deep Sleep at 2.5 µA                         | Deep Sleep at 2.5 µA   |
| Segment LCD drive                           |                                     | None   | 4 COM segment LCD drive                      | None   |
| Serial communication                        |                                     | One I2C  | Two SCBs with programmable I2C, SPI, or UART | 1 SCB with programmable I2C, SPI, or UART. 1 SCB having I <sup>2</sup> C only                              |
| Timer Counter Pulse-Width Modulator (TCPWM) |                                     | 1  | 5  | 2  |
| Clocks                                      | Internal main oscillator (IMO)      | 24 MHz/32 MHz                                  | 24 MHz to 48 MHz                             | 24 MHz to 48 MHz   |
|   | Internal low-speed oscillator (ILO) | 32-kHz internal ILO                            | 40 kHz                                       | 40 kHz   |
|   | Watch crystal oscillator (WCO)      | None   | 32-kHz                                       | None   |
| Power supply monitoring                     |                                     | Power-on reset (POR) Brown-out detection (BOD) | POR, BOD                                     | POR, BOD   |
| Supported kit                               |                                     | CY8CKIT-040 pioneer kit                        | -  | CY8CKIT-040T PSoC™ 4000T CAPSENSE™ Evaluation Kit and CY8CPROTO-040T PSoC™ 4000T CAPSENSE™ Prototyping Kit |
| Supported IDE                               |                                     | PSoC™ Creator                                  | PSoC™ Creator, ModusToolbox™                 | ModusToolbox™  |

**Table 4** PSoC™ 4100 family features

| Features | PSoC™ 4100         | PSoC™ 4100S         | PSoC™ 4100S Plus    | PSoC™ 4100S Plus 256K | PSoC™ 4100PS        | PSoC™ 4100M        | PSoC™ 4100 BL <sup>4)</sup> | PSoC™ 4100S Max     |
|----------|--------------------|---------------------|---------------------|-----------------------|---------------------|--------------------|-----------------------------|---------------------|
| CPU      | 24-MHz Cortex® -M0 | 48-MHz Cortex® -M0+ | 48-MHz Cortex® -M0+ | 48-MHz Cortex® -M0+   | 48-MHz Cortex® -M0+ | 24-MHz Cortex® -M0 | 24-MHz Cortex® -M0          | 48-MHz Cortex® -M0+ |
| DMA      | N/A                | N/A                 | 8 channels          | 8 channels            | 8 channels          | 8 channels         | 8 channels                  | 16 channels         |

(table continues...)

<sup>4</sup> See AN91267 for getting started with PSoC™ 4 Bluetooth® LE Family devices.

## 3 PSoC™ 4 feature set

Table 4 (continued) PSoC™ 4100 family features

| Features                                    | PSoC™<br>4100            | PSoC™<br>4100S           | PSoC™<br>4100S<br>Plus   | PSoC™<br>4100S<br>Plus 256K | PSoC™<br>4100PS          | PSoC™<br>4100M            | PSoC™<br>4100 BL <sup>4)</sup> | PSoC™<br>4100S<br>Max                         |
|---|--------------------------|--------------------------|--------------------------|-----------------------------|--------------------------|---------------------------|--------------------------------|---|
| Flash memory                                | 32 KB                    | 64 KB                    | 128 KB                   | 256 KB                      | 32 KB                    | 128 KB                    | 256 KB                         | 384 KB  |
| SRAM  | 4 KB                     | 8 KB                     | 16 KB                    | 32 KB                       | 4 KB                     | 16 KB                     | 32 kB                          | 32 KB   |
| GPIOs                                       | 36                       | 36                       | 54                       | 54                          | 38                       | 55                        | 36                             | 84  |
| CAPSENSE™                                   | 1 channel,<br>35 sensors | 1 channel,<br>35 sensors | 1 channel,<br>53 sensors | 1 channel,<br>53 sensors    | 1 channel,<br>33 sensors | 2 channels,<br>54 sensors | 1 channel,<br>35 sensors       | 2 channels,<br>80 sensors<br>(32 control mux) |
| 12-bit SAR ADC with sequencer               | 806-KSPS                 | 1-MSPS                   | 1-MSPS                   | 1-MSPS                      | 1-MSPS                   | 806-KSPS                  | 806-KSPS                       | 1-MSPS  |
| Opamps (programmable)                       | 2                        | 2                        | 2                        | 2                           | 4/PGA                    | 4                         | 2                              | 2   |
| Programmable Voltage Reference (PVref)      | None                     | None                     | None                     | None                        | Four channels            | None                      | None                           | None  |
| Voltage DAC (VDAC)                          | None                     | None                     | None                     | None                        | Two 13-bit VDAC          | None                      | None                           | None  |
| Comparators (low power with wakeup feature) | 2                        | 2                        | 2                        | 2                           | 2                        | 2                         | 2                              | 2   |
| IDACs <sup>5)</sup>                         | One 7-bit and one 8-bit  | Two 7-bits               | Two 7-bits               | Two 7-bits                  | Two 7-bits               | Two 7-bits and two 8-bits | One 7-bit and one 8-bit        | None  |
| Smart I/O ports                             | None                     | 2                        | 3                        | 2                           | 1                        | None                      | None                           | 3   |
| Power supply range                          | 1.71 V to 5.5 V          | 1.71 V to 5.5 V          | 1.71 V to 5.5 V          | 1.71 V to 5.5 V             | 1.71 V to 5.5 V          | 1.71 V to 5.5 V           | 1.71 V to 5.5 V                | 1.71 V to 5.5 V                               |
| Low-power Deep sleep                        | 1.3 µA                   | 2.5 µA                   | 2.5 µA                   | 2.5 µA                      | 2.5 µA                   | 1.35 µA                   | 2.5 µA                         | 2.5 µA  |

(table continues...)

<sup>4</sup> See [AN91267](#) for getting started with PSoC™ 4 Bluetooth® LE Family devices.

<sup>5</sup> IDACs are available only when CAPSENSE™ is not in use. See the respective PSoC™ 4 architecture TRM more details.

## 3 PSoC™ 4 feature set

**Table 4** (continued) PSoC™ 4100 family features

| Features                                 |           | PSoC™ 4100                            | PSoC™ 4100S                  | PSoC™ 4100S Plus             | PSoC™ 4100S Plus 256K        | PSoC™ 4100PS                 | PSoC™ 4100M              | PSoC™ 4100 BL <sup>4)</sup>  | PSoC™ 4100S Max               |
|--|-----------|---------------------------------------|------------------------------|------------------------------|------------------------------|------------------------------|--------------------------|------------------------------|-------------------------------|
| modes                                    | Hibernate | 150 nA                                | NA                           | NA                           | NA                           | NA                           | 150 nA                   | NA                           | NA                            |
|  | Stop      | 20 nA                                 | NA                           | NA                           | NA                           | NA                           | 35 nA                    | NA                           | NA                            |
| Segment LCD drive                        |           | 4 COM                                 | 4 COM                        | 4 COM                        | 4 COM                        | 4 COM                        | 4 COM                    | 4 COM                        | 4 COM                         |
| SCBs with programmable I2C, SPI, or UART |           | 2                                     | 3                            | 5                            | 5                            | 3                            | 4                        | 2                            | 5                             |
| TCPWM                                    |           | 4                                     | 5                            | 8                            | 8                            | 8                            | 8                        | 4                            | 8                             |
| CAN                                      |           | None                                  | None                         | 1                            | None                         | None                         | None                     | None                         | 1                             |
| BLE                                      |           | None                                  | None                         | None                         | None                         | None                         | None                     | 4.1/4.2                      | None                          |
| Clocks                                   | IMO       | 3 MHz to 24 MHz                       | 24 MHz to 48 MHz             | 24 MHz to 48 MHz             | 24 MHz to 48 MHz             | 24 MHz to 48 MHz             | 3 MHz to 48 MHz          | 24 MHz to 48 MHz             | 24 MHz to 48 MHz              |
|  | ILO       | 32 kHz                                | 40 kHz                       | 40 kHz                       | 40 kHz                       | 40 kHz                       | 32 kHz                   | 40 kHz                       | 40 kHz                        |
|  | WCO       | Nil                                   | 32 kHz                       | 32 kHz                       | 32 kHz                       | 32 kHz                       | 32 kHz                   | 32 kHz                       | 32 kHz                        |
| Power supply monitoring                  |           | POR, BOD, Low-voltage detection (LVD) | POR, BOD                     | POR, BOD                     | POR, BOD                     | POR, BOD                     | POR, BOD, LVD            | POR, BOD, LVD                | POR, BOD                      |
| Supported kit                            |           | -                                     | -                            | CY8CKIT-1 49 prototyping kit | -                            | CY8CKIT-1 47 prototyping kit | CY8CKIT-0 44 pioneer kit | CY8CKIT-0 42 BLE pioneer kit | CY8CKIT-0 41S-MAX pioneer kit |
| Supported IDE                            |           | PSoC™ Creator                         | PSoC™ Creator, ModusToolbox™ | PSoC™ Creator, ModusToolbox™ | PSoC™ Creator, ModusToolbox™ | PSoC™ Creator                | PSoC™ Creator            | PSoC™ Creator                | ModusToolbox™                 |

**Table 5** PSoC™ 4200 family features

| Features | PSoC™ 4200          | PSoC™ 4200DS        | PSoC™ 4200M         | PSoC™ 4200L         | PSoC™ 4200 BL <sup>6)</sup> |
|----------|---------------------|---------------------|---------------------|---------------------|-----------------------------|
| CM0 CPU  | 48 MHz Cortex® - M0 | 48 MHz Cortex® - M0 | 48 MHz Cortex® - M0 | 48 MHz Cortex® - M0 | 48 MHz Cortex® - M0         |

(table continues...)

<sup>4</sup> See [AN91267](#) for getting started with PSoC™ 4 Bluetooth® LE Family devices.

<sup>6</sup> See [AN91267](#) for getting started with PSoC™ 4 Bluetooth® LE family devices.

## 3 PSoC™ 4 feature set

Table 5 (continued) PSoC™ 4200 family features

| Features                                    | PSoC™ 4200               | PSoC™ 4200DS    | PSoC™ 4200M               | PSoC™ 4200L               | PSoC™ 4200 BL <sup>6)</sup> |        |
|---|--------------------------|-----------------|---------------------------|---------------------------|-----------------------------|--------|
| DMA   | None                     | 8 channels      | 8 channels                | 32 channels               | None                        |        |
| Flash memory                                | 32 KB                    | 64 KB           | 128 KB                    | 256 KB                    | 256 KB                      |        |
| SRAM  | 4 KB                     | 8 KB            | 16 KB                     | 32 KB                     | 32 KB                       |        |
| GPIOs                                       | 36                       | 21              | 55                        | 96                        | 36                          |        |
| CAPSENSE™                                   | 1 channel, 35 sensors    | None            | 2 channels, 54 sensors    | 2 channels, 94 sensors    | 1 channel, 35 sensors       |        |
| ADC (12-bit, 1-MSPS SAR ADC with sequencer) | 1                        | None            | 1                         | 1                         | 1                           |        |
| Opamps (programmable)                       | 2                        | None            | 2                         | 4                         | 2                           |        |
| Comparators (low power with wakeup feature) | 2                        | 2               | 2                         | 2                         | 2                           |        |
| IDACs <sup>7)</sup>                         | One 7-bits and one 8-bit | None            | Two 7-bits and two 8-bits | Two 7-bits and two 8-bits | One 7-bit and one 8-bit     |        |
| Programmable logic blocks (UDBs)            | 4                        | 4               | 4                         | 8                         | 4                           |        |
| Smart I/O ports                             | None                     | 1               | None                      | None                      | None                        |        |
| Power supply range                          | 1.71 V to 5.5 V          | 1.71 V to 5.5 V | 1.71 V to 5.5 V           | 1.71 V to 5.5 V           | 1.71 V to 5.5 V             |        |
| Low-power modes                             | Deep Sleep               | 1.3 µA          | 2 µA                      | 1.3 µA                    | 1.3 µA                      | 1.5 µA |
|   | Hibernate                | 150 nA          | NA                        | 150 nA                    | 150 nA                      | 150 nA |
|   | Stop                     | 20 nA           | NA                        | 20 nA                     | 20 nA                       | 20 nA  |
| Segment LCD drive                           | 4 COM                    | None            | 4 COM                     | 8 COM                     | 4 COM                       |        |
| SCBs with programmable I2C, SPI, or UART    | 2                        | 3               | 4                         | 4                         | 2                           |        |
| TCPWM                                       | 4                        | 4               | 8                         | 8                         | 4                           |        |
| CAN   | None                     | None            | 2                         | 2                         | None                        |        |
| BLE   | None                     | None            | None                      | None                      | 4.1/4.2                     |        |
| USB Full Speed Device Controller (USB)      | None                     | None            | None                      | Yes                       | None                        |        |

(table continues...)

<sup>6)</sup> See [AN91267](#) for getting started with PSoC™ 4 Bluetooth® LE family devices.

<sup>7)</sup> IDACs are available only when CAPSENSE™ is not in use. See the respective PSoC™ 4 architecture TRM for more details.

## 3 PSoC™ 4 feature set

**Table 5** (continued) PSoC™ 4200 family features

| Features                |                                   | PSoC™ 4200              | PSoC™ 4200DS                | PSoC™ 4200M             | PSoC™ 4200L             | PSoC™ 4200 BL <sup>6)</sup>           |
|-------------------------|-----------------------------------|-------------------------|-----------------------------|-------------------------|-------------------------|---------------------------------------|
| Clocks                  | IMO                               | 3 MHz to 48 MHz         | 3 MHz to 48 MHz             | 3 MHz to 48 MHz         | 3 MHz to 48 MHz         | 3 MHz to 48 MHz                       |
|                         | ILO                               | 32 kHz                  | 40 kHz                      | 32 kHz                  | 32 kHz                  | 32 kHz                                |
|                         | WCO                               | None                    | None                        | 32 kHz                  | 32 kHz                  | 32 kHz                                |
|                         | External crystal oscillator (ECO) | None                    | None                        | 4 MHz to 33 MHz         | None                    | None                                  |
| Power supply monitoring |                                   | POR, BOD, LVD           | POR, BOD                    | POR, BOD, LVD           | POR, BOD, LVD           | POR, BOD, LVD                         |
| Supported kit           |                                   | CY8CKIT-042 pioneer kit | CY8CKIT-146 prototyping kit | CY8CKIT-044 pioneer kit | CY8CKIT-046 pioneer kit | CY8CKIT-042 Bluetooth® LE pioneer kit |
| Supported IDE           |                                   | PSoC™ Creator           | PSoC™ Creator               | PSoC™ Creator           | PSoC™ Creator           | PSoC™ Creator                         |

**Table 6** PSoC™ 4500 and PSoC™ 4700 family features

| Features                                    |            | PSoC™ 4500S                                 | PSoC™ 4700S                        |
|---|------------|---|------------------------------------|
| CM0+ CPU                                    |            | 48 MHz Cortex® -M0+                         | 48 MHz Cortex® -M0+                |
| DMA   |            | 8 channels                                  | None                               |
| Flash memory                                |            | 256 KB                                      | 32 KB                              |
| SRAM  |            | 32 KB                                       | 4 KB                               |
| GPIOs                                       |            | 53  | 36                                 |
| CAPSENSE™                                   |            | 1 channel, 52 sensors                       | 1 channel, 35 sensors              |
| MagSense                                    |            | None  | 1 channel                          |
| ADC   |            | Two 12-bits, 1-MSPS SAR ADCs with sequencer | 10-bit, 16.8-kSPS Single slope ADC |
| Opamps (programmable)                       |            | 4   | None                               |
| Comparators (low power with wakeup feature) |            | 2   | 2                                  |
| IDACs <sup>8)</sup>                         |            | Two 7-bits                                  | Two 7-bits                         |
| Smart I/O ports                             |            | 2   | 2                                  |
| Power supply range                          |            | 1.71 V to 5.5 V                             | 1.71 V to 5.5 V                    |
| Low-power modes                             | Deep Sleep | 1.3 µA                                      | 2.5 µA                             |
|   | Hibernate  | 150 nA                                      | NA                                 |
|   | Stop       | 20 nA                                       | NA                                 |
| Segment LCD drive                           |            | 4 COM                                       | 8 COM                              |

**(table continues...)**

<sup>6</sup> See [AN91267](#) for getting started with PSoC™ 4 Bluetooth® LE family devices.

<sup>8</sup> IDACs are available only when CAPSENSE™ is not in use. See the respective PSoC™ 4 architecture TRM for more details.

### 3 PSoC™ 4 feature set

**Table 6** (continued) PSoC™ 4500 and PSoC™ 4700 family features

| Features                                 |     | PSoC™ 4500S                              | PSoC™ 4700S                                |
|--|-----|--|--|
| SCBs with programmable I2C, SPI, or UART |     | 5  | 2  |
| TCPWM                                    |     | 8  | 5  |
| Motor Control Acceleration (MCA)         |     | 2  | None                                       |
| Clocks                                   | IMO | 24 MHz to 48 MHz                         | 24 MHz to 48 MHz                           |
|  | ILO | 40 kHz                                   | 40 kHz                                     |
|  | WCO | 32 kHz                                   | 32 kHz                                     |
|  | ECO | 4 MHz to 33 MHz                          | None                                       |
| Power supply monitoring                  |     | POR, BOD                                 | POR, BOD                                   |
| Supported kit                            |     | <a href="#">CY8CKIT-045S pioneer kit</a> | <a href="#">CY8CKIT-148 evaluation kit</a> |
| Supported IDE                            |     | <a href="#">PSoC™ Creator</a>            | <a href="#">PSoC™ Creator</a>              |

4 PSoC™ is more than an MCU

4 PSoC™ is more than an MCU

Figure 9 shows that a typical MCU contains a CPU (such as 8051 or an Arm® Cortex®) with a set of peripheral functions such as ADCs, DACs, UARTs, SPIs, and general I/O, all linked to the CPU’s register interface. Within the MCU, the CPU is the “heart” of the device – the CPU manages everything from setup to data movement to timing. Without the CPU, the MCU cannot function.

Figure 10 shows that PSoC™ is quite different. With PSoC™, the CPU, analog, digital, and I/O are equally important resources in a programmable system. It is the system’s interconnect and programmability that is the heart of PSoC™ – not the CPU. The peripheral analog and digital are interconnected with a highly configurable matrix of signal and data bus meshing that allows you to create custom designs that meet your application requirements. You can program PSoC™ to emulate an MCU, but you cannot program an MCU to emulate PSoC™.

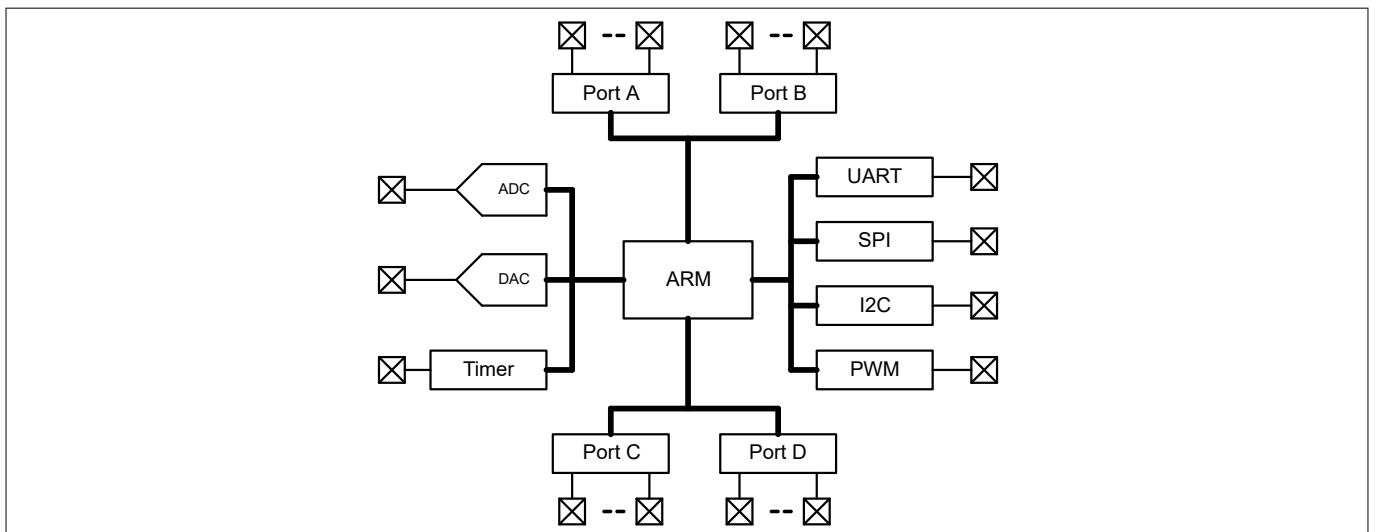

Figure 9 Typical MCU block diagram

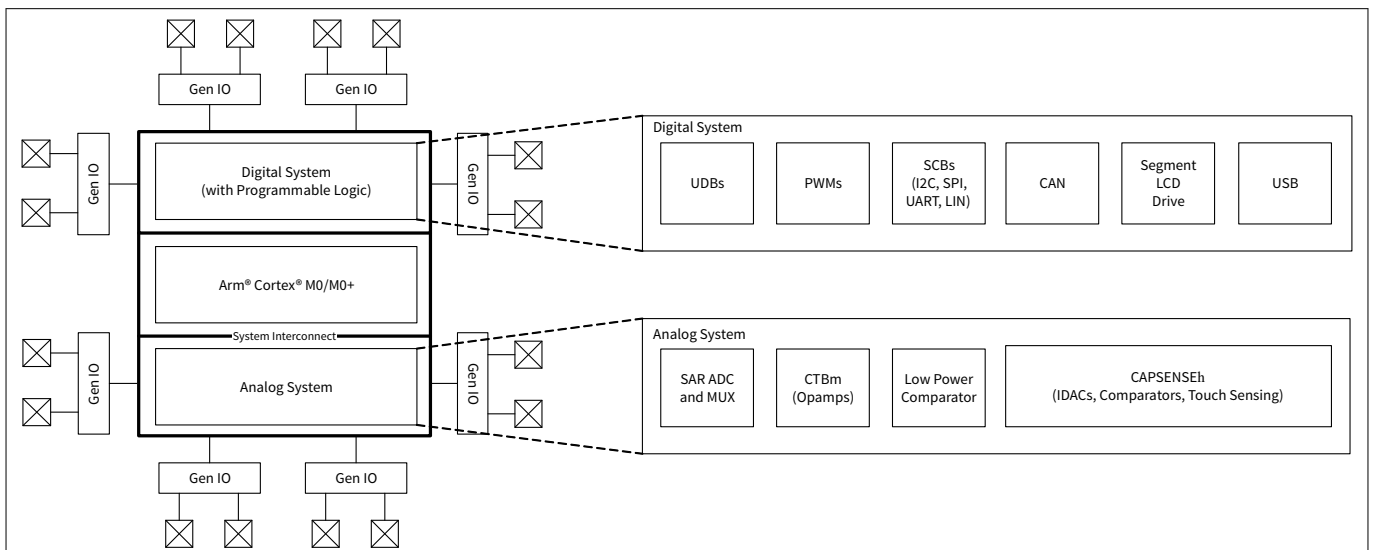

Figure 10 PSoC™ block diagram

A typical MCU requires CPU firmware to process state machines, use a timer for timing, and drive an output pin. Therefore, the functional path is always through the CPU. However, with PSoC™, asynchronous parallel processing is possible. You can configure a PSoC™ to have elements that operate independently from the CPU. The projects included with this application note demonstrate this concept. The PSoC™ is configured to make an LED blink without writing any code for the CPU as mentioned in section [Part 1: Create the design](#).

---

## 4 PSoC™ is more than an MCU

### 4.1 The concept of PSoC™ Creator Components

One other important thing about PSoC™ is the availability of PSoC™ Creator IDE. In PSoC™ Creator, different PSoC™ resources are organized as graphical elements called Components, which can be dragged and dropped onto a schematic to quickly build designs. Every peripheral in PSoC™ is available as a pre-validated PSoC™ Creator Component – PWM Component, ADC Component, DAC Component, CAPSENSE™ Component, UART Component and so on. The availability of pre-validated Components in the PSoC™ Creator significantly reduces the development time. It also allows you to quickly make changes in the design using graphical options.

For example, configuring a PWM to blink an LED in a typical microcontroller involves the following:

1. Locate the registers corresponding to the PWM block.
2. Calculate the values to be written to the PWM registers based on the required PWM period and duty cycle.
3. Write many lines of code to configure the PWM registers, set the pin drive mode, and to connect the PWM output to the pin. Many MCUs do not offer alternate pins to connect to the internal blocks.

To implement the same functionality in PSoC™ is a trivial exercise, as you will find out later in this application note. Later, if you need to reconfigure the same PWM block to a Timer, you do not need anything more than a few mouse clicks in PSoC™ Creator.

The PSoC™ also has programmable digital blocks known as Universal Digital Blocks (UDBs). PSoC™ Creator also provides several Components made of UDBs such as UART, SPI, I2C, Timer, PWM, Counter, Digital Gates (AND, OR, NOT, XOR, and so on), and many more. You can even create your own custom state machines and digital logic using the UDBs in PSoC™ Creator. The method to create your own custom PSoC™ Creator Components is provided in the [PSoC™ Creator Component author guide](#).



## 5 Getting started with PSoC™ 4 design

### 5 Getting started with PSoC™ 4 design

This section does the following:

- Demonstrate how to build a simple PSoC™ 4-based design and program it on to the development kit
- Makes it easy to learn PSoC™ 4 design techniques and how to use the ModusToolbox™ software and Eclipse IDE.

**Note:** You can use any supported IDE, but this section uses the Eclipse IDE as an example.

#### 5.1 Prerequisites

Before you get started, make sure that you have the appropriate development kit for your PSoC™ 4 product line and have installed the required software. You also need internet access to the GitHub repositories during project creation.

##### 5.1.1 Hardware

Testing this design requires one of the kits listed in [Table 7](#), which has an integrated programmer.

**Table 7** List of PSoC™ 4 pioneer kits, prototyping kits, and supported devices

| Kit name         | Kit type        | Supported device family | Part number      |
|------------------|-----------------|-------------------------|------------------|
| CY8CKIT-145      | Prototyping kit | PSoC™ 4000S             | CY8C4045AZI-S413 |
| CY8CKIT-149      | Prototyping kit | PSoC™ 4100S Plus        | CY8C4147AZI-S475 |
| CY8CKIT-041S-Max | Pioneer kit     | PSoC™ 4100S Max         | CY8C4149AZI-S598 |
| CY8CKIT-040T     | Evaluation kit  | PSoC™ 4000T             | CY8C4046LQI-T452 |
| CY8CPROTO-040T   | Prototyping kit | PSoC™ 4000T             | CY8C4046LQI-T452 |

##### 5.1.2 Software

[ModusToolbox™ software](#) 3.2 or above.

After installing the software, refer to the [ModusToolbox™ tools package user guide](#) to get an overview of the software.

#### 5.2 Using these instructions

These instructions are grouped into several sections. Each section is devoted to a phase of the application development workflow. The major sections are:

1. [Create a BSP for your board](#)
2. [Create a new application](#)
3. [View and modify the design configuration](#)
4. [Write firmware](#)
5. [Build the application](#)
6. [Program the device](#)
7. [Test your design](#)

If you are familiar with developing projects using ModusToolbox™, you can use one of the supported starter applications for your kit, such as **Hello World** or **Blinky** directly. This starter application is a complete project, which can run on supported kits without any additional code or configuration. This design is developed for the kits listed in [Table 7](#). You can test this example by selecting the appropriate kit while creating the application.

---

## 5 Getting started with PSoC™ 4 design

You can go through the instructions in the README.md file and observe how the steps are implemented in the code example.

Even if you are creating a different application from scratch following the instructions in this application note, you can use this code example as a reference.

### 5.3 About the design

This design uses the PSoC™ 4 MCU to blink an LED. On kits that support UART, the “Hello World” message is printed to the serial port stream.

### 5.4 Create a BSP for your board

All ModusToolbox™ applications require a target BSP. Infineon provides BSPs for all of our kits (including the kits mentioned in [Table 7](#)) and for each chip architecture to use as a starting point. When working with your own hardware, you can modify an Infineon BSP to match the hardware. The BSP Assistant helps to simplify the process. If you are developing for your own hardware, create a custom BSP by following the steps given in [ModusToolbox™ BSP Assistant user guide](#). Section [Opening the Device Configurator](#) describes how the configuration of the custom BSP can be edited.

### 5.5 Create a new application

This section takes you on a step-by-step guided tour of the new application process. It uses the **Empty PSoC4 App** starter application and manually adds the functionality from the **Hello World** starter application. The Eclipse IDE for ModusToolbox™ is used in the instructions, but you can use any IDE or the command line if you prefer.

If you are familiar with developing projects with ModusToolbox™ software, you can use the **Hello World** starter application directly. It is a complete design, with all the firmware written for the supported kits. You can walk through the instructions and observe how the steps are implemented in the code example.

If you start from scratch and follow all the instructions in this application note, you can use the **Hello World** code example as a reference while following the instructions.

Launch the **Dashboard 3.2** application to get started. Please note that the **Dashboard 3.2** application needs access to the internet to successfully clone the starter application onto your machine.

The **Dashboard 3.2** application helps you get started using the various tools with easy access to documentation and training material, a simple path for creating applications and creating and editing BSPs.

1. Open the **Dashboard 3.2** application.

To open the **Dashboard 3.2** application, click [ModusToolbox installation path]/tools\_3.2/dashboard/dashboard.exe

2. On the **Dashboard 3.2** window, in the right pane, in the **Target IDE** drop-down list, select **Eclipse IDE for ModusToolbox™**, and click **Launch Eclipse IDE for ModusToolbox™**.

5 Getting started with PSoC™ 4 design

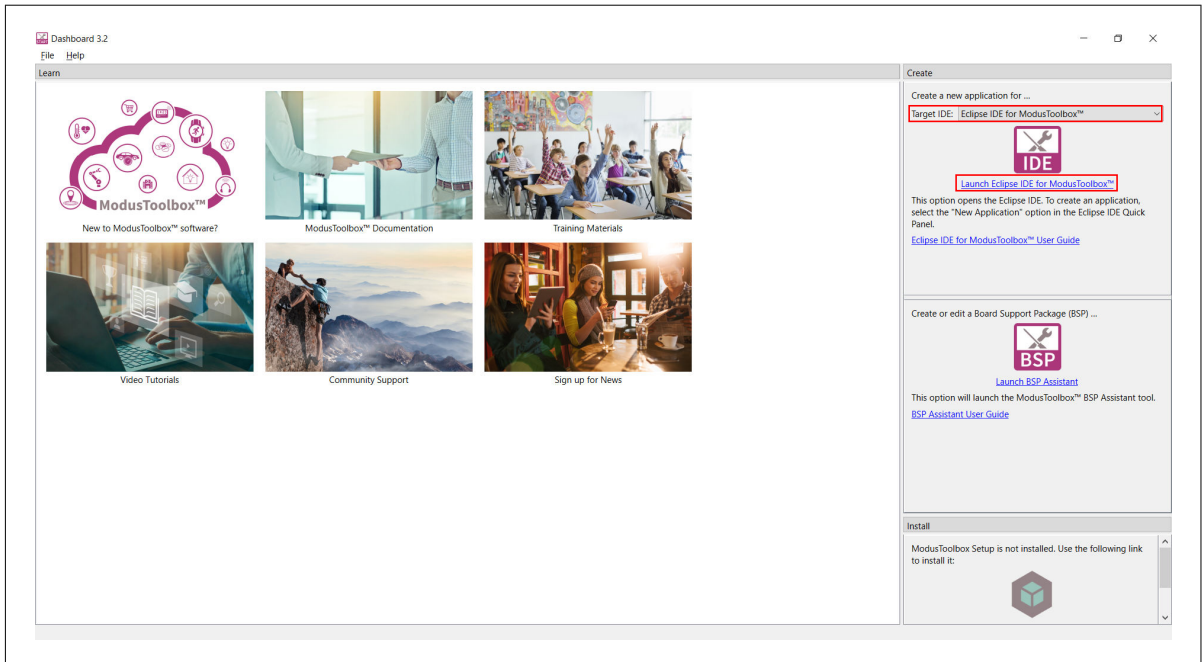

Figure 11 Dashboard 3.2 application

3. Select a new workspace.

At launch, Eclipse IDE for ModusToolbox™ presents a dialog to choose a directory for use as the workspace directory. The workspace directory is used to store workspace preferences and development artifacts. You can choose an existing empty directory by clicking the **Browse** button, as shown in the following figure. Alternatively, you can type in a directory name to be used as the workspace directory along with the complete path, and the IDE will create the directory for you.

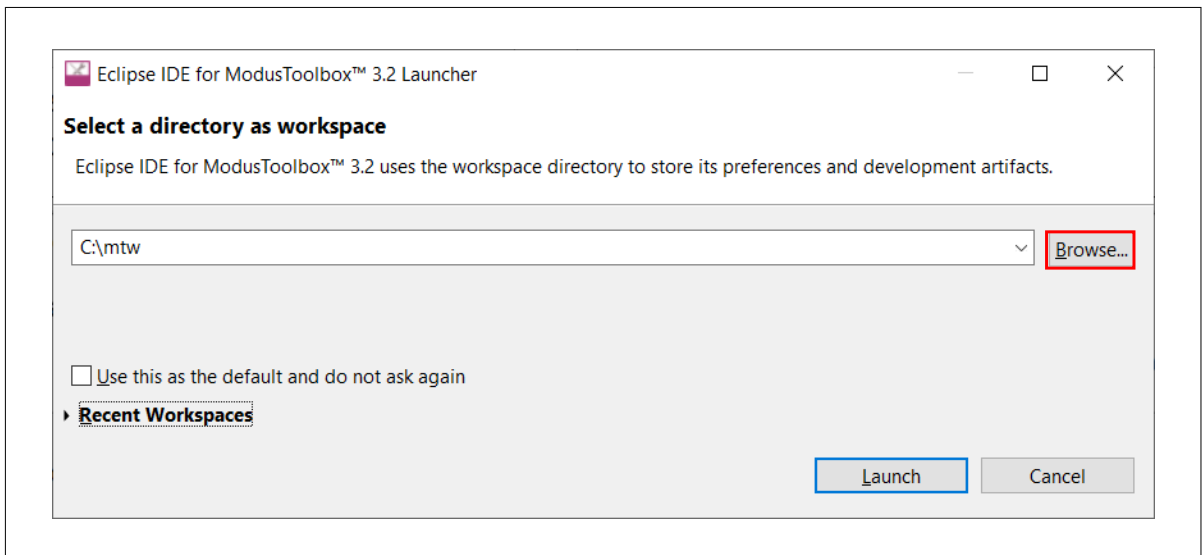

Figure 12 Select a directory as the workspace

4. Create a new ModusToolbox™ application.

- a. Click **New Application** in the Start group of the Quick Panel.
- b. Alternatively, you can choose **File > New > ModusToolbox™ Application**, as shown in the following figure.

The Project Creator opens.

## 5 Getting started with PSoC™ 4 design

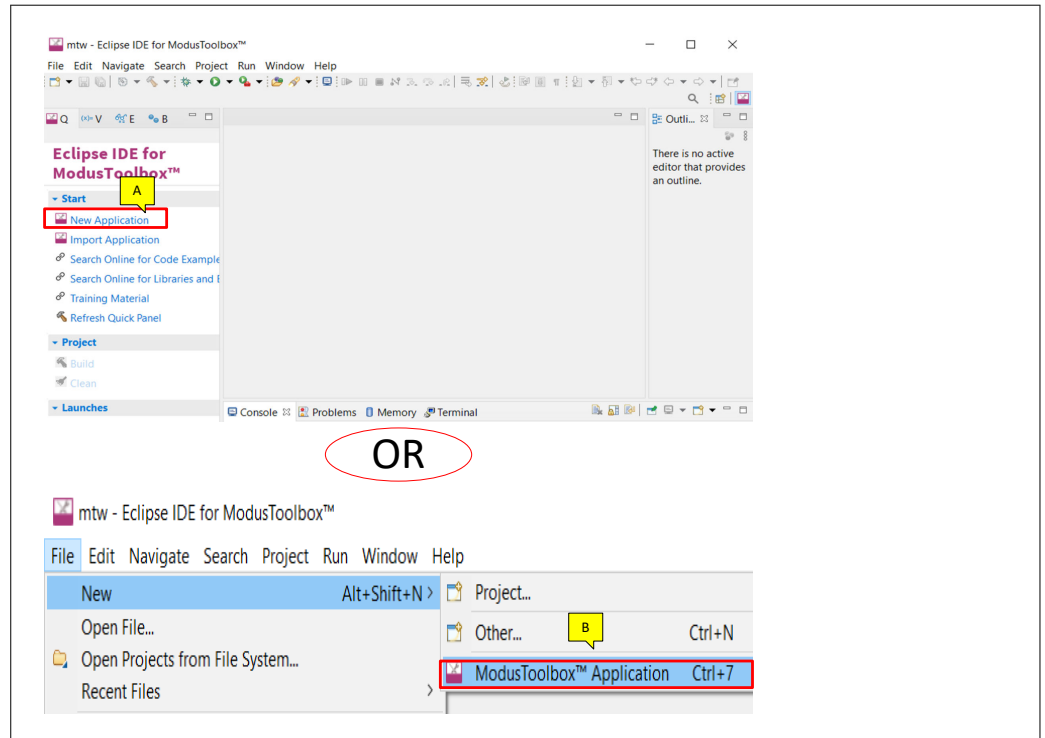

**Figure 13 Create a new ModusToolbox™ application**

### 5. Select a target PSoC™ 4 development kit

ModusToolbox™ speeds up the development process by providing BSPs that set various workspace/project options for the specified development kit in the new application dialog.

- a. In the **Choose Board Support Package (BSP)** dialog, choose the **Kit Name** that you have. The steps that follow use **CY8CKIT-041S-MAX**. See [Figure 14](#) for help with this step
- b. Click **Next**

5 Getting started with PSoC™ 4 design

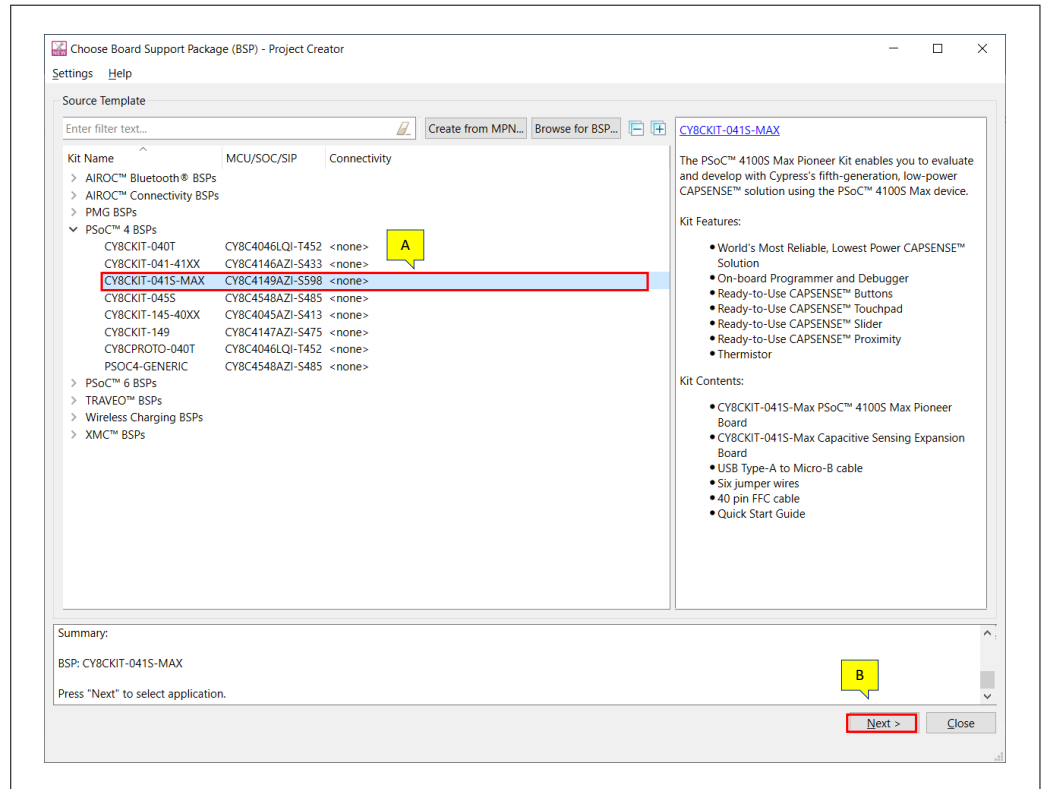

**Figure 14 Choose target hardware**

- c. In the **Select Application** dialog, select **Empty App** starter application, as shown in the following figure.
- d. In the **Name** field, type in a name for the application, such as **Hello\_World**. You can choose to leave the default name if you prefer.
- e. Click **Create** to create the application, as shown in the following figure, wait for the Project Creator to automatically close once the project is successfully created.

## 5 Getting started with PSoC™ 4 design

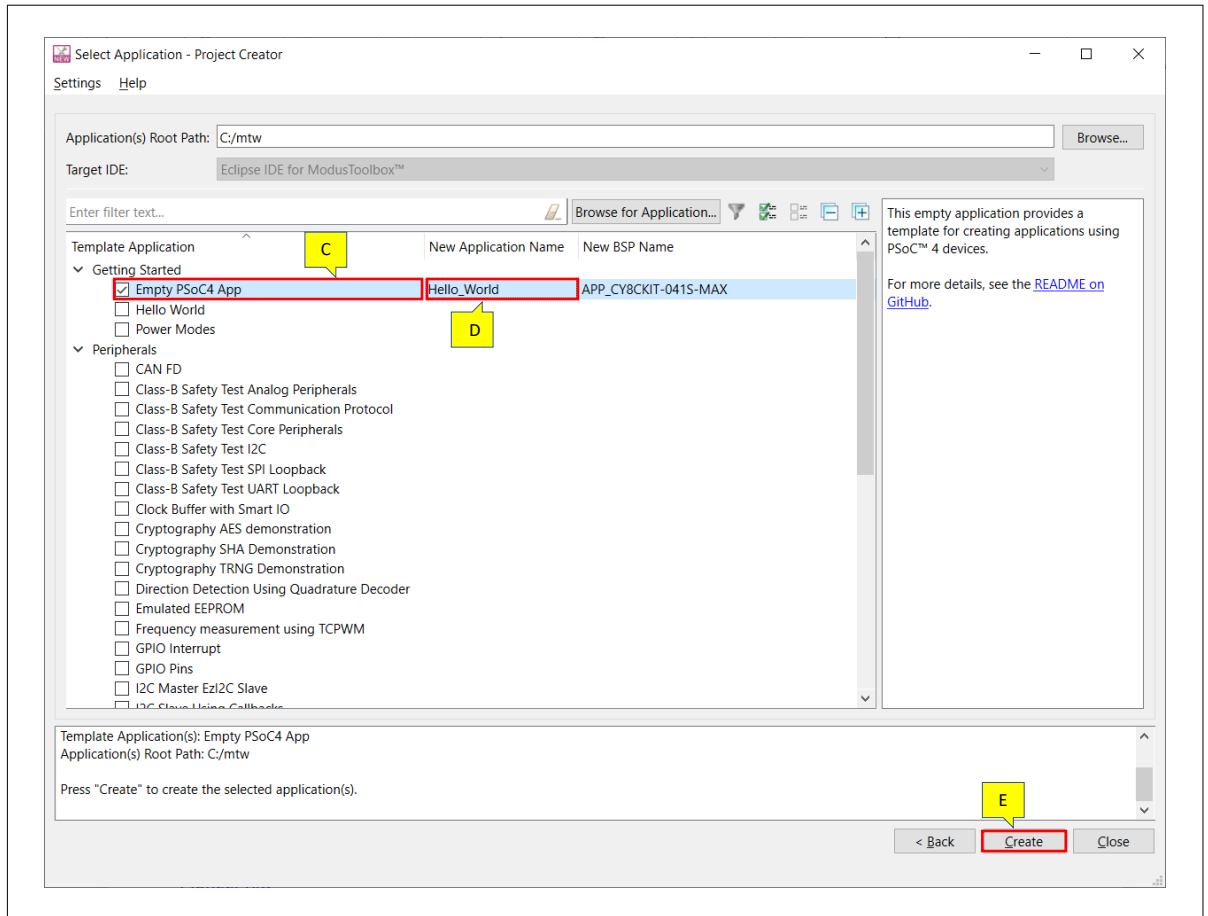

**Figure 15 Choose starter application**

You have successfully created a new ModusToolbox™ application for a PSoC™ 4.

The BSP uses CY8C4149AZI-S598 as the default device that is mounted on the [PSoC™ 4 CY8CKIT-041S-Max Pioneer Kit](#).

If you are using custom hardware based on PSoC™ 4, or a different PSoC™ 4 part number, please refer to the [Create a BSP for your board](#) or the [BSP Assistant user guide](#).

### 5.6 View and modify the design configuration

[Figure 16](#) shows the ModusToolbox™ Project Explorer displaying the structure of the application project.

## 5 Getting started with PSoC™ 4 design

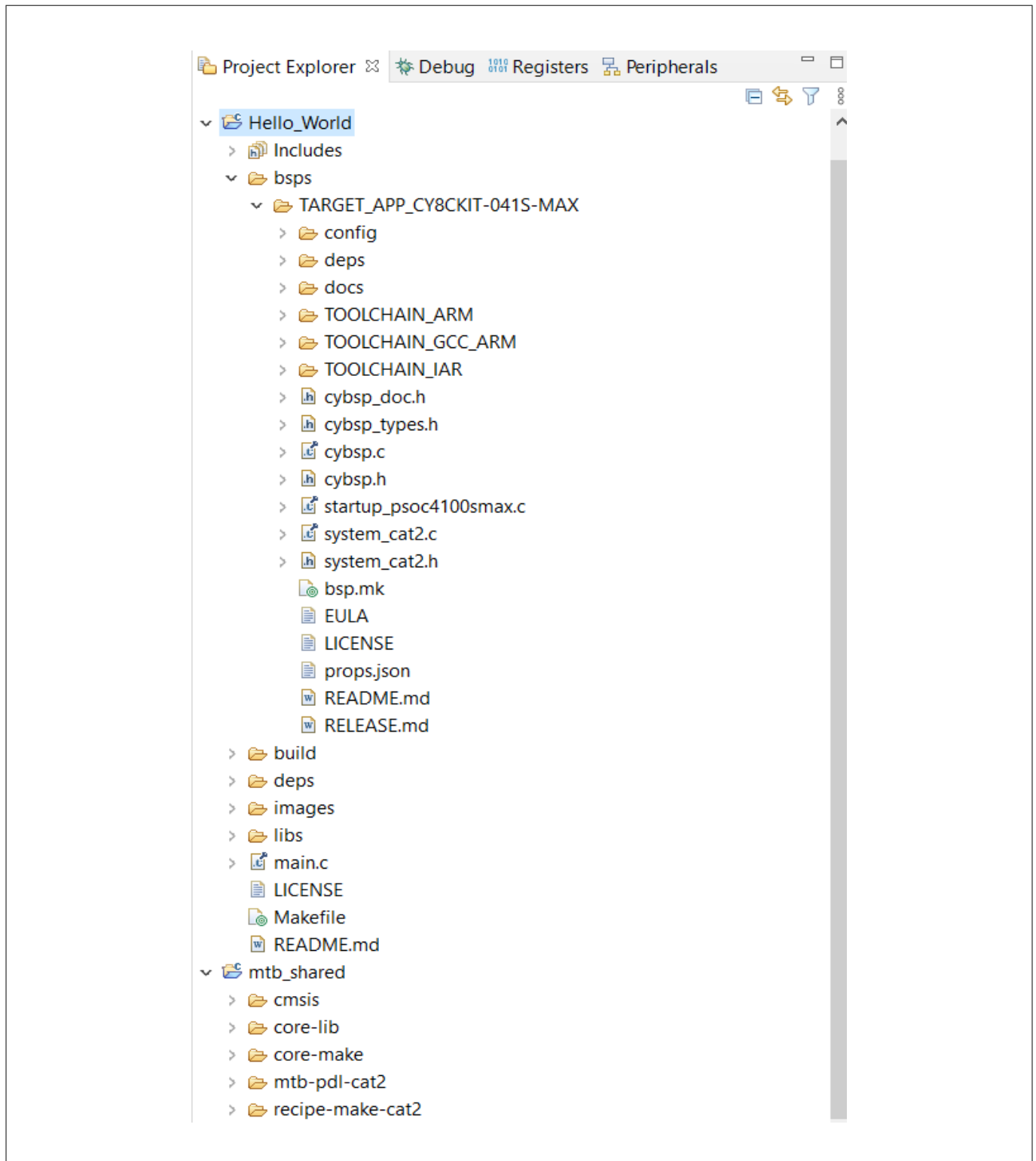

**Figure 16** Project explorer view

For understanding the files and folders in detail, see Section 2.4.2 in [ModusToolbox™ tools package user guide](#).

5 Getting started with PSoC™ 4 design

5.6.1 Opening the Device Configurator

You can modify the device configurations which is loaded by the selected BSP. For example, default kit BSPs do not have UART enabled. Below steps show how to enable UART peripheral for “Hello World” printing operation and how to enable User LED for PSoC™ 4 kits.

- As shown in Figure 17, click **Device configurator** in the **Quick Panel** under the **BSP Configurators** section. This opens the Device Configurator dialog (Figure 18). You can also open the other configurators and configure as required.

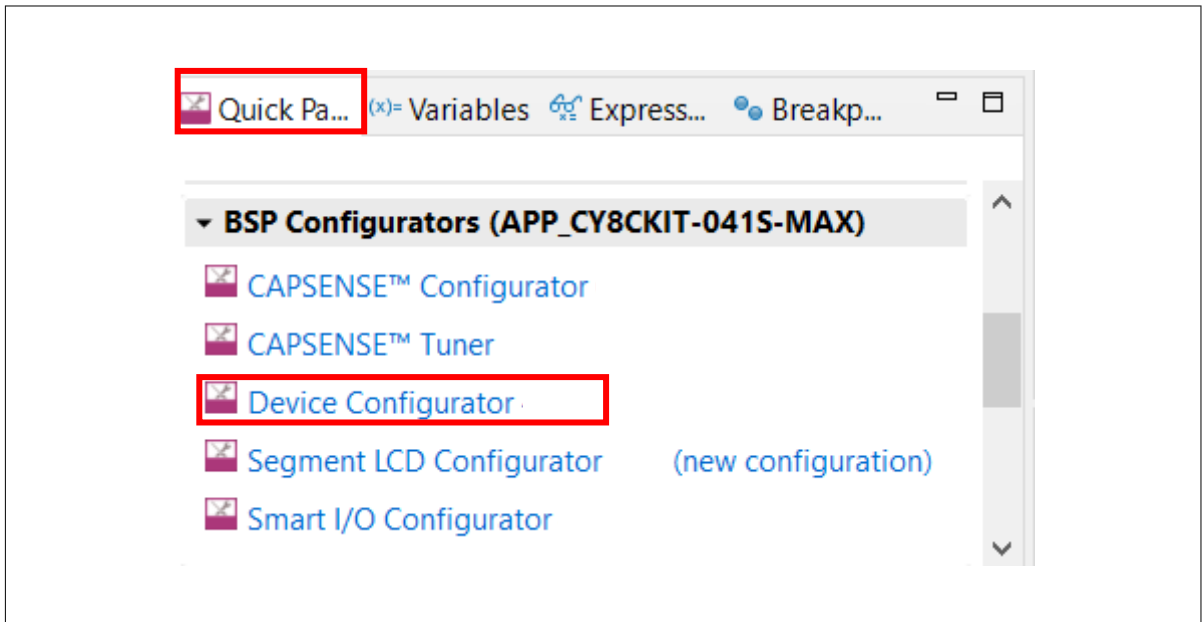

Figure 17 Opening the Device Configurator

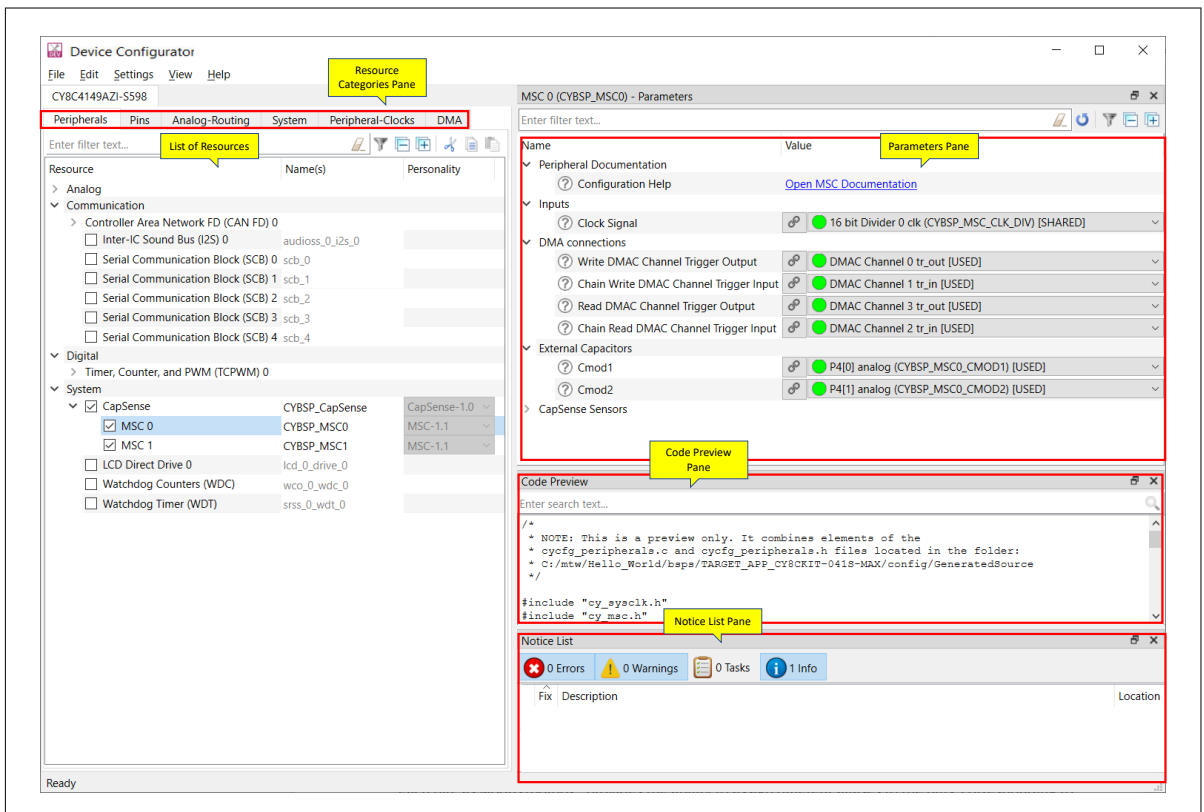

Figure 18 Overview of design.modus



5 Getting started with PSoC™ 4 design

From the **Resource Categories Pane** of the **Device Configurator** dialog, you can choose different resources to configure, such as peripherals, pins, and clocks.

The **Peripherals** tab shows a list of available peripherals in the device. The configuration in the **Personality** column defines the behavior of the resource. For example, a **Serial Communication Block (SCB)** resource can have **EZIC, I2C, SPI, or UART** as personalities. The **Name(s)** field is the user-defined name of the resource, which is used in firmware development. You can specify one or more names for each pin, as ModusToolbox™ provides the ability to assign different aliases to the pins, corresponding to different run-time configurations. Note that the listed names must be separated by commas with no space.

In the **Parameters** pane, you can enter the configuration parameters for each enabled resource and the selected personality. The **Code Preview** pane shows the configuration code generated for the selected configuration parameters. This code is populated in the `cycfg_` files in the GeneratedSource folder. Any errors, warnings, and information messages, caused by the configuration, are displayed in the **Notice List** pane.

2. Enable UART peripheral and configure the corresponding clocks as explained in the following steps:

**Note:** For the CY8CKIT-040T kit skip these steps because UART is not supported on this kit.

- a. Go to the **Peripherals** tab in **Resources Categories** pane and enable **Serial Communication Block (SCB) 1**, set personality as UART-1.0 and the name as "CYBSP\_UART". In [Figure 19](#), SCB instance 1 is selected based on Rx/Tx pin required for the kit. As shown in [Figure 20](#), the drop-down of Rx and Tx configuration parameters shows pins supported by SCB 1. See the [device datasheet](#) for the pins available for each SCB instance.

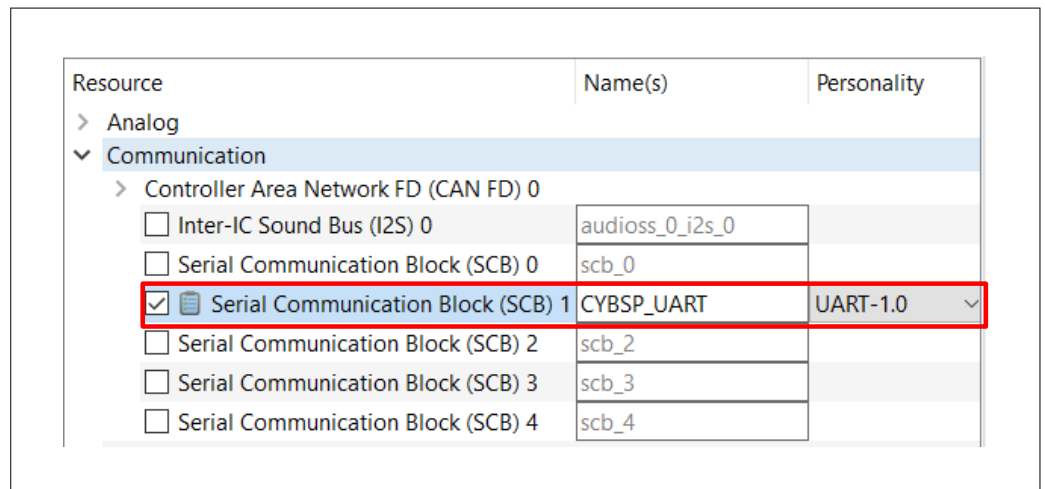

**Figure 19 Enabling SCB as UART**

- b. Set the required configuration parameters such as **Clock, Rx, and Tx** in the **Parameter** pane. Retain the default values for other parameters.

5 Getting started with PSoC™ 4 design

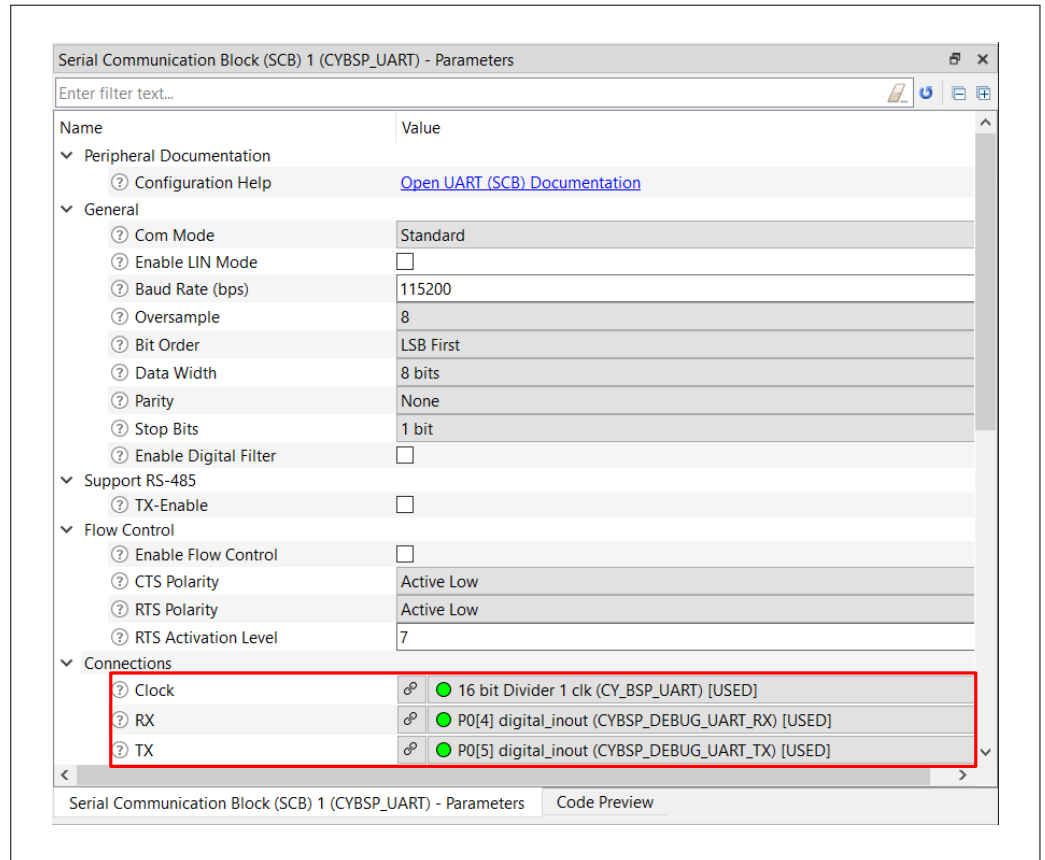

**Figure 20** Setting UART configuration parameter

- c. Go to the **Peripheral-Clocks** tab in **Resource Categories** pane to configure the clock for UART peripheral.

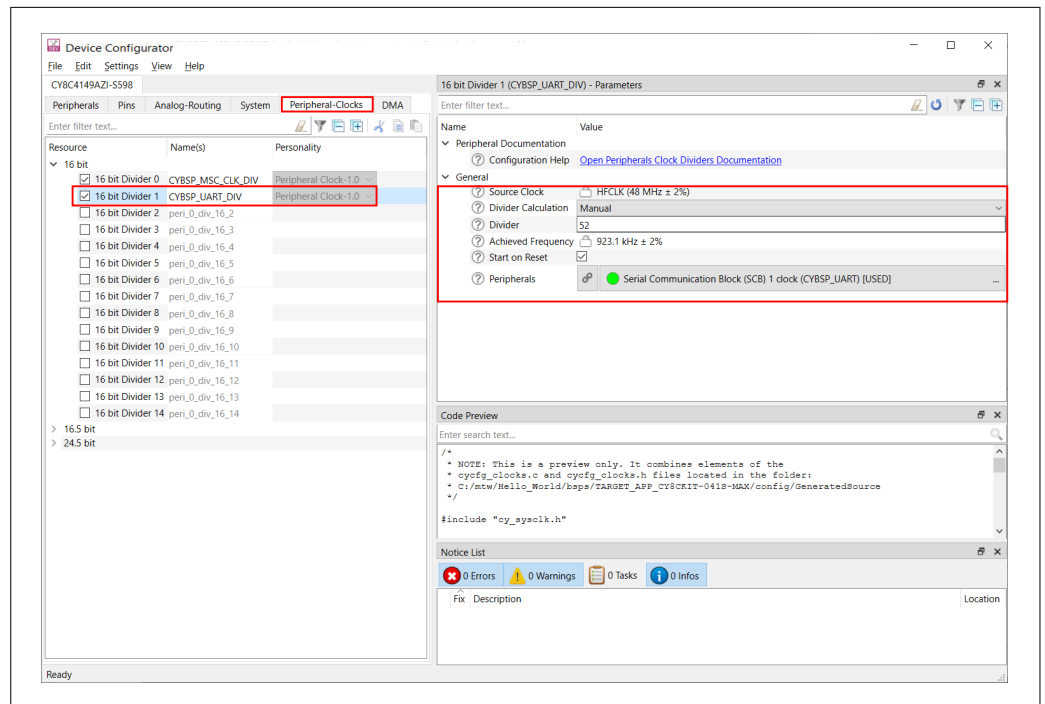

**Figure 21** Configuring clock

*Tip:* Go to the **Code Preview** pane to preview the generated code.

5 Getting started with PSoC™ 4 design

```

Code Preview
Enter search text...

/* NOTE: This is a preview only. It combines elements of the
 * cycfg_peripherals.c and cycfg_peripherals.h files located in the folder
 * C:/mtw/Hello_World/bsps/TARGET_APP_CY8CKIT-0418-MAX/COMPONENT_BSP_DESIGN_MODUS/GeneratedSou
 */

#include "cy_scb_uart.h"
#include "cy_sysclk.h"
#if defined (CY_USING_HAL)
    #include "cyhal_hwmgr.h"
#endif //defined (CY_USING_HAL)

#define CYBSP_UART_HW SCB1
#define CYBSP_UART_IRQ scb_1_interrupt_IRQn

const cy_stc_scb_uart_config_t CYBSP_UART_config =
{
    .uartMode = CY_SCB_UART_STANDARD,
    .enableMutliProcessorMode = false,
    .smartCardRetryOnNack = false,
    .irdaInvertRx = false,
    .irdaEnableLowPowerReceiver = false,
    .enableLinMode = false,
    .oversample = 8,
    .enableMsbFirst = false,
    .dataWidth = 8UL,
    .parity = CY_SCB_UART_PARITY_NONE,
    .stopBits = CY_SCB_UART_STOP_BITS_1,
    .enableInputFilter = false,
    .breakWidth = 11UL,
    .breakLevel = false,
    .dropOnFrameError = false,
    .dropOnParityError = false,
    .receiverAddress = 0x00UL,
    .receiverAddressMask = 0x00UL,
    .acceptAddrInFifo = false,
    .enableCts = false,
}
    
```

Figure 22 Code preview pane

- Go to the **Pins** tab in **Resource Categories** pane to configure the GPIO connected to the user LED on the kit. See [Table 8](#) if you are using a different PSoC™ 4 kit. Configure the GPIO as shown in [Figure 23](#).

Figure 23 Configuring GPIO

5 Getting started with PSoC™ 4 design

**Table 8 Pin mapping table across PSoC™ 4 kits**

| Function | CY8CKIT-145(PS oC™ 4000S) | CY8CKIT-149(PS oC™ 4100S Plus) | CY8CKIT-041S-MAX(PSoC™ 4100S Max) | CY8CKIT-040T PSoC™ 4000T CAPSENSE™ Evaluation Kit | CY8CPROTO-040T PSoC™ 4000T CAPSENSE™ Prototyping Kit |
|----------|---------------------------|--------------------------------|-----------------------------------|---|--|
| User LED | P2[5]                     | P3[4]                          | P7[3]                             | P4[0]   | 1[0], 3[0]   |

- Disable (i.e., uncheck) any other peripherals and pins that may have been enabled by default for the kit.
- Other resources like power, frequency and clock can be configured in the System tab of the Resource Categories Pane. Default Power settings are shown in Figure 24. For this design, no further changes are required.

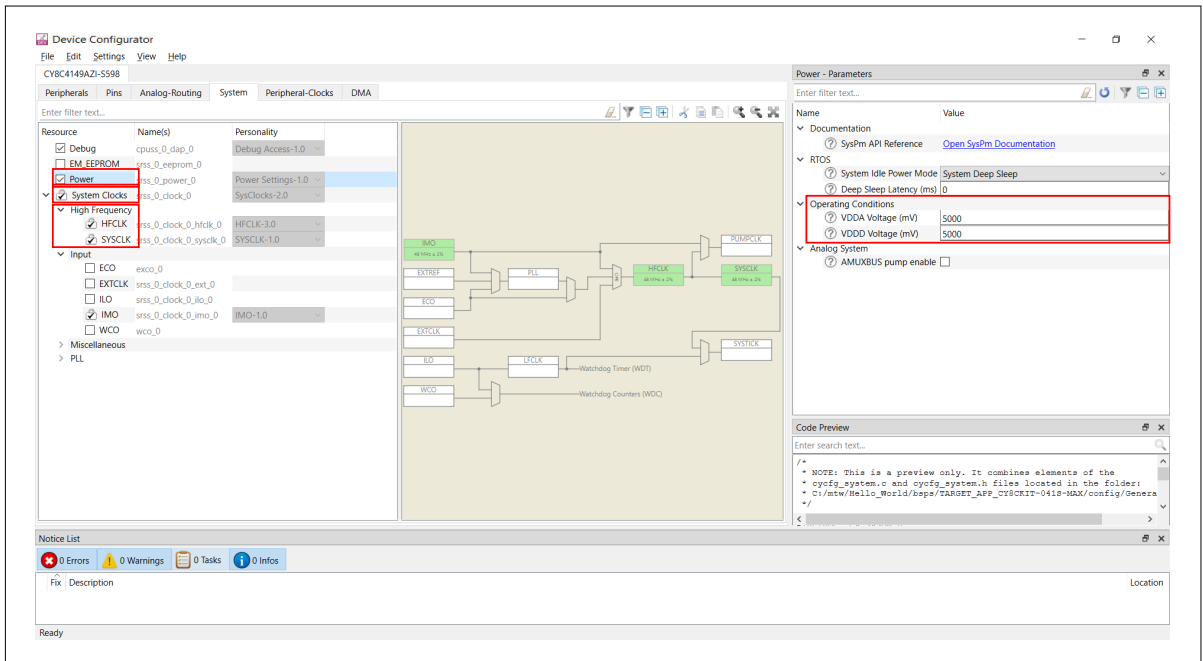

**Figure 24 Configuring System Settings**

- Go to **File > Save** or press **[Ctrl]+[S]** to save the configuration and to generate the source code in the GeneratedSource folder.

**5.7 Write firmware**

This design uses the CM0+ CPU of the PSoC™ 4 to execute two tasks: UART communication and LED control. The CM0+ CPU uses the UART to print the “Hello World” message to the serial port stream and to make the user LED on the kit blink.

If you are using the **Empty PSoC™ 4** starter application, you can copy the code snippet provided in this section, to the main.c file of the application project. If you are using the **Hello World** code example, the required files are already in the application.

**Firmware flow**

This section explains the code in the main.c file of the application.

In this example, the CM0+ CPU comes out of reset and performs resource initialization. It configures the system clocks, pins, clock to peripheral connections, and other platform resources.

The clocks and system resources are initialized by the BSP initialization function. PDL functions are used to configure and enable the UART peripheral. The UART prints “Hello World” message on the terminal emulator –

---

### 5 Getting started with PSoC™ 4 design

the onboard KitProg3 acts as the USB-UART bridge to create the virtual COM port. An infinite FOR loop, with a software delay, is used to toggle the user LED periodically.

Note that the application code uses BSP/PDL functions to execute the intended functionality.

- `cybsp_init()`- This BSP function initializes the system resources of the device including but not limited to the system clocks and power regulators.
- `Cy_SCB_UART_Init()`- This PDL function initializes the SCB block for UART operation. A configuration structure, `CYBSP_UART_config`, is used as a parameter for this function to configure the UART. This structure is autogenerated by `design.modus` based on the applied configuration.
- `Cy_SCB_UART_Enable()`- This PDL function enables the SCB block for UART operation.
- `Cy_SCB_UART_PutString()`- This PDL function places a NULL terminated string in the UART TX FIFO.
- `Cy_GPIO_Inv()`- This PDL function sets a pin output logic state to the inverse of the current output logic state.
- `Cy_SysLib_Delay()`- This PDL function inserts a delay (specified in milliseconds).

Copy [Code Listing 1](#) or [Code Listing 2](#), as applicable, to the `main.c` of your application project.

## 5 Getting started with PSoC™ 4 design

### Code Listing 1 Code snippet with UART communication (main.c) (Use for all kits other than CY8CKIT-040T)

```

/*****
 * Include header files
 *****/
#include "cy_pdl.h"
#include "cybsp.h"

/*****
 * Macros
 *****/
#define LED_DELAY_MS          (500u)
#define CY_ASSERT_FAILED     (0u)
/*****
 * Function Name: main
 *****/
 * Summary:
 * System entrance point. This function performs
 * - initial setup of device
 * - configure the SCB block as UART interface
 * - prints out "Hello World" via UART interface
 * - Blinks an LED under firmware control at 1 Hz
 *
 * Parameters:
 * none
 *
 * Return:
 * int
 *
 *****/
int main(void)
{
    cy_rslt_t result;

    cy_stc_scb_uart_context_t CYBSP_UART_context;

    /* Initialize the device and board peripherals */
    result = cybsp_init();

    /* Board init failed. Stop program execution */
    if (result != CY_RSLT_SUCCESS)
    {
        CY_ASSERT(CY_ASSERT_FAILED);
    }

    /* Configure and enable the UART peripheral */
    Cy_SCB_UART_Init(CYBSP_UART_HW, &CYBSP_UART_config, &CYBSP_UART_context);
    Cy_SCB_UART_Enable(CYBSP_UART_HW);

    /* Enable global interrupts */
    __enable_irq();

```

## 5 Getting started with PSoC™ 4 design

```
/* Send a string over serial terminal */  
Cy_SCB_UART_PutString(CYBSP_UART_HW, "Hello world\r\n");  
  
for(;;)  
{  
    /* Toggle the user LED state */  
    Cy_GPIO_Inv(CYBSP_USER_LED1_PORT, CYBSP_USER_LED1_PIN);  
  
    /* Wait for 0.5 seconds */  
    Cy_SysLib_Delay(LED_DELAY_MS);  
}  
}
```

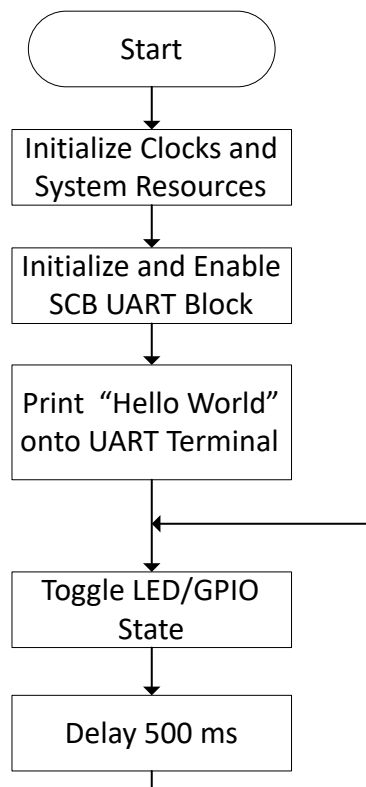

**Figure 25** Firmware flowchart

## 5 Getting started with PSoC™ 4 design

### Code Listing 2 Code snippet without UART communication (main.c) (Use for any kit including CY8CKIT-040T)

```

/*****
 * Include header files
 *****/
#include "cy_pd1.h"
#include "cybsp.h"

/*****
 * Macros
 *****/
#define LED_DELAY_MS      (500u)
#define CY_ASSERT_FAILED (0u)

/*****
 * Function Name: main
 *****/
* Summary:
 * System entrance point. This function performs
 * - initial setup of device
 * - Blinks an LED under firmware control at 1 Hz
 *
 * Parameters:
 * none
 *
 * Return:
 * int
 *
 *****/
int main(void)
{
    cy_rslt_t result;

    /* Initialize the device and board peripherals */
    result = cybsp_init();

    /* Board init failed. Stop program execution */
    if (result != CY_RSLT_SUCCESS)
    {
        CY_ASSERT(CY_ASSERT_FAILED);
    }

    /* Enable global interrupts */
    __enable_irq();

    for(;;)
    {
        /* Toggle the user LED state */
        Cy_GPIO_Inv(CYBSP_USER_LED1_PORT, CYBSP_USER_LED1_PIN);

        /* Wait for 0.5 seconds */
        Cy_SysLib_Delay(LED_DELAY_MS);
    }
}

```



5 Getting started with PSoC™ 4 design

```

}
}
    
```

This summarizes how the firmware works in the code example. For details, explore the source files.

5.8 Build the application

This section explains how to build the application.

1. Select the application project in the Project Explorer window and click the **Build <name> Application** shortcut under the **<name>** group in the Quick Panel. It uses the selected build configuration and compiles/links all projects that constitute the application.
2. The **Console** view lists the results of the build operation.

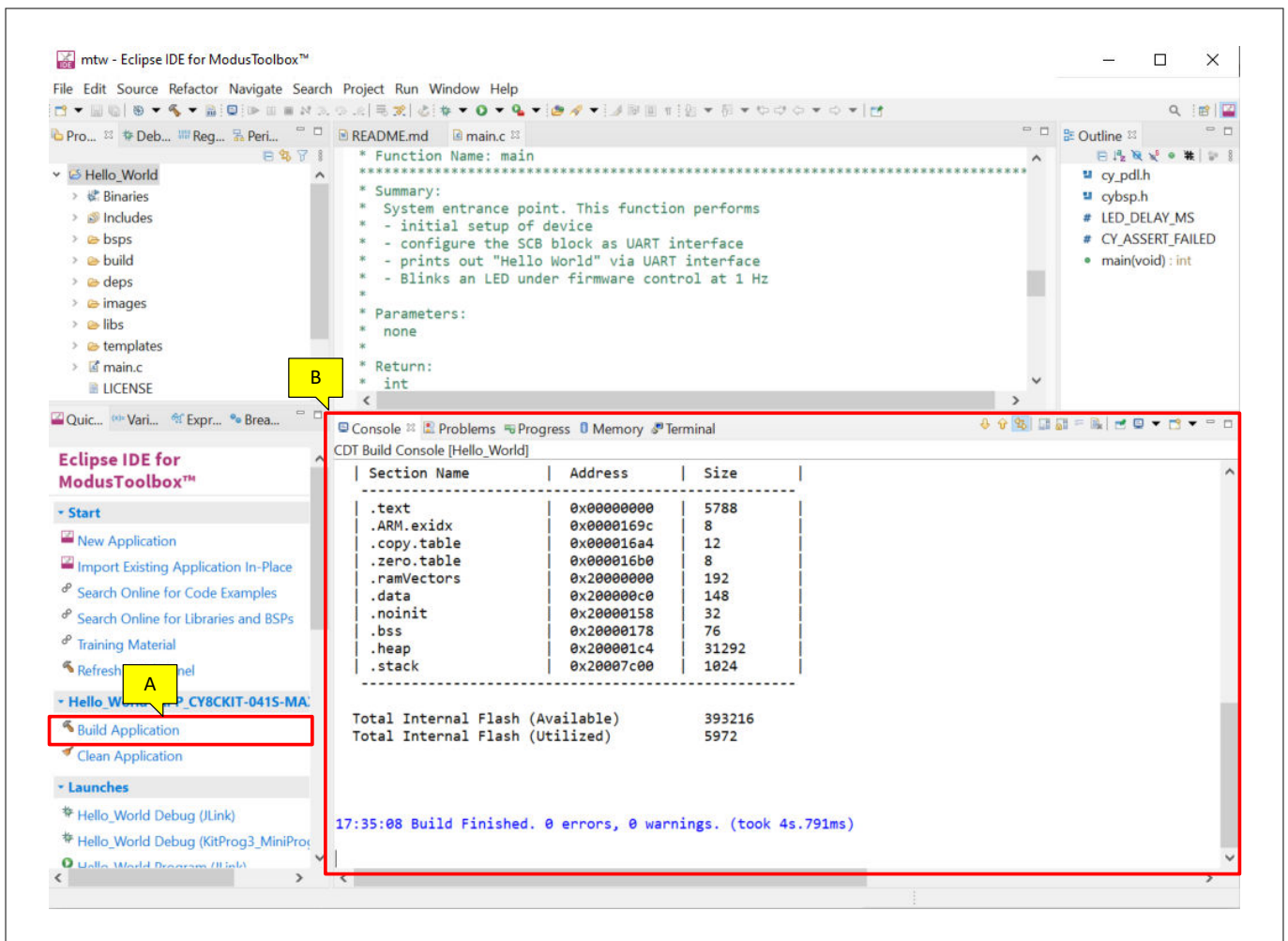

Figure 26 Build the application

If there are any errors, check the steps and make sure that you complete all required tasks.

**Note:** You can also use the CLI to build the application. See the "3.5.3 Use command line" section in the [ModusToolbox™ user guide](#). This document is located in the `/ide_3.2/docs/` folder in the `ModusToolbox™` installation directory.

### 5.9 Program the device

This section explains how to program the PSoC™ 4 device.

ModusToolbox™ uses the SWD protocol to program and debug applications on PSoC™4 devices. For ModusToolbox™ to identify the device on the kit, the kit must be running KitProg3. Some kits are shipped with KitProg2 firmware instead of KitProg3. ModusToolbox™ includes the fw-loader command-line tool to switch the KitProg firmware from KitProg2 to KitProg3. See section 5.1.10 KitProg Firmware Loader in the [ModusToolbox™ IDE user guide](#) for more details.

If you are developing hardware on your own, you may need a hardware programmer/debugger; for example, [CY8CKIT-005 MiniProg4](#).

1. Connect the kit to the USB port of your computer
2. Select the application project and click the **<application name> Program (KitProg3\_MiniProg4)** shortcut under the **Launches** group in the Quick Panel. The IDE will select and run the appropriate run configuration. Note that this step will also perform a build if any files have been modified since the last build.

5 Getting started with PSoC™ 4 design

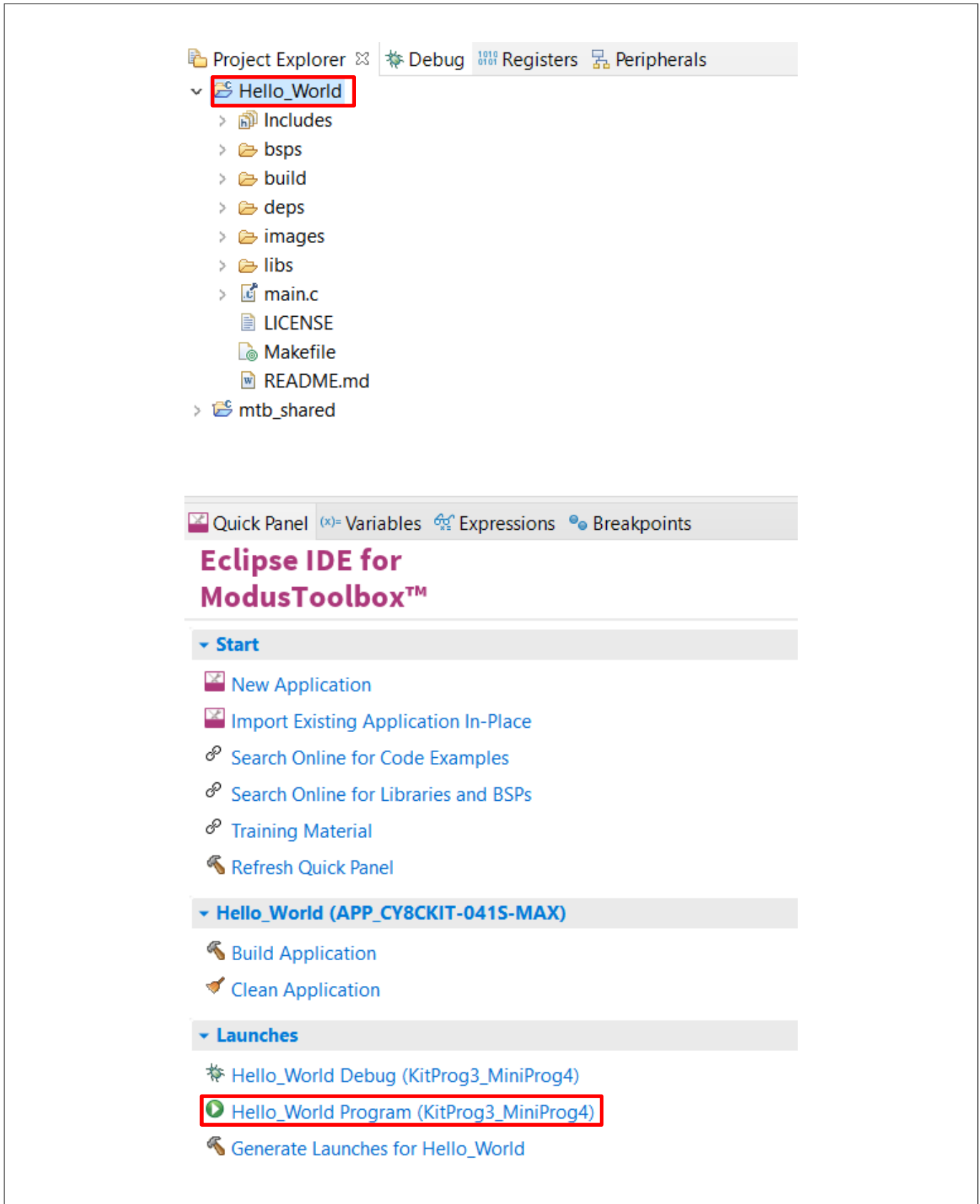

Figure 27 Programming an application to a device

The Console view lists the results of the programming operation.

5 Getting started with PSoC™ 4 design

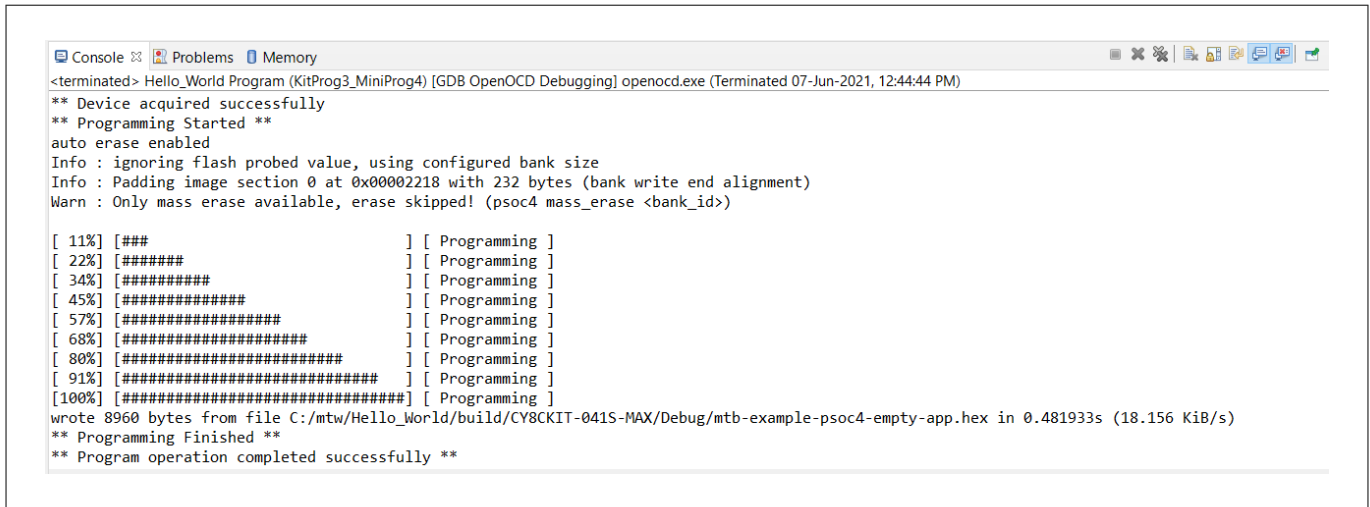

Figure 28 Console – programming results

5.10 Test your design

This section describes how to test your design.

Once the programming is done, reset the kit and observe the LED blinking.

For kits having UART enabled, follow these steps to observe the "Hello world" being printed. This application note uses Tera Term as the UART terminal emulator to view the results. You can use any terminal to view the output. Skip these steps for CY8CKIT-040T kit as UART is not supported for this kit.

1. Select the serial port

Launch Tera Term and select the USB-UART COM port as shown in Figure 29. Note that your COM port number may be different.

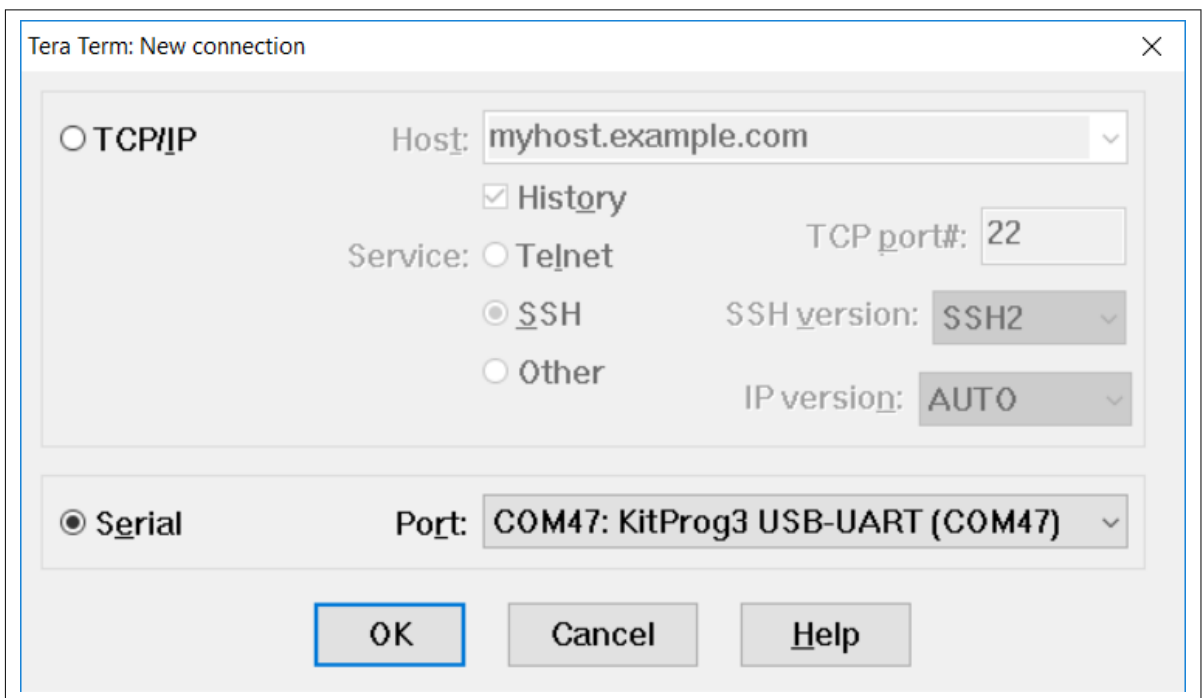

Figure 29 Selecting the KitProg3 COM port in Tera Term

2. Set the baud rate

Go to Setup > Serial port. Set the baud rate to 115200.

5 Getting started with PSoC™ 4 design

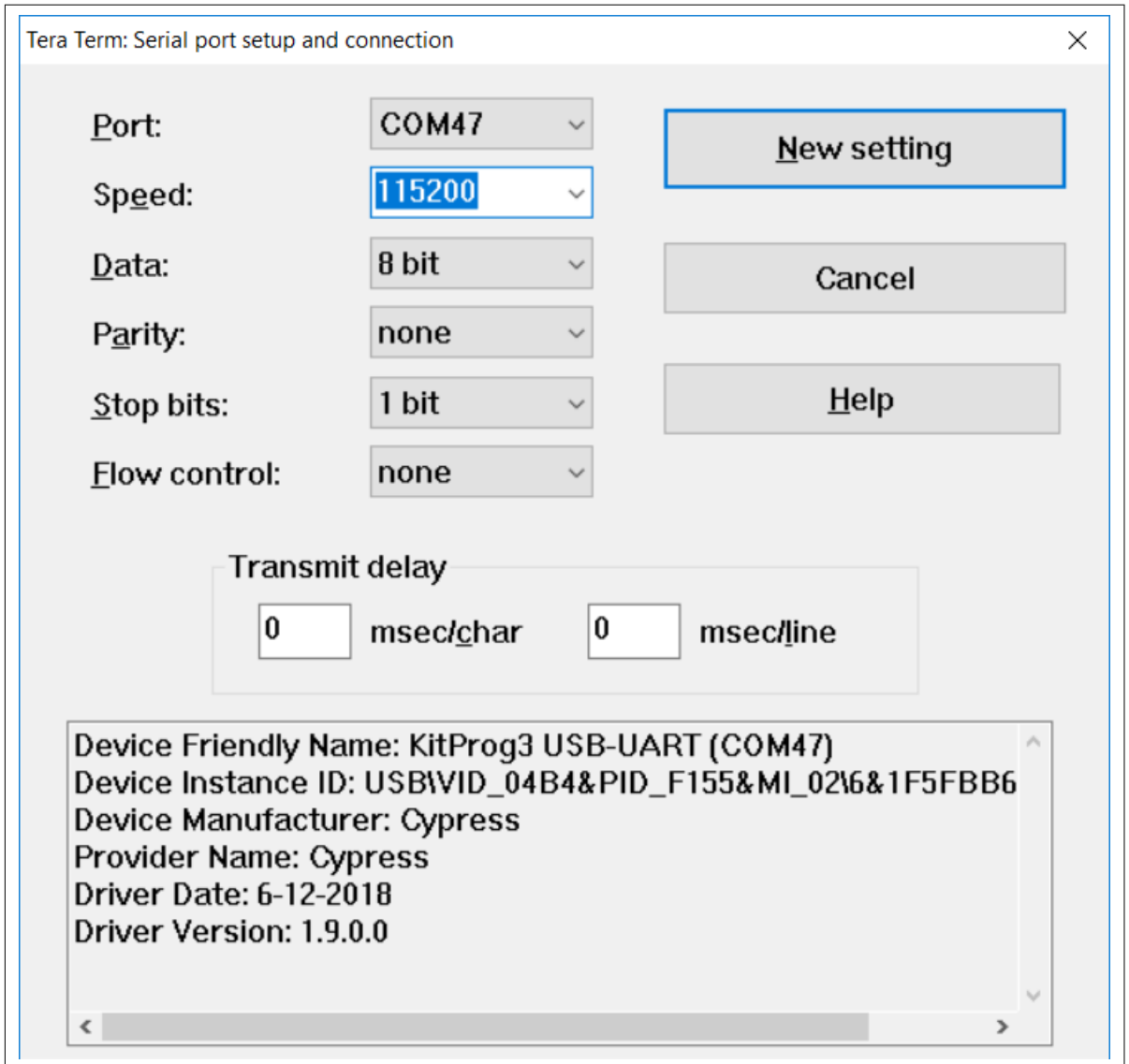

Figure 30 Configuring the baud rate in Tera Term

3. Reset the device

Press the reset switch on the (See Table 9) PSoC™ 4 kit. A "Hello world" message appears on the terminal. The user LED on the kit will start blinking.

Table 9 Pin mapping table across PSoC™ 4 kits for reset switch

| Function | CY8CKIT-145(PSoC™ 4000S) | CY8CKIT-149(PSoC™ 4100S Plus) | CY8CKIT-041S-MAX(PSoC™ 4100S Max) | CY8CKIT-040T PSoC™ 4000T CAPSENSE™ Evaluation Kit | CY8CPROTO-040T PSoC™ 4000T CAPSENSE™ Prototyping Kit |
|----------|--------------------------|-------------------------------|-----------------------------------|---|--|
| RESET    | SW1                      | SW2                           | SW1                               | SW1   | SW1  |

## 5 Getting started with PSoC™ 4 design

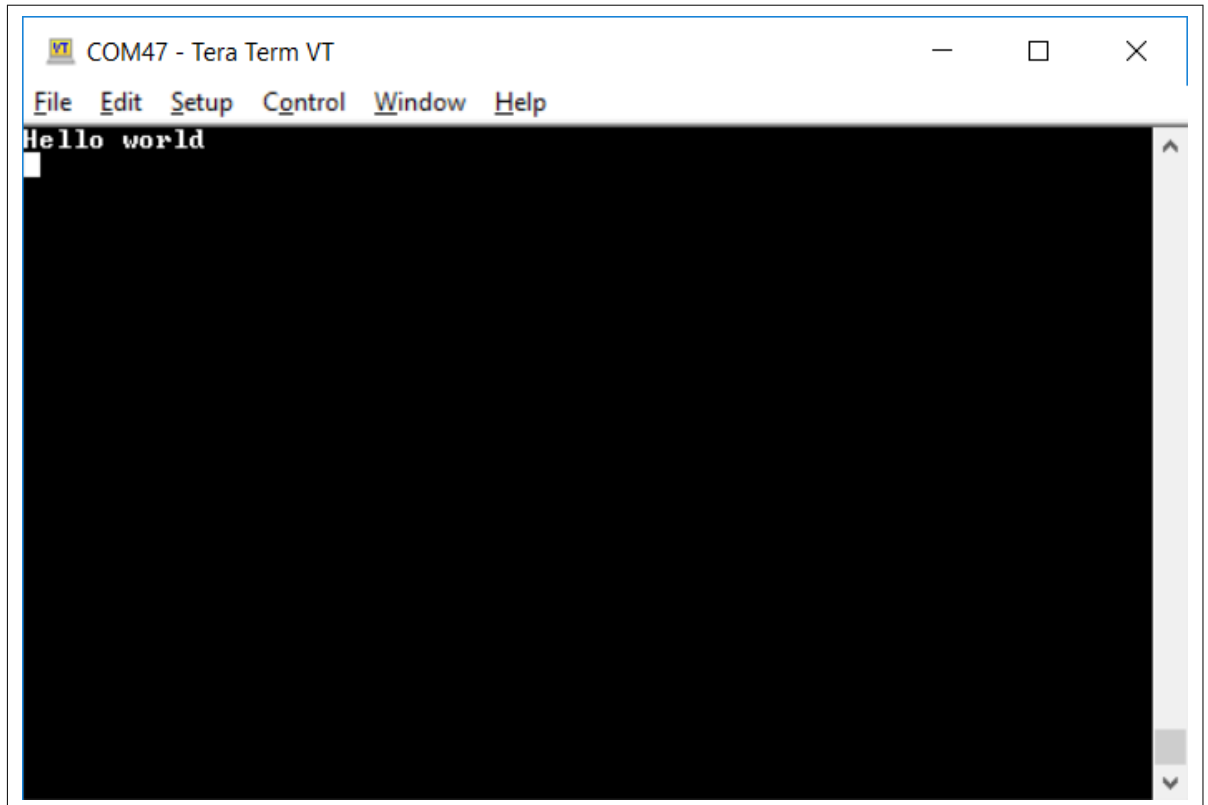

**Figure 31**                      **UART message printed from PSoC™ 4**

## 6 My first PSoC™ 4 design using PSoC™ Creator

### 6 My first PSoC™ 4 design using PSoC™ Creator

This section:

- Demonstrates how PSoC™ can be programmed to do more than a traditional MCU
- Shows how to build a simple PSoC™ design and install it in a development kit.
- Provides detailed steps that make it easy to learn PSoC™ design techniques and how to use [PSoC™ Creator](#).

#### 6.1 Before you begin

##### 6.1.1 Have you installed PSoC™ Creator?

Download and install PSoC™ Creator from the [PSoC™ Creator](#) home page. Note that the installation of the toolset may take a long time – see the PSoC™ Creator Release Notes for more information.

##### 6.1.2 Do you have a development kit or prototyping kit?

Testing this design requires one of the kits listed in [Table 10](#), which has an integrated programmer.

**Table 10 List of PSoC™ 4 pioneer kits, prototyping kits, and supported Devices**

| Kit name                        | Kit type        | Supported device family  | Part number       |
|---------------------------------|-----------------|--------------------------|-------------------|
| <a href="#">CY8CKIT-040</a>     | Pioneer kit     | PSoC™ 4000               | CY8C4014LQI-422   |
| <a href="#">CY8CKIT-042</a>     | Pioneer kit     | PSoC™ 4200               | CY8C4245AXI-483   |
| <a href="#">CY8CKIT-044</a>     | Pioneer kit     | PSoC™ 4200M              | CY8C4247AZI-M485  |
| <a href="#">CY8CKIT-046</a>     | Pioneer kit     | PSoC™ 4200L              | CY8C4248BZI-L489  |
| <a href="#">CY8CKIT-042-BLE</a> | Pioneer kit     | PSoC™ 4200 Bluetooth® LE | CY8C4247LQI-BL483 |
| <a href="#">CY8CKIT-045S</a>    | Pioneer kit     | PSoC™ 4500S              | CY8C4548AZI-S485  |
| <a href="#">CY8CKIT-043</a>     | Prototyping kit | PSoC™ 4200M              | CY8C4247AZI-M485  |
| <a href="#">CY8CKIT-145</a>     | Prototyping kit | PSoC™ 4000S              | CY8C4045AZI-S413  |
| <a href="#">CY8CKIT-147</a>     | Prototyping kit | PSoC™ 4100PS             | CY8C4145LQI-PS433 |
| <a href="#">CY8CKIT-149</a>     | Prototyping kit | PSoC™ 4100S Plus         | CY8C4147AZI-S475  |

##### 6.1.3 Want to see the project in action?

If you do not want to go through the design process, you can get the completed PSoC™ Creator project using **Find Code Example** in PSoC™ Creator (**File > Code Example... > CE230991\_My\_First\_Project**). You can then jump to the [Build](#) and [Program](#) steps.

#### 6.2 About the design

This design simply blinks two LEDs using a TCPWM Component, as shown in [Figure 32](#). The TCPWM is configured in PWM mode. The two complementary outputs of this PWM control the LEDs. The PWM operates at a very low frequency and 50 percent duty cycle so that the toggling of the LEDs is visible. If you use a dual-color LED instead of two separate LEDs, this project can toggle the color of the dual-color LED.

6 My first PSoC™ 4 design using PSoC™ Creator

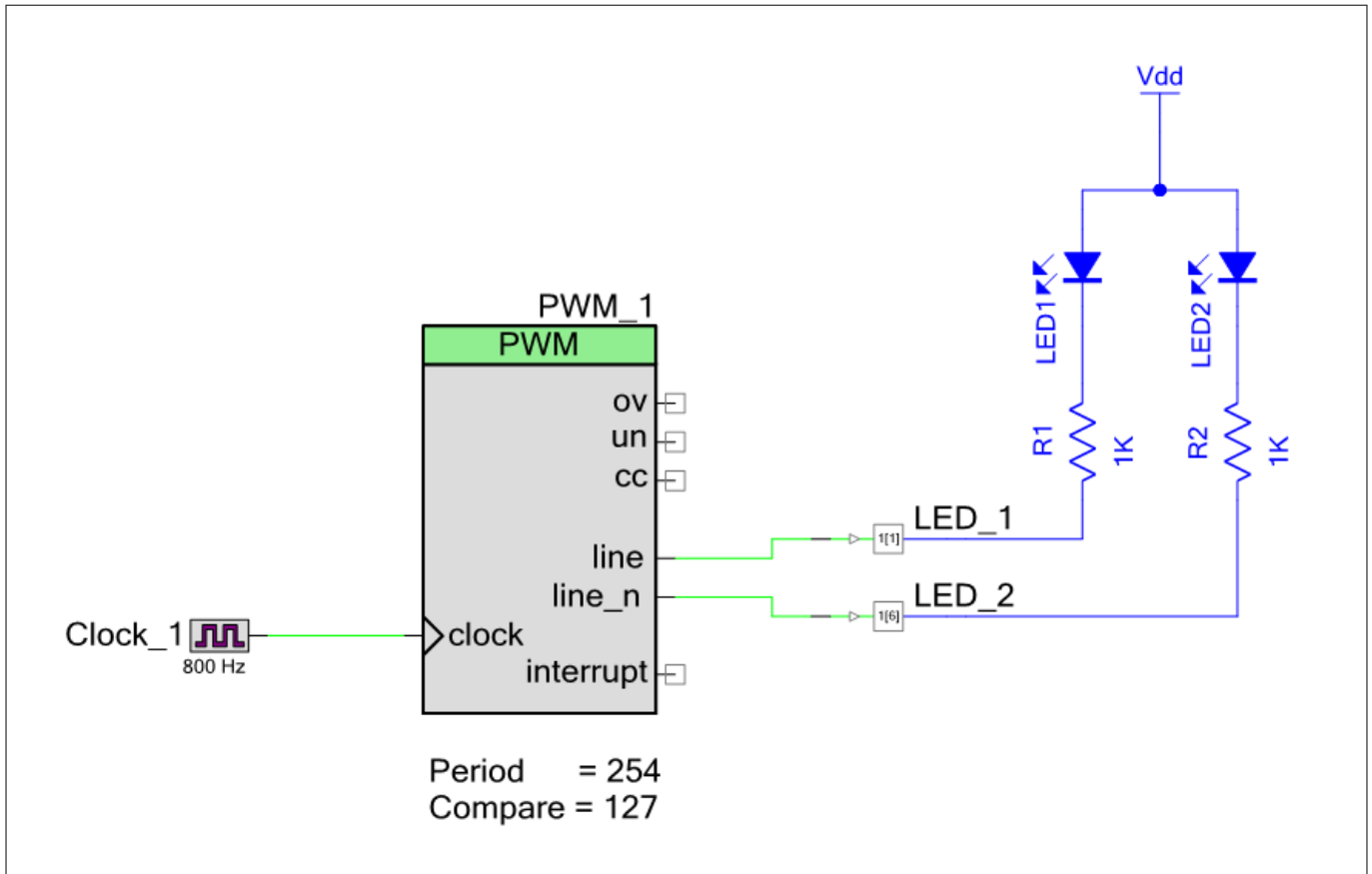

Figure 32 My first PSoC™ 4 design

6.3 Part 1: Create the design

This section takes you on a step-by-step guided tour of the design process. It starts with creating an empty project and guides you through hardware and firmware design entry.

- 1. Start PSoC™ Creator, and from the **File** menu choose **New > Project**, as shown in [Figure 33](#).

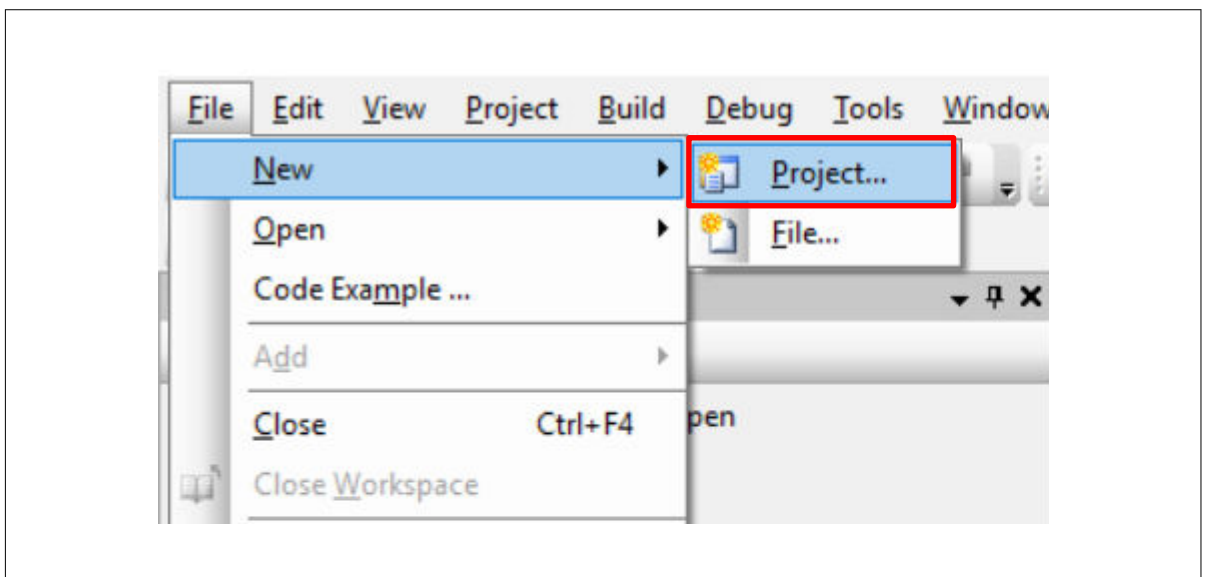

Figure 33 Creating a new project



## 6 My first PSoC™ 4 design using PSoC™ Creator

2. Select your development kit in the pop-up window. For example, if you have a CY8CKIT-149, select **Kit: CY8CKIT-149 (PSoC™ 4100S Plus)** and click **Next**. If you do not see your PSoC™ 4 development kit listed in the menu, download and install the kit setup for your kit from the website.

Alternately, you can also select the target device radio button instead of the target hardware and select the appropriate device and click **Next**.

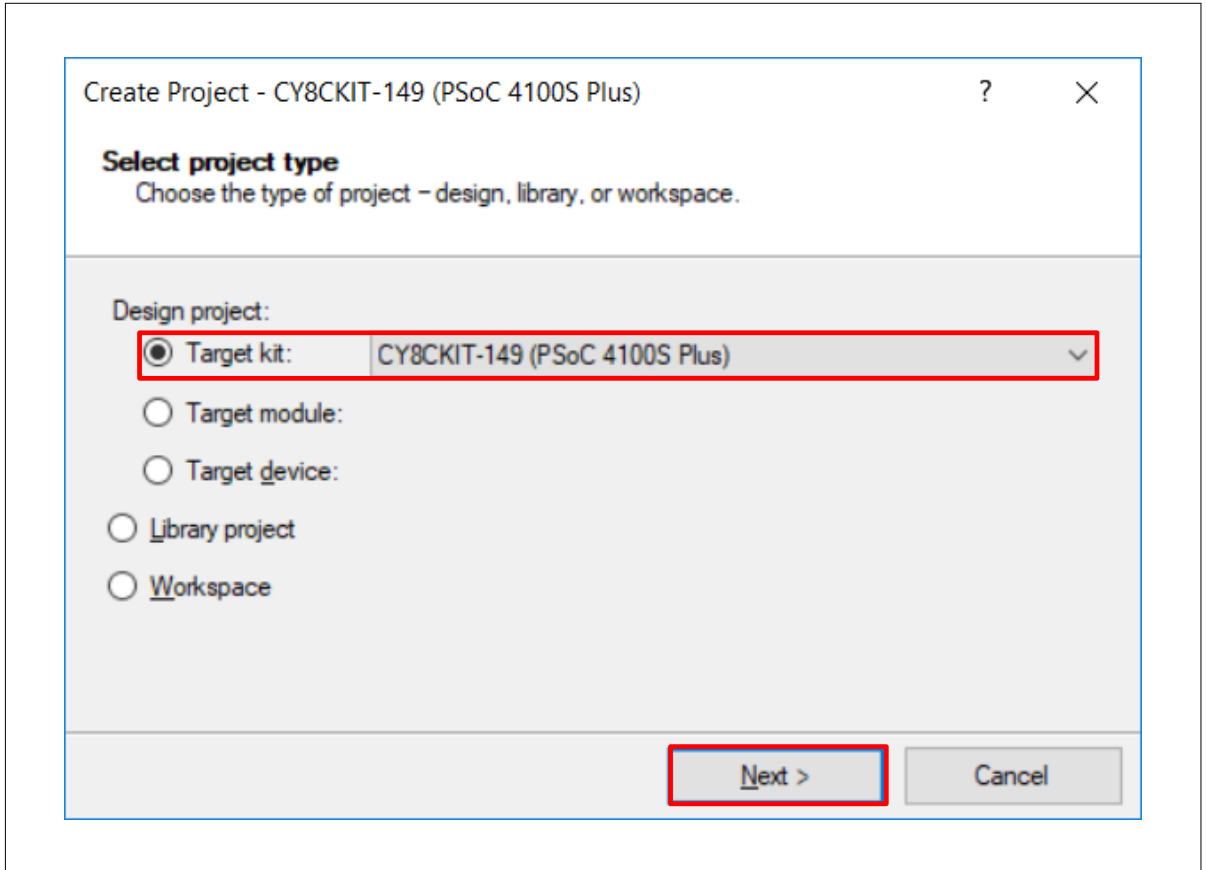

**Figure 34 Create a new empty PSoC™ 4 project**

3. Select the option **Empty Schematic** from the next window and click **Next**.

## 6 My first PSoC™ 4 design using PSoC™ Creator

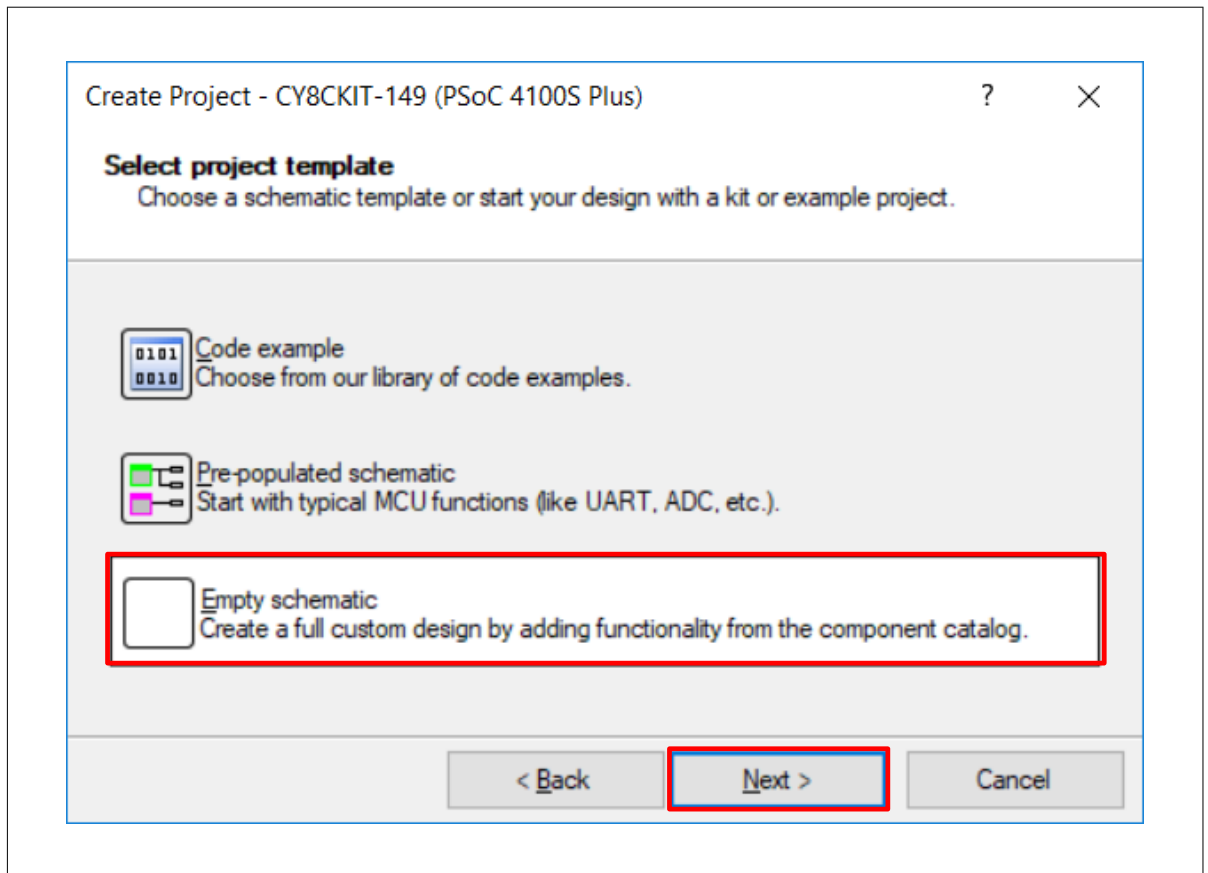

**Figure 35** Select empty schematic

4. Provide a project name (for example, "My\_First\_Project") and Workspace Name as shown in [Figure 36](#). Choose an appropriate location for your new project, and click **Finish**.

## 6 My first PSoC™ 4 design using PSoC™ Creator

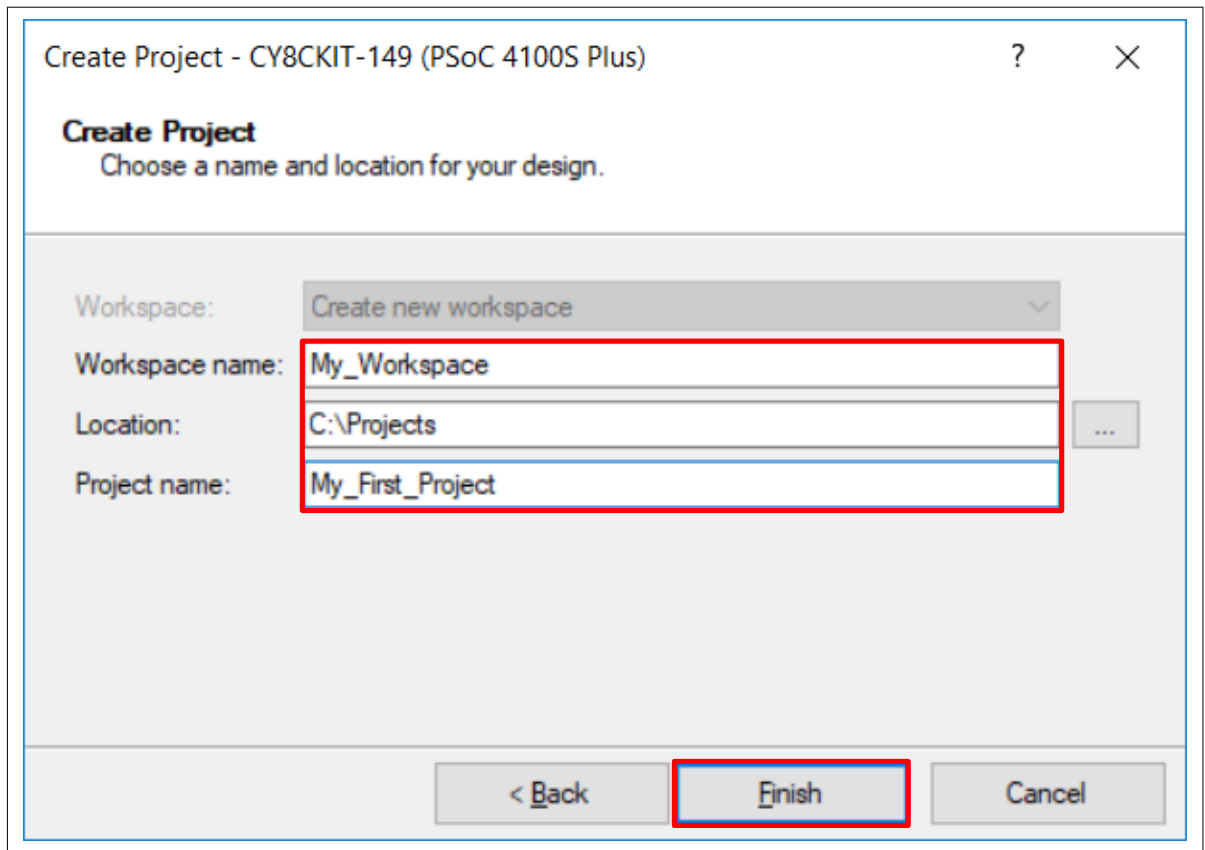

**Figure 36**                    **Selecting project name and location**

5. Creating a new project generates a project folder with a baseline set of files shown in the **Workspace Explorer** (see [Figure 37](#)). To open the project schematic file, double-click **TopDesign.cysch**.

## 6 My first PSoC™ 4 design using PSoC™ Creator

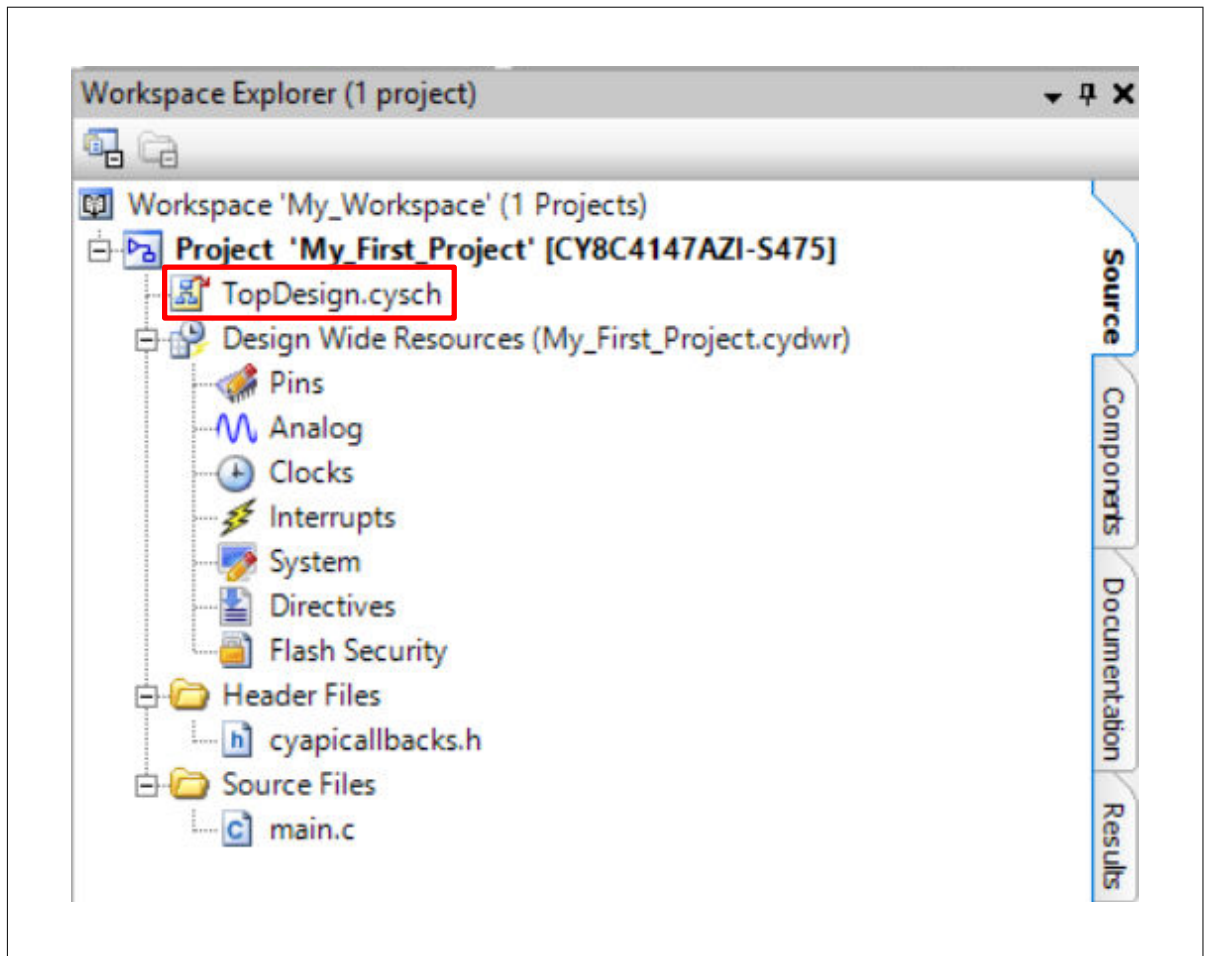

**Figure 37** Opening TopDesign schematic

6. Drag one PWM (TCPWM mode) Component from the Component Catalog onto the schematic, as shown in [Figure 38](#).

## 6 My first PSoC™ 4 design using PSoC™ Creator

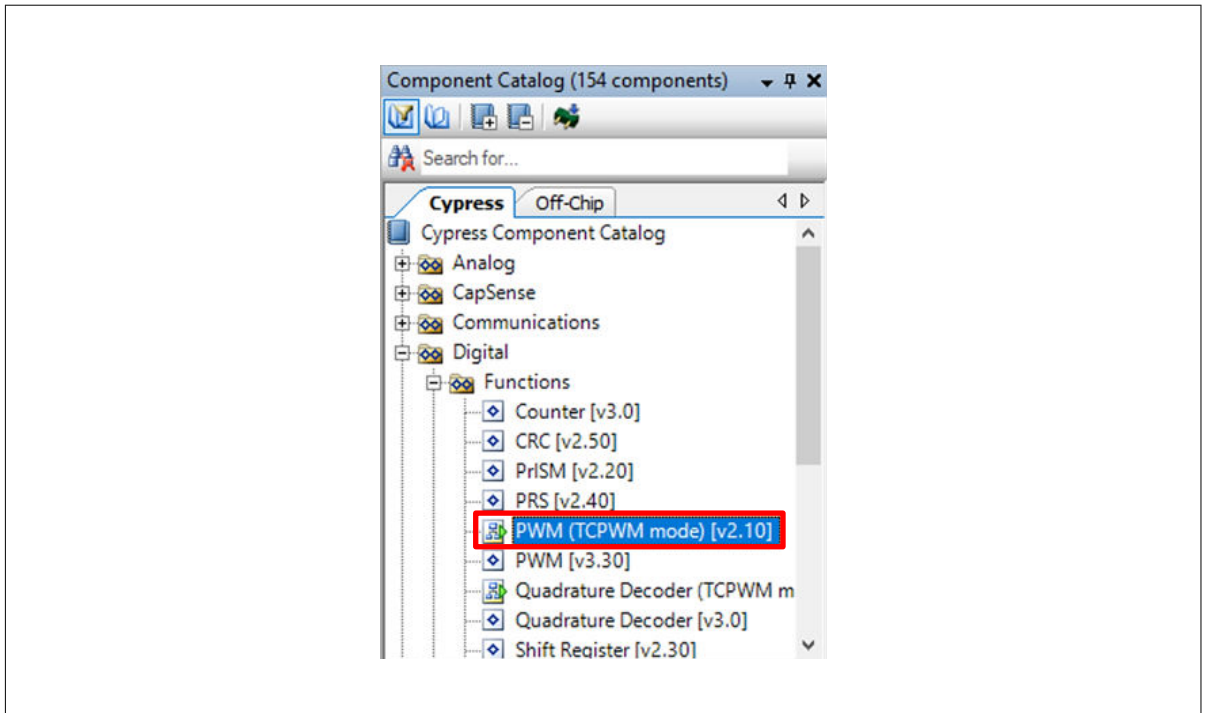

**Figure 38** Location of the PWM Component

7. Double-click the PWM Component on the schematic to configure the Component properties, as shown in [Figure 39](#). Click the **PWM** tab, and set the **Period** value to 254 and the **Compare** value to 127 to generate a PWM signal with a 50 percent duty cycle.  
Set the **Prescaler** to 8x, to divide the input clock frequency by 8.

6 My first PSoC™ 4 design using PSoC™ Creator

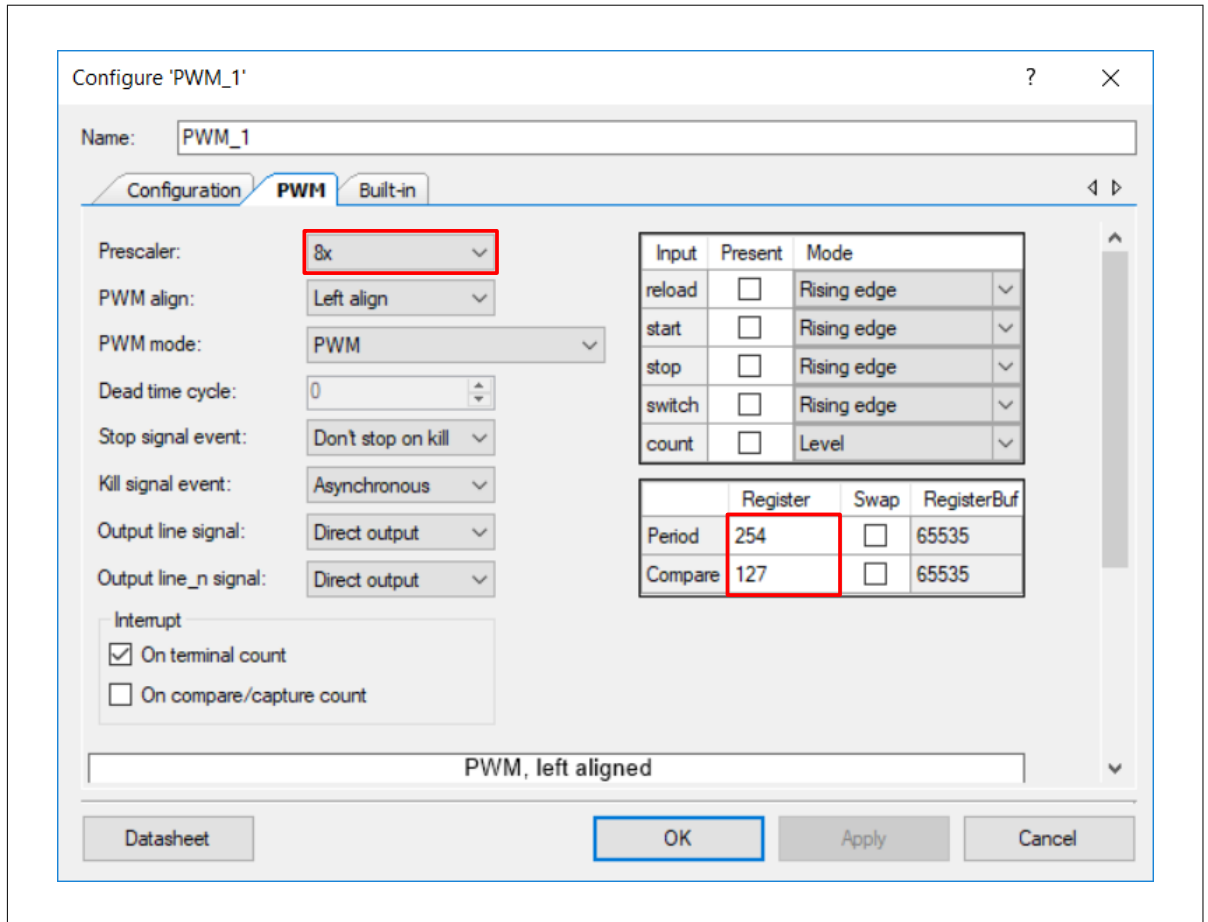

**Figure 39 Configuring the PWM Component**

- A PWM Component requires an input clock for its operation. Drag and drop a **Clock** Component onto the schematic, and configure the **Frequency** to 800 Hz by double-clicking on the Component, as shown in [Figure 40](#) and [Figure 41](#). Because the Prescaler value set in PWM Component is 8, the effective input clock of the PWM is only 100 Hz. Therefore, the PWM period of 254 results in a PWM output time period of 2.54 seconds.

6 My first PSoC™ 4 design using PSoC™ Creator

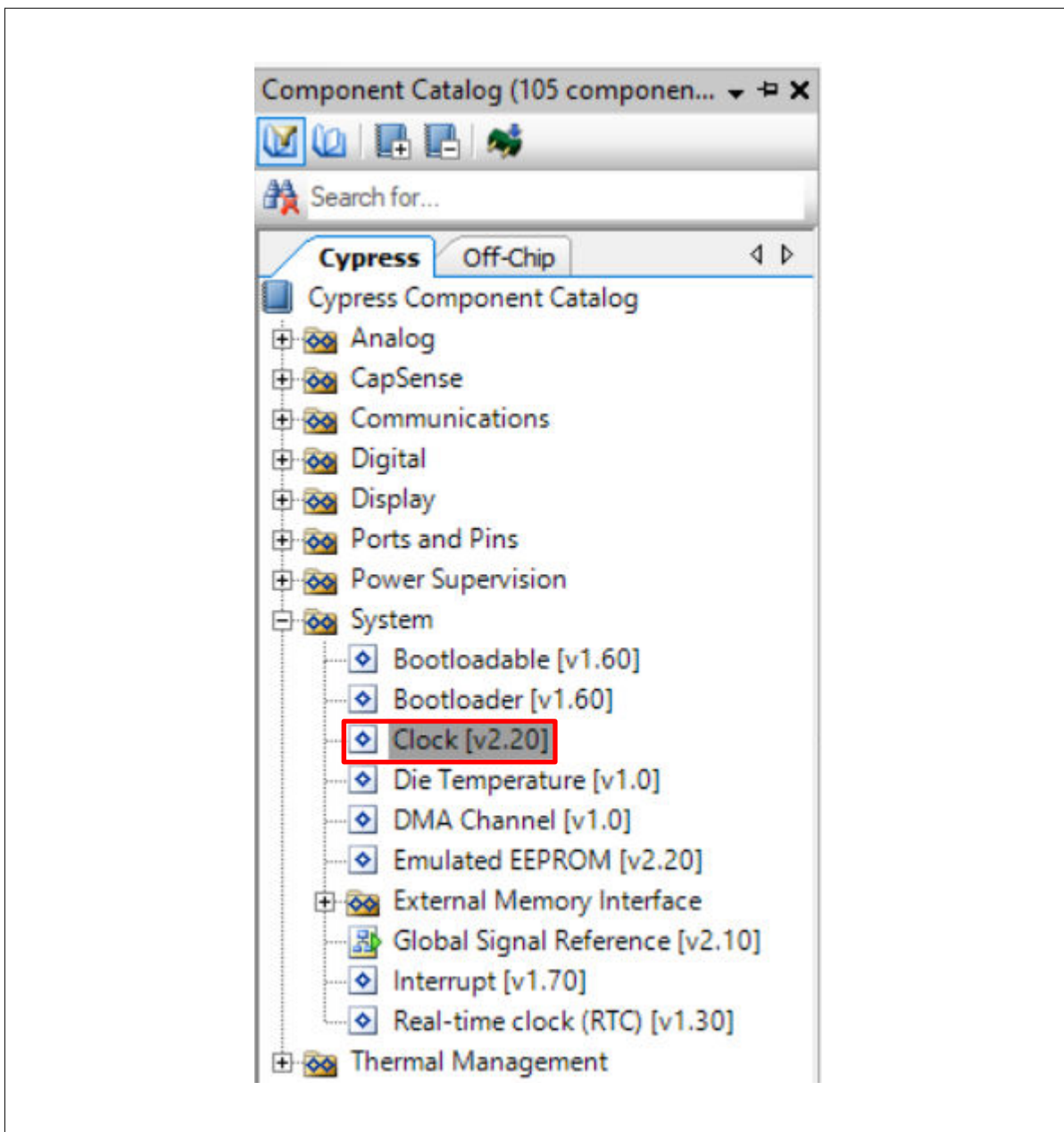

Figure 40 Location of the clock Component

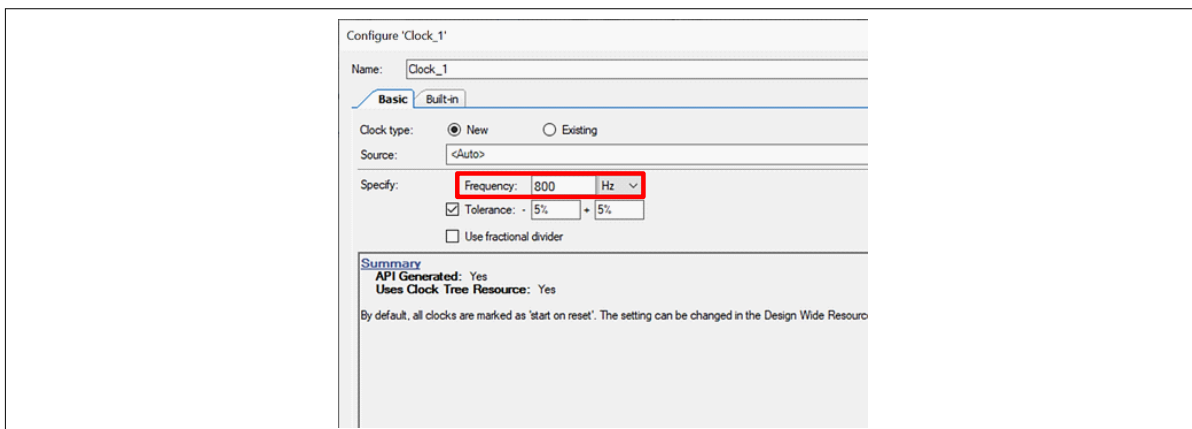
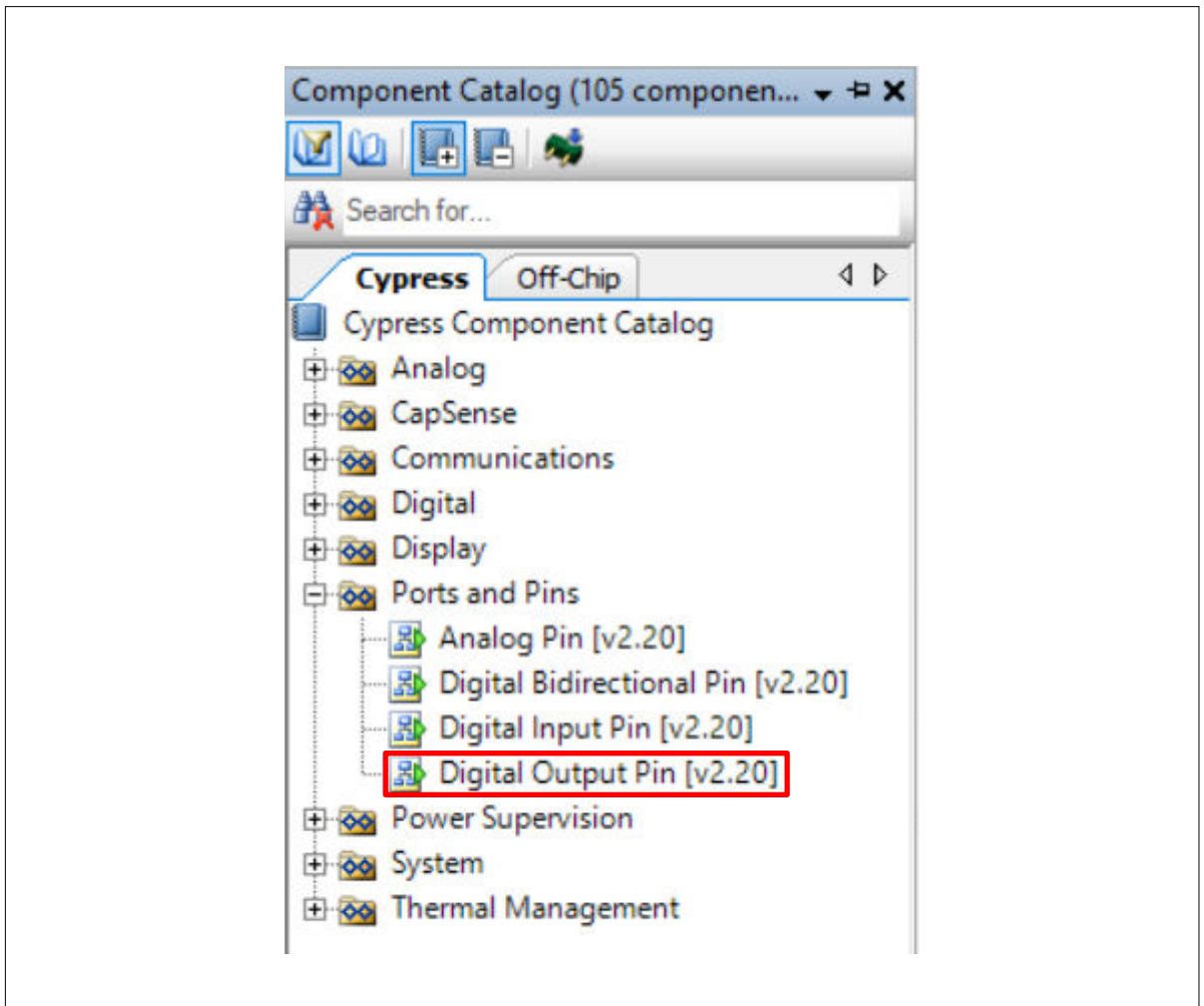

Figure 41 Configuring the clock Component

## 6 My first PSoC™ 4 design using PSoC™ Creator

9. Drag and drop a **Digital Output Pin** Component. Change the name to LED\_1 as shown in [Figure 42](#) and [Figure 43](#). Add another Digital Output Pin Component and change its name to LED\_2.



**Figure 42** Location of the digital output pin Component



6 My first PSoC™ 4 design using PSoC™ Creator

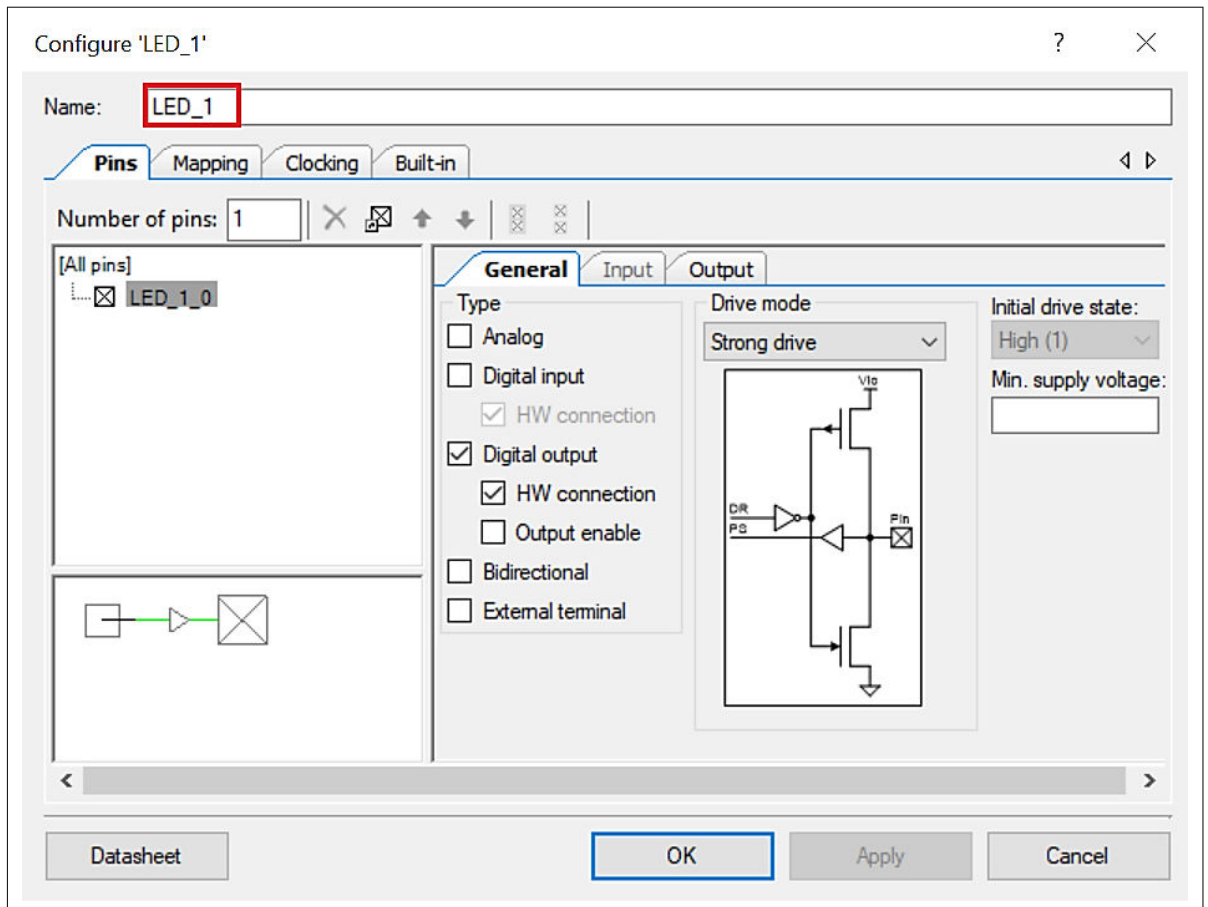

**Figure 43 Renaming a pin Component**

10. In the schematic window, select the wire tool as shown in Figure 44, or press **W**.

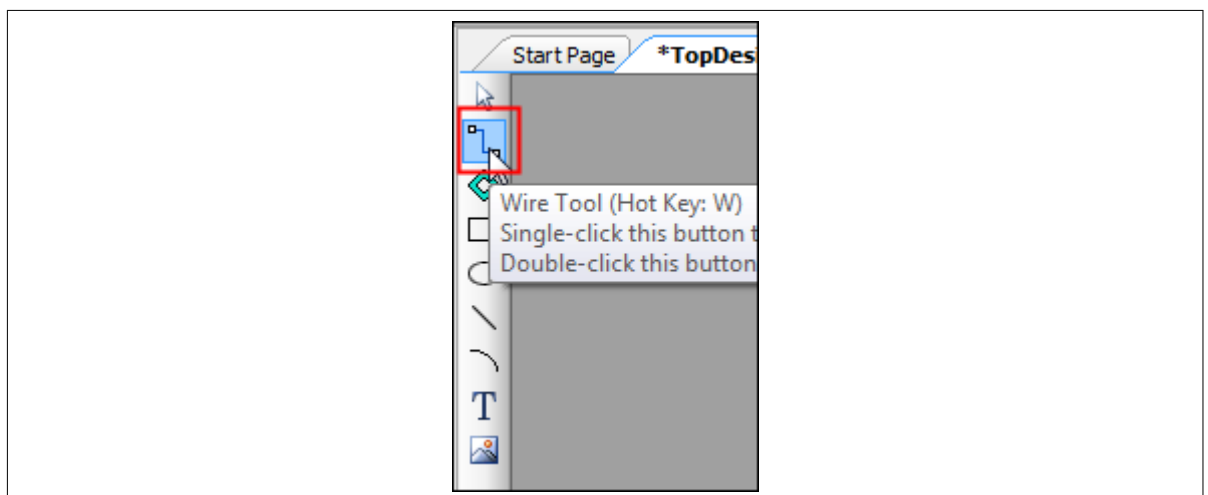

**Figure 44 Selecting the wire tool**

11. Wire the Components together, as shown in Figure 45.

6 My first PSoC™ 4 design using PSoC™ Creator

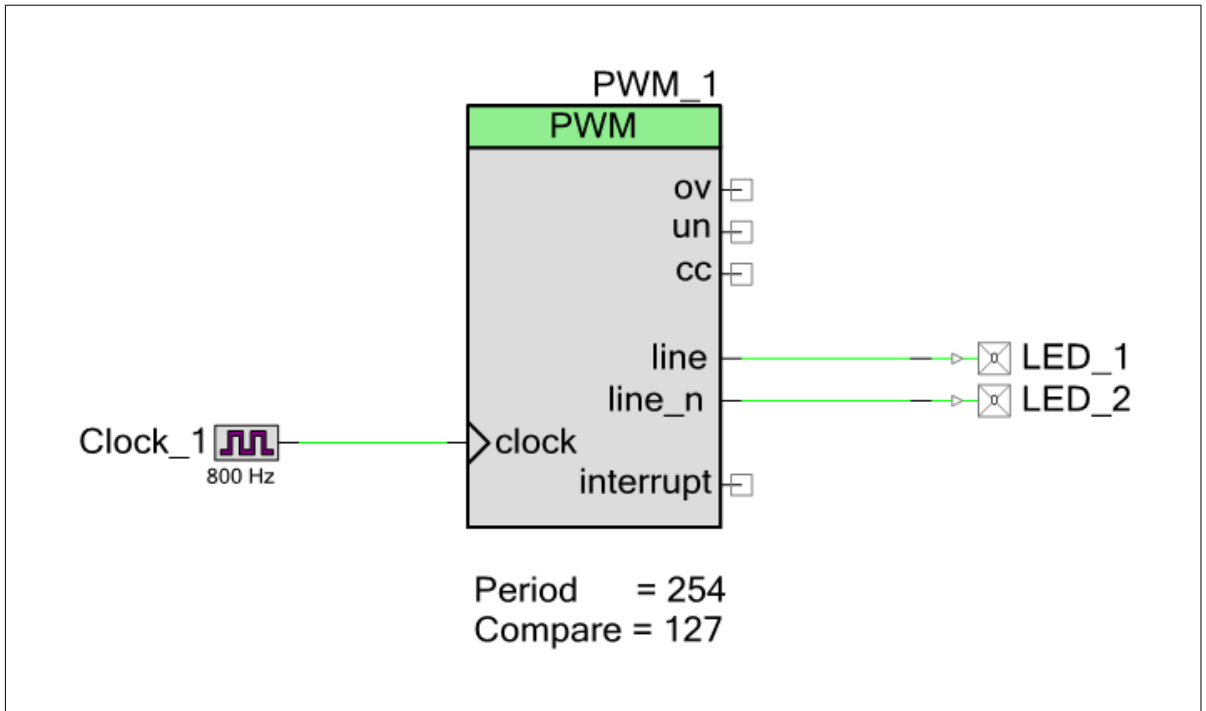

**Figure 45 Wiring the schematic**

- Most Components are disabled at device reset (the major exception being the Clock Component, which is automatically started as a default), and you must add code to the project to enable them. Open `main.c` from **Workspace Explorer** and add code to the `main()` function, as provided in [Code Listing 3](#).

**Code Listing 3 Enabling the PWM Component**

```

int main(void)
{
    /* Enable and start the PWM */
    PWM_1_Start();

    for(;;)
    {

    }
}
    
```

- Select **Build My\_First\_Project** from the Build menu. Note that PSoC™ Creator automatically generates source code files in the Workspace Explorer window for the PWM, Clock, and Digital Output Pin Components, as shown in [Figure 46](#).

6 My first PSoC™ 4 design using PSoC™ Creator

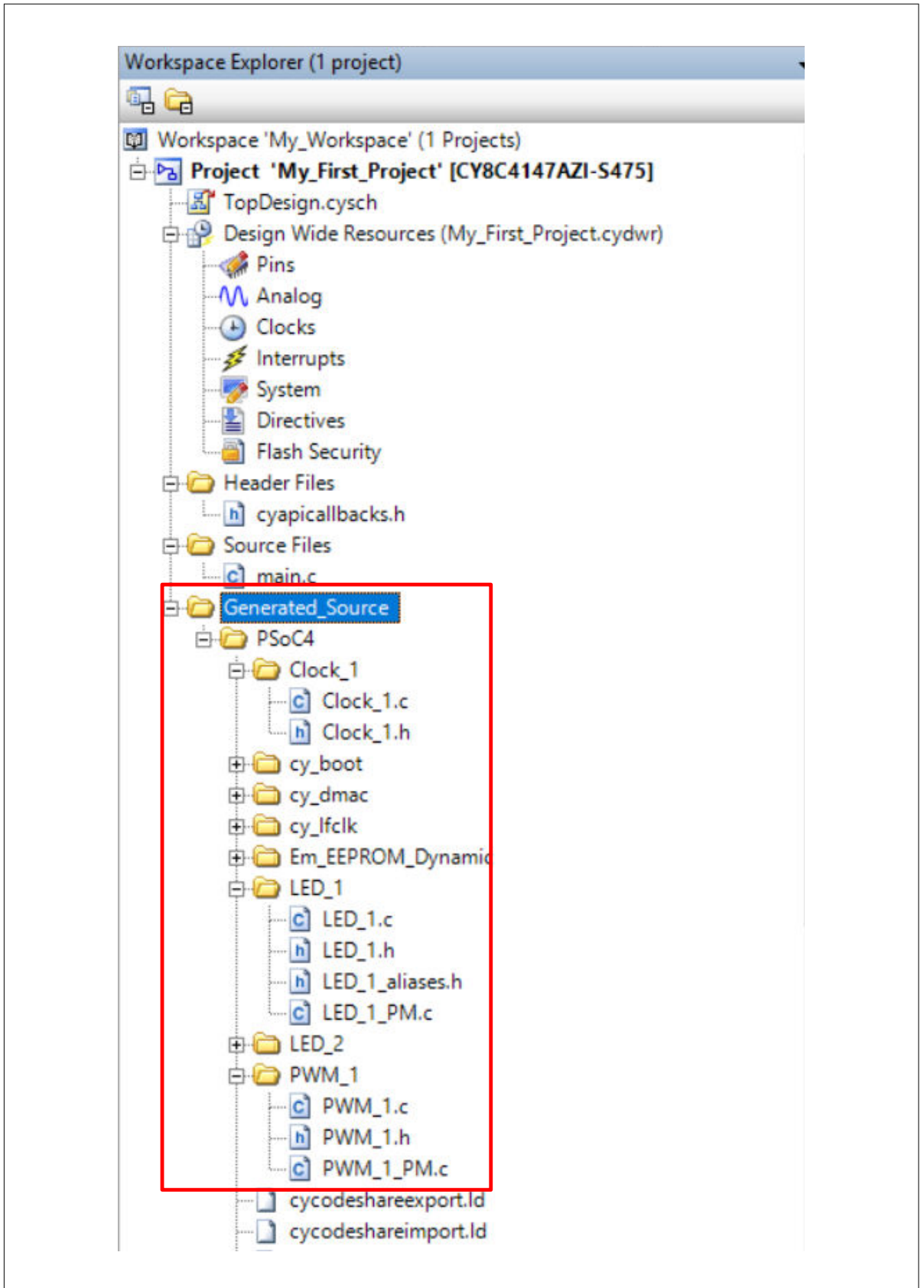

**Figure 46** Generated source files

- 14. Open the file `My_First_Project.cydwr` (Design-Wide Resource file) from **Workspace Explorer** and click the **Pins** tab. You can use this tab to select the device pins for the outputs LED\_1 and LED\_2.

6 My first PSoC™ 4 design using PSoC™ Creator

Figure 47 shows the pin configuration to connect the LED\_1 and LED\_2 pins to the LEDs in the CY8CKIT-149 PSoC™ 4 prototyping kit. See Table 11 if you are using a different PSoC™ 4 pioneer kit, or Table 12 if you are using a PSoC™ 4 prototyping kit.

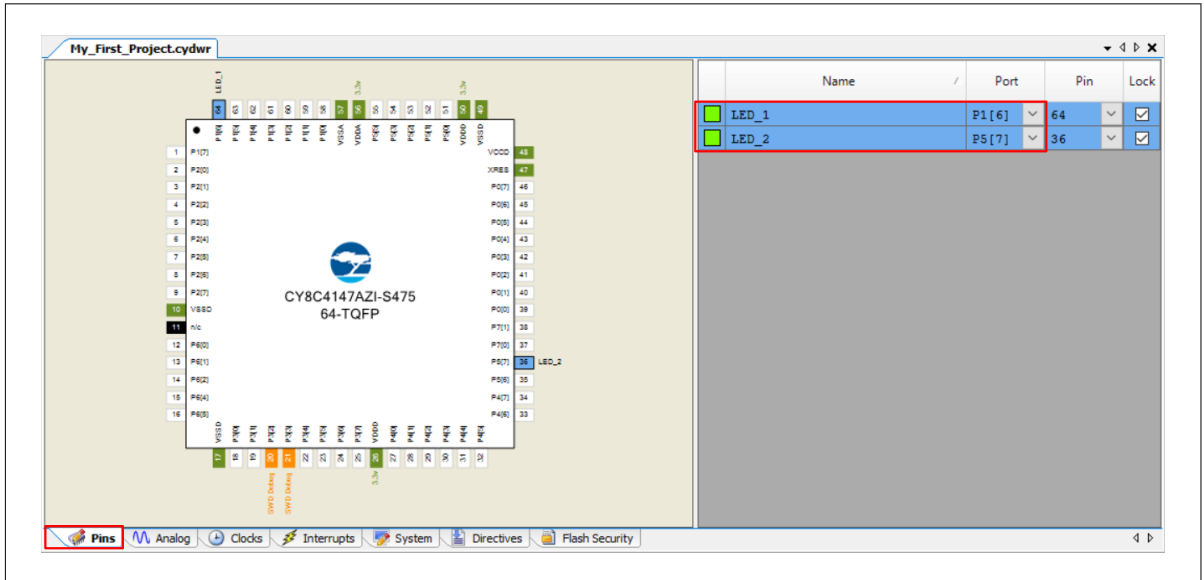

Figure 47 Pin selection

Table 11 Pin mapping table across pioneer kits

| Function               | CY8CKIT-040 (PSoC™ 4000) | CY8CKIT-041 (PSoC™ 4100S) | CY8CKIT-042 (PSoC™ 4200) | CY8CKIT-042- BLE (PSoC™ 4200 BLE) | CY8CKIT-044 (PSoC™ 4200M) | CY8CKIT-046 (PSoC™ 4200L) | CY8CKIT-045S (PSoC™ 4500S) |
|------------------------|--------------------------|---------------------------|--------------------------|-----------------------------------|---------------------------|---------------------------|----------------------------|
| Green LED (Active LOW) | P1[1]                    | P2[6]                     | P0[2]                    | P3[6]                             | P2[6]                     | P5[3]                     | P0[0]                      |
| Red LED (Active LOW)   | P3[2] <sup>9)</sup>      | P3[4] <sup>10)</sup>      | P1[6]                    | P2[6]                             | P0[6]                     | P5[2]                     | P1[6]                      |

Table 12 Pin mapping table across prototyping kits

| Function                       | CY8CKIT-145 (PSoC™ 4000S) | CY8CKIT-149 (PSoC™ 4100S Plus) |
|--------------------------------|---------------------------|--------------------------------|
| Green LED - LED 1 (Active LOW) | P3[4]                     | P1[6]                          |

(table continues...)

<sup>9</sup> PSoC™ 4000 parts have fixed pins for complementary PWM outputs – P1[1] and P1[6]. You cannot use any other pins for PWM outputs. See the device datasheet for more details. If you are using the CY8CKIT-040, you can use the green LED connected to P1[1], as LED1. To use the red LED as LED2, connect P3[2] from header J4 to P1[6] from header J3, using a wire. Alternately, you can connect an external LED to P1[6] as LED2.

<sup>10</sup> Similar to the note above, if you are using the CY8CKIT-041, you can use the green LED connected to P2[6], as LED1 and the complementary PWM output P2[7] for LED2. To use the red LED as LED2, connect P3[4] from header J2 to P2[7] from header J3, using a wire. Alternately, you can connect an external LED to P2[7] as LED2.

6 My first PSoC™ 4 design using PSoC™ Creator

**Table 12** (continued) Pin mapping table across prototyping kits

| Function                       | CY8CKIT-145 (PSoC™ 4000S) | CY8CKIT-149 (PSoC™ 4100S Plus) |
|--------------------------------|---------------------------|--------------------------------|
| Green LED - LED 2 (Active LOW) | P3[5]                     | P5[7]                          |

15. Finally, rebuild the project as explained in [Step 13](#).

**6.4 Part 2: Program the device**

This section explains how to program the device. Connect the kit board to your computer using the USB cable.

1. Select the PSoC™ Creator menu item **Debug > Select Debug Target**, as shown in [Figure 48](#).

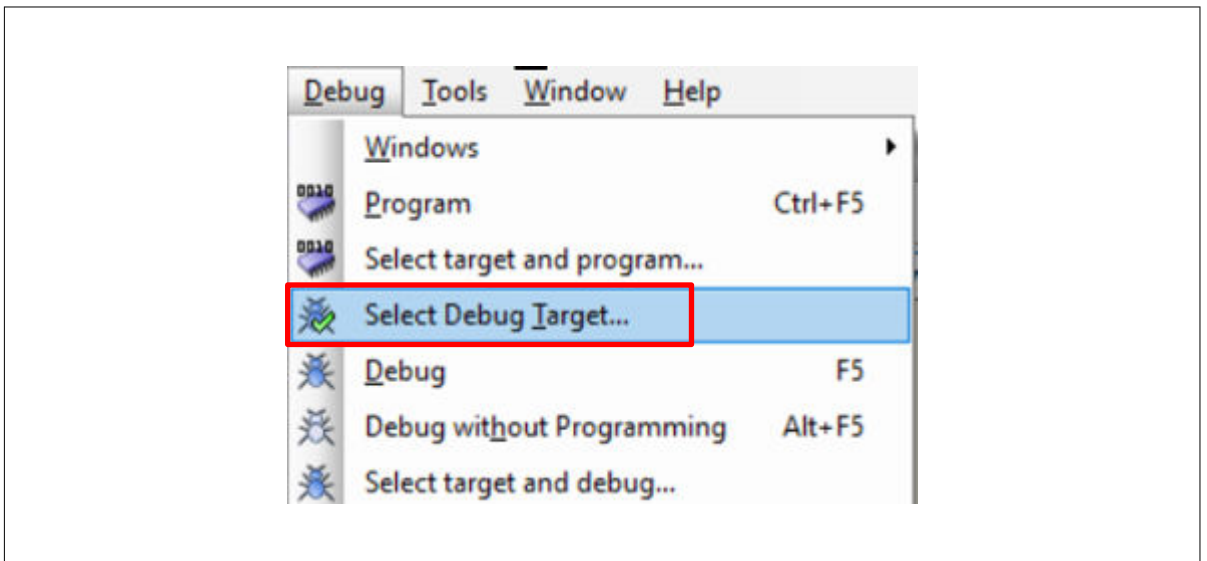

**Figure 48** Selecting debug target

2. In the **Select Debug Target** dialog box, click **Port Acquire**, and then click **Connect**, as shown in [Figure 49](#). Click **OK** to close the dialog box.

6 My first PSoC™ 4 design using PSoC™ Creator

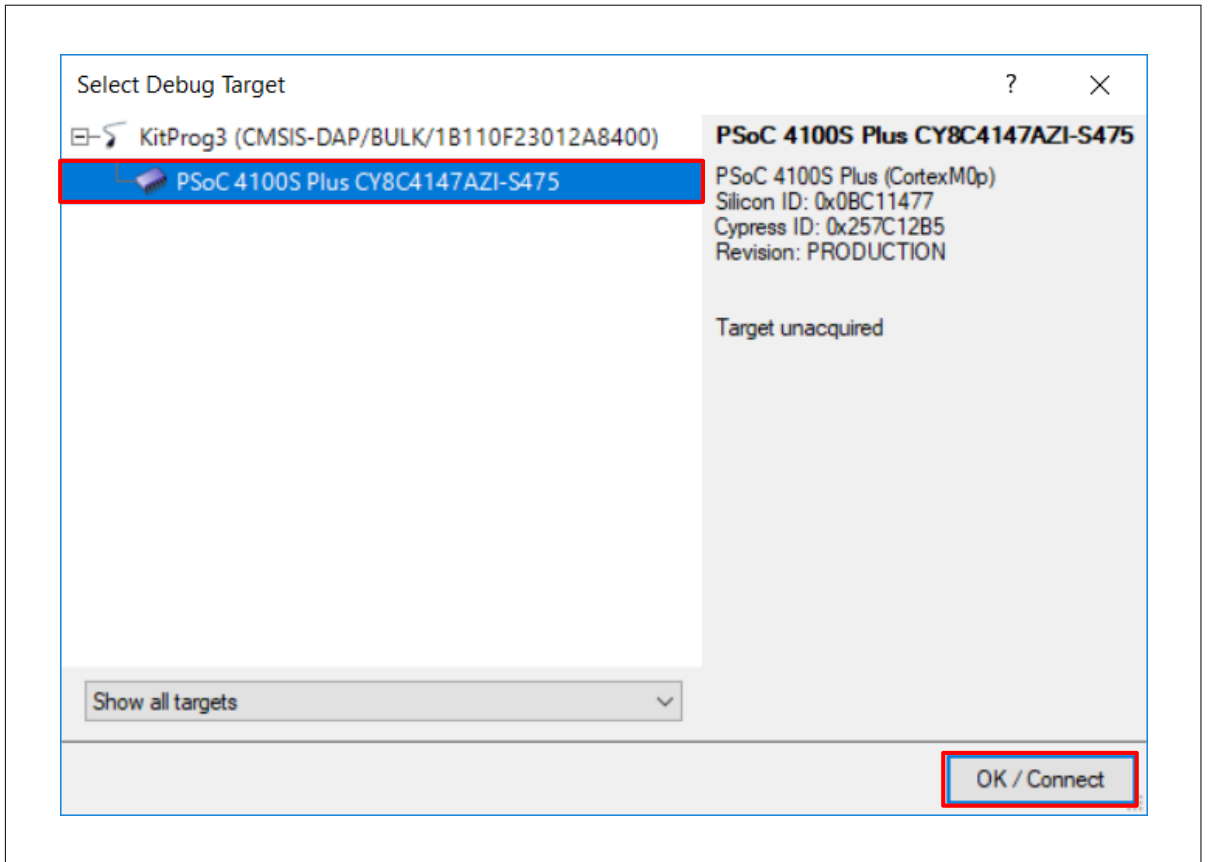

**Figure 49** Connecting to a device

- 3. Choose the menu item **Debug > Program** to program the device with the project, as shown in [Figure 50](#).

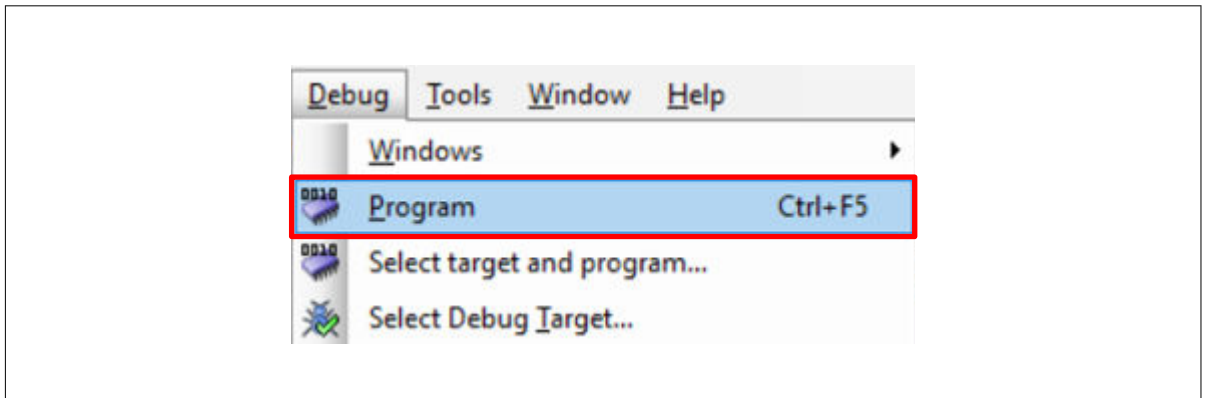

**Figure 50** Programming the device

- 4. You can view the programming status on the status bar (lower-left corner of the window), as shown in [Figure 51](#).

## 6 My first PSoC™ 4 design using PSoC™ Creator

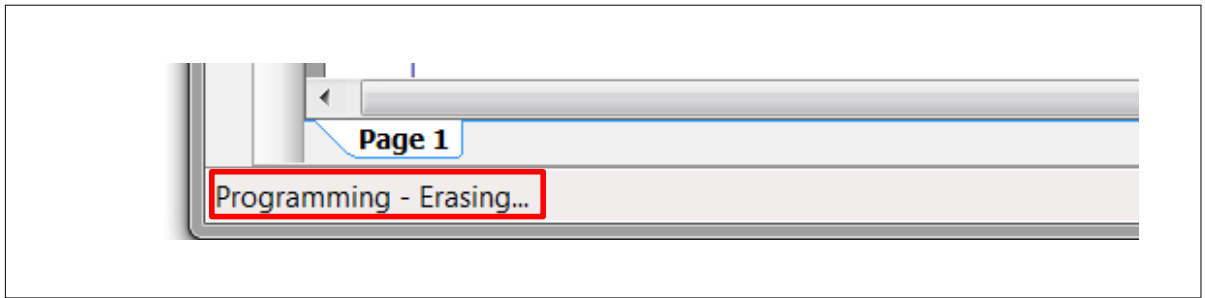

**Figure 51**      **Programming status**

5. After the device is programmed, ensure that the LEDs toggle, and confirm the working operation of the project.

---

## 7 Summary

### 7 Summary

This application note explored the PSoC™ 4 architecture and development tools. PSoC™ 4 is a truly programmable embedded system-on-chip, integrating configurable analog and digital peripheral functions, memory, and an Arm® Cortex®-M0/M0+ microcontroller on a single chip. Because of the integrated features and low-leakage power modes, PSoC™ 4 is an ideal choice for low-power and cost-effective embedded systems.

This application note also guided you to a comprehensive collection of resources to accelerate in-depth learning about PSoC™ 4.



---

## References

### References

- [1] [AN54181](#): Getting started with PSoC™ 3
- [2] [AN77759](#): Getting started with PSoC™ 5LP

---

**Revision history**
**Revision history**

| Document revision | Date       | Description of changes   |
|-------------------|------------|--|
| **                | 2013-01-24 | New Application Note   |
| *A                | 2013-04-11 | Demo project changed to leverage Pioneer kit.<br>Added architecture introduction.  |
| *B                | 2013-05-09 | Reformatted graphics. Updated links.   |
| *C                | 2013-12-19 | Updated attached Associated Project files.<br>Updated content across the entire document.<br>Updated in new template.  |
| *G                | 2014-04-10 | Updated the projects and the respective section in the AN to support PSoC™ Creator 3.0 SP1 and PSoC™ 4000 device.  |
| *H                | 2014-09-25 | Added Code Examples section.<br>Minor edits and format changes throughout the document.  |
| *I                | 2015-03-17 | Added More Information section.<br>Removed detailed feature descriptions.<br>Updated for PSoC™ 4200M family of devices.  |
| *J                | 2015-09-10 | Updated <a href="#">PSoC™ resources</a> and <a href="#">PSoC™ is more than an MCU</a> .<br>Added the following sections: Convert Project to Bootloadable for CY8CKIT-049, Bootload Your CY8CKIT-049, and More PSoC™ 4 Code Examples.<br>Updated <a href="#">Figure 8</a> .   |
| *K                | 2015-09-16 | Updated for PSoC™ 4200L.<br>Updated the example projects to PSoC™ Creator 3.3.   |
| *L                | 2015-12-30 | Updated the example projects to PSoC™ Creator 3.3 SP1.   |
| *M                | 2016-02-05 | Updated for PSoC™ 4000S and PSoC™ 4100S.<br>Updated the example projects to PSoC™ Creator 3.3 SP2.<br>Updated <a href="#">Table 10</a> , <a href="#">Table 11</a> to add PSoC™ 4200 BLE.   |
| *N                | 2017-04-19 | Updated logo and copyright   |
| *O                | 2017-10-06 | Added references to PSoC™ 4100S Plus throughout the document.<br>Updated <a href="#">Table 1</a> to add PSoC™ 4100S Plus.<br>Updated <a href="#">PSoC™ resources</a> with the reference of <a href="#">AN64846 - Getting Started with CAPSENSE™</a> .  |
| *P                | 2017-11-03 | Updated the example projects to PSoC™ Creator 4.2<br>Updated <a href="#">Table 1</a> to add supported kit<br>Updated <a href="#">Table 10</a> to add CY8CKIT-49, CY8CKIT-145 and CY8CKIT-149<br>Added <a href="#">Table 11</a> to include CY8CKIT-145 and CY8CKIT-149 pin mapping<br>Updated <a href="#">Figure 7</a> .<br>Added example project of CY8CKIT-145 and CY8CKIT-149 as a part of the <a href="#">AN79953.zip</a> file in this application note landing page. |
| *Q                | 2018-03-06 | Updated template<br>Updated for PSoC™ 4100PS<br>Minor edits and format changes throughout the document<br>Added example project of CY8CKIT-147 as a part of the <a href="#">AN79953.zip</a> file   |

---

**Revision history**

| Document revision | Date       | Description of changes   |
|-------------------|------------|--|
| *R                | 2018-05-04 | Updated template<br>Corrected the link to PSoC™ 4100S Plus in <a href="#">PSoC™ resources</a>  |
| *S                | 2019-09-06 | Updated Table 1 to add PSoC™ 4500 and update the specifications of PSoC™ 4100S Plus device family.<br>Added Motor Control Accelerator feature.   |
| *T                | 2020-11-09 | Updated for ModusToolbox™ support for some of the PSoC™ 4 devices.<br>Corrected the links in <a href="#">PSoC™ resources</a> .<br>PSoC™ 4 families are recategorized in <a href="#">Local sales office locations PSoC™ 4 feature set</a><br>Added new section My first PSoC™ 4 design using ModusToolbox™<br>Removed sections : Convert Project to Bootloadable for CY8CKIT-049, Bootload Your CY8CKIT-049, and More PSoC™ 4 Code Examples |
| *U                | 2021-07-08 | Updated to Infineon template<br>Updated Figure 2, Figure 3, Figure 4, and Figure 5 to the latest MTB 2.3 version<br>Updated document with PSoC™ 4100S Max device<br>Changed the default device to PSoC™ 4100S Max and updated <a href="#">Figure 8</a><br>Updated Modify the design section  |
| *V                | 2022-06-15 | Updated document with PSoC™ 4000T device<br>Updated with the latest release version of ModusToolbox™ (version-3.0)   |
| *W                | 2023-02-13 | Updated Folder structure with the latest release version of ModusToolbox™(VERSION-3.0)   |
| *X                | 2023-07-21 | Updated the pin changes for PSoC™ 4000T device<br>Updated content with the latest release of ModusToolbox™ 3.1   |
| *Y                | 2024-02-05 | Fixed broken links   |
| *Z                | 2024-02-26 | Updated content with the latest release of ModusToolbox™ 3.2   |

---

## Trademarks

### Trademarks

The Bluetooth® word mark and logos are registered trademarks owned by Bluetooth SIG, Inc., and any use of such marks by Infineon is under license.

## Trademarks

All referenced product or service names and trademarks are the property of their respective owners.

**Edition 2024-02-26**

**Published by**

**Infineon Technologies AG**

**81726 Munich, Germany**

**© 2024 Infineon Technologies AG**

**All Rights Reserved.**

**Do you have a question about any aspect of this document?**

**Email: [erratum@infineon.com](mailto:erratum@infineon.com)**

**Document reference**

**IFX-wxy1688450359599**

## Important notice

The information contained in this application note is given as a hint for the implementation of the product only and shall in no event be regarded as a description or warranty of a certain functionality, condition or quality of the product. Before implementation of the product, the recipient of this application note must verify any function and other technical information given herein in the real application. Infineon Technologies hereby disclaims any and all warranties and liabilities of any kind (including without limitation warranties of non-infringement of intellectual property rights of any third party) with respect to any and all information given in this application note.

The data contained in this document is exclusively intended for technically trained staff. It is the responsibility of customer's technical departments to evaluate the suitability of the product for the intended application and the completeness of the product information given in this document with respect to such application.

## Warnings

Due to technical requirements products may contain dangerous substances. For information on the types in question please contact your nearest Infineon Technologies office.

Except as otherwise explicitly approved by Infineon Technologies in a written document signed by authorized representatives of Infineon Technologies, Infineon Technologies' products may not be used in any applications where a failure of the product or any consequences of the use thereof can reasonably be expected to result in personal injury.